

MG3740A

Analog Signal Generator

100 kHz to 2.7 GHz

100 kHz to 4.0 GHz

100 kHz to 6.0 GHz



Excellent RF Performance Versatile Modulation Functions Built-in Dual RF Outputs*

Supports Narrowband Digital as well as CW and Analog Modulations!

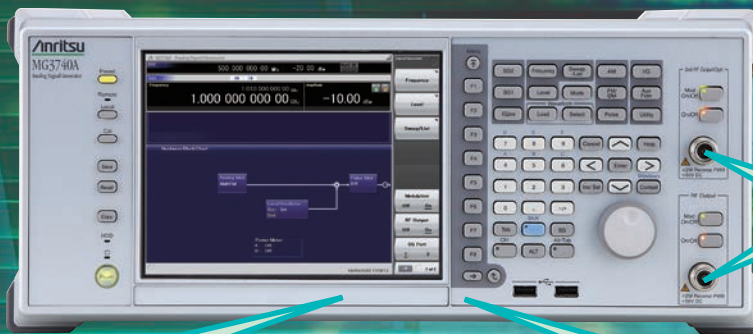

Dual RF*

Wanted + interference wave
Rx characteristics tests, Amp
intermodulation characteristics
evaluation, RF/LO signal source for
Mixer evaluations.

SSB Phase Noise Performance

< -140 dBc/Hz (nom.) [100 MHz, 20 kHz offset]
< -131 dBc/Hz (typ.) [1 GHz, 20 kHz offset]

Output Level Setting Range

-144 to +25 dBm [Option installed]

Analog/Pulse Modulation

Supports AM/FM/ΦM/Pulse modulation functions
as well as option for expansion to dual internal
modulation (AM/FM/ΦM) and single external
modulation systems.

*: Option installed

The MG3740A Analog Signal Generator has excellent RF specifications, including SSB Phase Noise, output level, etc., and versatile modulation functions (AM/FM/ΦM/Pulse).

High-Purity Signal Source for Testing Analog Radio

The excellent SSB phase noise performance supports narrowband radio Rx sensitivity suppression tests.

< -140 dBc/Hz (nominal) [100 MHz, 20-kHz offset, CW]

Excellent level accuracy over a wide level range, the MG3740A is the solution for accurate tests of radio Rx sensitivity and amplifier distortion characteristics.

Setting Range: -144 to +25 dBm
(CW, Opt. 041/071, 042/072, 043/073 installed)

Cuts Tact Time

To shorten tact times on production lines the MG3740A supports two standard modes.

The List/Sweep mode switches the frequency and level faster than 600 μs.

Cut Equipment Costs

The dual RF outputs supporting wanted + interference waves for tests of Rx characteristics, evaluation of wireless and amplifier intermodulation characteristics, and output of RF/LO signals for mixer tests, cut test costs by eliminating the need for two signal generators.

Extendible Narrowband Digital Modulation Function

Adding the digital modulation option adds a digital modulation signal generator function providing a cost-effective solution for testing public safety digital radio systems.

- Digital Modulation Performance
- RF Modulation Bandwidth : 2 MHz
 - Sampling Rate : 20 kHz to 8 MHz

Main Applications

- Testing Rx characteristics of analog radio
- Testing amplifier distortion and intermodulation characteristics
- RF/LO Signal source for evaluating mixer characteristics
- Testing Rx characteristics of narrowband digital radio

Key Features

Basic Performance

- **SSB Phase Noise Performance**
<-140 dBc/Hz (nom.) @100 MHz, 20-kHz offset, CW
<-131 dBc/Hz (typ.) @1 GHz, 20-kHz offset, CW
<-125 dBc/Hz (typ.) @2 GHz, 20-kHz offset, CW
- **High-power Output [Opt. 041/071]**
+23 dBm @CW, 400 MHz to 3 GHz
- **High-speed Switching**
< 600 μ s @List/Sweep mode
- **High Level Accuracy**
Absolute Level Accuracy: ± 0.5 dB
Linearity: ± 0.2 dB (typ.)
- **Choice of Reference Oscillators**
- Standard
Aging rate $\pm 1 \times 10^{-6}$ /year, $\pm 1 \times 10^{-7}$ /day
- High Stability Reference Oscillator [Opt. 002]
Aging rate $\pm 1 \times 10^{-7}$ /year, $\pm 1 \times 10^{-8}$ /day
- Rubidium Reference Oscillator [Opt. 001]
Aging rate $\pm 1 \times 10^{-10}$ /month

Dual RF

- **One Unit Supports Two RF Outputs Max.**
- Frequency Range
 - 1stRF: 100 kHz to 2.7 GHz [Opt. 032]
100 kHz to 4.0 GHz [Opt. 034]
100 kHz to 6.0 GHz [Opt. 036]
 - 2ndRF: 100 kHz to 2.7 GHz [Opt. 062]
100 kHz to 4.0 GHz [Opt. 064]
100 kHz to 6.0 GHz [Opt. 066]
- Independent Baseband and RF Outputs

Expandability

- **Analog/Pulse Modulation Functions [Standard]**
Supports built-in analog modulation (AM/FM/ Φ M) functions and pulse modulation (PM) functions.
Adding additional analog modulation input options (Opt. 050/080) supports modulation by external signal input.
- **USB Power Sensors [Sold separately]**
Up to two USB power sensors can be connected to the MG3740A and the results are displayed on the MG3740A screen.
- Frequency Range: 600 MHz to 4 GHz [MA24104A]*
350 MHz to 4 GHz [MA24105A]
50 MHz to 6 GHz [MA24106A]
10 MHz to 8 GHz [MA24108A]
10 MHz to 18 GHz [MA24118A]
10 MHz to 26 GHz [MA24126A]

*: MA24104A has been discontinued. Replacement model is MA24105A.

Operability

- **Simple Touch-panel Operation**
Touching the easy-to-use GUI with hierarchical menus fetches related function and numeric input keys for simple fast settings.
- **Signal Flowcharts with Signal Block Diagrams**
Intuitive Hardware Block Chart screens make it easy to grasp settings and signal paths at a glance.
- **Frequency Channel Table**
A built-in channel table with presettings for popular communications systems simplifies frequency settings by using channel numbers.

Connections with External Equipment

- **Remote Control Interfaces**
GPIB, Ethernet (1000BASE-T), and USB (Type B) interfaces on the rear panel offer versatile choices for operation by remote control.
- **USB Connections**
Two Type A USB2.0 connectors on each of the front and rear panels offer convenient connections for keyboard, mouse and USB memory.

Expansion to Digital Modulation Signal Generator

The MG3740A Analog Signal Generator can be expanded to add digital modulation signal generation functions, supporting evaluation of digital public safety radio systems.

- **Digital Modulation [Opt. 020]**
Adding the digital modulation option [Opt. 020] supports generation of digital modulation signals by outputting narrowband digital modulation signals.
- Digital Modulation Performance
 - RF Modulation Bandwidth : 2 MHz
 - Sampling Rate : 20 kHz to 8 MHz
- Waveform generation software: IQproducer (License sold separately)
 - TDMA IQproducer
 - Fading IQproducer
- **BER Test Function [Opt. 021]**
This option measures Bit Error Rate (BER) using Data/Clock/Enable demodulated at the DUT to display the results on the MG3740A screen.
 - Input bit rate: 100 bps to 40 Mbps
- **Output Two Signals from One RF Out [Opt. 048/078]**
The baseband signal combine option installs two waveform memories for either the 1stRF (or 2ndRF) SG to combine two waveform patterns as the baseband for output, eliminating the need for two separate signal generators.
 - Wanted Signal + Interfere Signal
 - Wanted Signal + Delayed Signal, etc.

Basic Performance

SSB Phase Noise

- <-140 dBc/Hz (nom.) @100 MHz, 20-kHz offset, CW
- <-131 dBc/Hz (typ.) @1 GHz, 20-kHz offset, CW
- <-125 dBc/Hz (typ.) @2 GHz, 20-kHz offset, CW

SSB phase noise is an important performance index for signal generators. For example, when using a signal generator for the following purposes, it is important to pre-confirm that the signal generator performance satisfies the measurement specifications.

- Communications with narrow bandwidth of several kHz
- CW interference waveforms
- Full range of reference and local signals

Single sideband phase noise

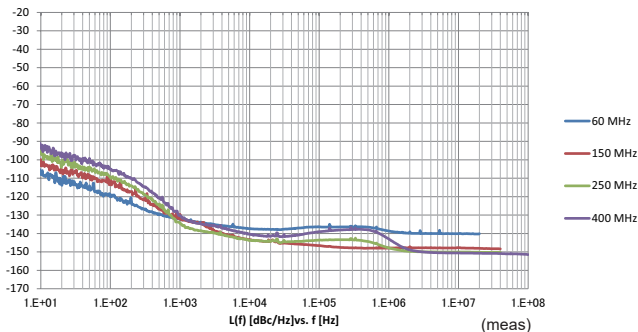

Single sideband phase noise

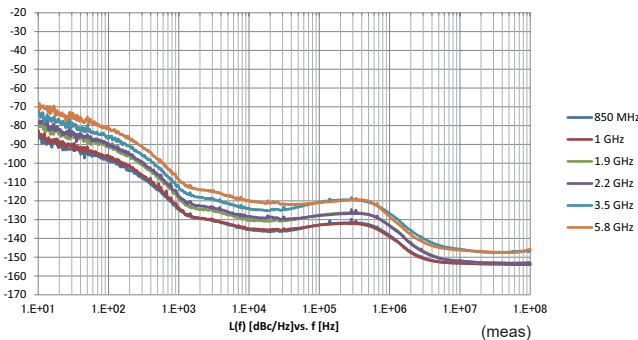

Example: SSB Phase Noise

(Phase Noise Optimization <200 kHz, CW, Optimize S/N Off, with Opt. 002)

Low-power Output [Opt. 042*1/072*2]

- *1: Low Power Extension for 1stRF [Opt. 042]
- *2: Low Power Extension for 2ndRF [Opt. 072]

• Amplitude Setting Range

Options	Setting Range [dBm]	
	without Reverse Power Protection*3	with Reverse Power Protection*3
Standard	-110 to +17	-110 to +17
with High-power Extension	-110 to +30	-110 to +25
with Low-power Extension	-144 to +17	-144 to +17
with High-power Extension and Low-power Extension	-144 to +30	-144 to +25

*3: Reverse Power Protection for 1stRF/2ndRF [Opt. 043/073]

The MG3740A supports a convenient option for extending the lower RF output limit when performing high-sensitivity Rx tests.

High-power Output [Opt. 041*1/071*2]

- *1: High Power Extension for 1stRF [Opt. 041]
- *2: High Power Extension for 2ndRF [Opt. 071]

Level Accuracy is assured at high levels (CW)

Frequency Range	Standard	Opt. 041/071
100 kHz ≤ f < 10 MHz	+5 dBm	+5 dBm
10 MHz ≤ f < 50 MHz	+10 dBm	+10 dBm
50 MHz ≤ f < 400 MHz	+13 dBm	+20 dBm
400 MHz ≤ f ≤ 3 GHz		+23 dBm
3 GHz < f ≤ 4 GHz		+20 dBm
4 GHz < f ≤ 5 GHz		+13 dBm
5 GHz < f ≤ 6 GHz	+11 dBm	+11 dBm

These options expand the MG3740A RF output upper limit. They are used when compensating for level losses of parts in the measurement path.

Maximum output power

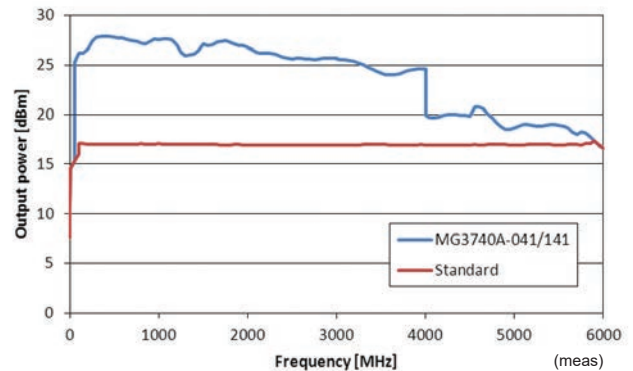

Supports Rubidium Reference Oscillator (Option)

Three reference oscillator options are supported. Select the high-stability reference oscillator option [Opt. 002] when requiring high accuracy depending on the measurement conditions; for even higher accuracy, select the rubidium reference oscillator [Opt. 001]. However, if external high-accuracy reference signals are available, selecting the standard reference oscillator option helps reduce unnecessary costs.

• Reference Oscillator

• Standard

Aging Rate: $\pm 1 \times 10^{-6}$ /year, $\pm 1 \times 10^{-7}$ /day
Temperature Stability: $\pm 2.5 \times 10^{-6}$ (5° to 45°C)

• High Stability Reference Oscillator [Opt. 002]

Aging Rate: $\pm 1 \times 10^{-7}$ /year, $\pm 1 \times 10^{-8}$ /day
Temperature Stability: $\pm 2 \times 10^{-8}$ (5° to 45°C)
Start-up Characteristics*: $\pm 5 \times 10^{-7}$ (2 minutes after power-on)
 $\pm 5 \times 10^{-8}$ (5 minutes after power-on)

• Rubidium Reference Oscillator [Opt. 001]

Aging Rate: $\pm 1 \times 10^{-10}$ /month
Temperature Stability: $\pm 2 \times 10^{-9}$ (5° to 45°C)
Start-up Characteristics*: $\pm 1 \times 10^{-9}$ (7.5 minutes after power-on)

*: Compared to frequency after 24-h warm-up at 23°C

High Level Accuracy

Absolute Level Accuracy: ± 0.5 dB*¹

Linearity: ± 0.2 dB (typ.)*²

*1: 400 MHz to 3 GHz, -110 to +10 dBm

*2: 50 MHz to 3 GHz, -110 to -1 dBm

Excellent level accuracy and linearity are key factors with a large impact on measurement accuracy.

Level accuracy at 0dBm

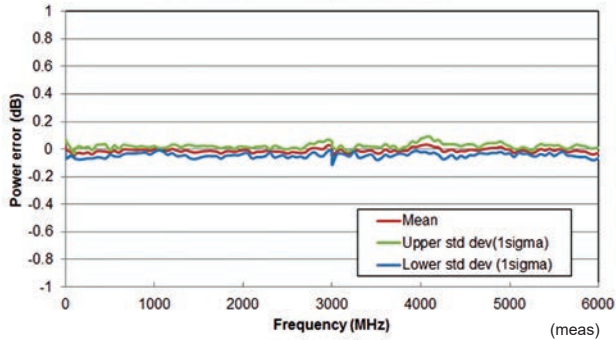

Relative level accuracy at 850 MHz initial power +10 dBm

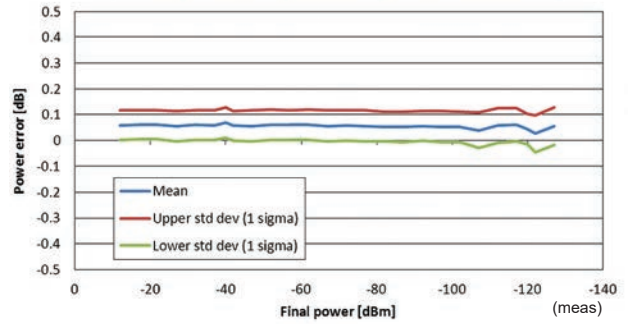

Linearity

Level accuracy at -112 dBm

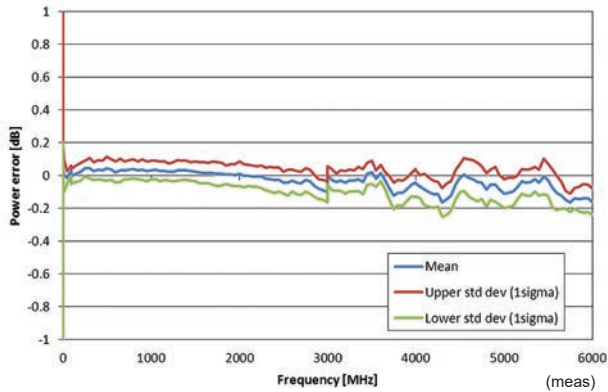

Frequency Characteristic

Amplitude repeatability +5 dBm ALC on

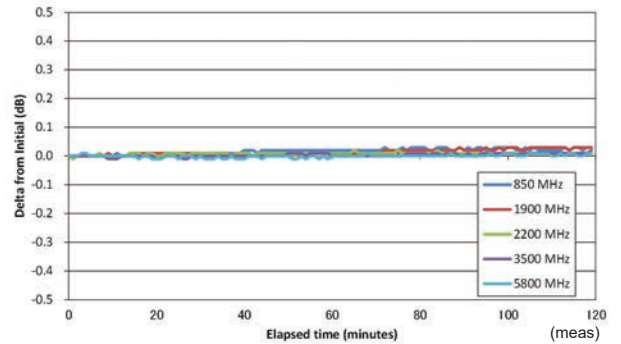

Aging

High-speed Switching

<600 μ s @List/Sweep mode

To shorten tact times on production lines the MG3740A supports two standard modes each with high-speed frequency and level switching.

• Sweep Mode

In this mode, the dwell time per point or number of points is split between the frequency range and level range (Start/Stop). This mode is used when matching dwell time per point and frequency/level steps.

Frequency Range

Level Range

Points:
2 to 1000 (Sawtooth)
2 to 500 (Triangle)

Dwell Time:
100 μ s to 16 s

Step Shape:
Sawtooth
Triangle

Triangle

SawTooth

10 points, 500- μ s Dwell Time

• List Mode

In this mode, the frequency, level and dwell time can be set for each of up to 500 points. This mode is used when wanting to set any dwell time, and frequency/level step per point.

Freq	Frequency	Level	Dwell
1	400.000000 MHz	-10.00 dBm	500 μ s
2	450.000000 MHz	-20.00 dBm	2 ms
3	500.000000 MHz	-30.00 dBm	2 ms
4	550.000000 MHz	-30.00 dBm	2 ms
5	600.000000 MHz	-30.00 dBm	5 ms

5 points, Any Dwell Time

Dual VSG: Two RF Outputs

The MG3740A supports two RF outputs (1stRF/2ndRF) max. in one unit. Moreover, different frequencies can be set independently at 1stRF and 2ndRF.

Not only different frequencies but also different levels and modulations can be set independently at each SG while each is tracking the other. The all-in-one MG3740A eliminates the need for two conventional signal generators when requiring wanted + interference waveforms for evaluating Rx signal characteristics, testing intermodulation characteristics of radio equipment and amplifiers, and generating RF/LO signals for evaluating mixers.

Notes: Supported frequency bands cannot be changed after shipment. IQ input is supported only by SG1 (1stRF) and requires Opt. 017.

2ndRF
Frequency Range:
100 kHz to 2.7 GHz [Opt. 062]
100 kHz to 4.0 GHz [Opt. 064]
100 kHz to 6.0 GHz [Opt. 066]
* Whether or not install and the frequency model can be selected at any time.

1stRF
Frequency Range:
100 kHz to 2.7 GHz [Opt. 032]
100 kHz to 4.0 GHz [Opt. 034]
100 kHz to 6.0 GHz [Opt. 036]
* Must install any one of these.

Expandability

AM/FM/ΦM/Pulse Function

This option supports the following modulation functions as standard. Analog modulation (AM/FM/ΦM) is supported using both CW and internal modulation signals.

Pulse modulation can be performed at any cycle or timing and also supports modulation using an external input signal.

- **Amplitude Modulation (Internal Modulation Source)**

- Depth: 0 to 100% (Linear)
0 to 10 dB (Exponential)
- Modulation Frequency: 0.1 Hz to 50 MHz

- **Frequency Modulation (Internal Modulation Source)**

- Deviation: 0 to 40 MHz
- Modulation Frequency: 0.1 Hz to 40 MHz, or (50 MHz-FM Rate), whichever smaller

- **Φ-Modulation (Internal Modulation Source)**

- Deviation angle: 0 to 160 rad.
or (40 MHz/ΦM Rate) rad., whichever smaller
- Modulation Frequency: 0.1 Hz to 40 MHz,
or (40 MHz/ΦM Deviation), whichever smaller

- **Pulse Modulation (Internal Modulation Source)**

- Modulation Frequency: 0.1 Hz to 10 MHz
- Modulation Period: 10 ns to 20 s

- **Additional Analog Modulation Input [Opt. 050/080]**

Adding additional analog modulation input options (Opt. 050/080) extends to two internal modulation sources (AM/FM/ΦM) and one external modulation source supporting simultaneous two-signal modulation. This is used when superimposing tone squelch signals.

- AM + FM
- AM + ΦM
- Internal 1 + Internal 2
- Internal + External

* FM + ΦM does not support.

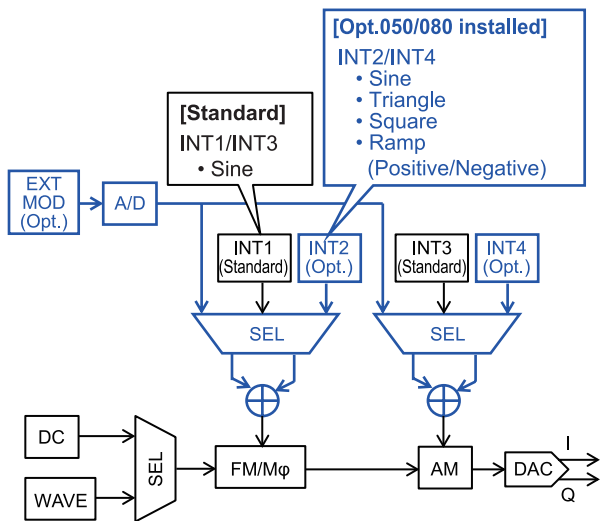

USB Power Sensors [Sold separately]

Up to two USB power sensors can be connected to the MG3740A to display the measurement results on the MG3740A screen.

- **USB Power Sensor**

Model	Frequency Range	Dynamic Range
MA24104A*	600 MHz to 4 GHz	+3 to +51.76 dBm
MA24105A	350 MHz to 4 GHz	+3 to +51.76 dBm
MA24106A	50 MHz to 6 GHz	-40 to +23 dBm
MA24108A	10 MHz to 8 GHz	-40 to +20 dBm
MA24118A	10 MHz to 18 GHz	-40 to +20 dBm
MA24126A	10 MHz to 26 GHz	-40 to +20 dBm

*: MA24104A has been discontinued. Replacement model is MA24105A.

Level Offset: -100 to +100 dB
Average: 1 to 2048
Unit: dBm, W
COM Port: 2 to 8

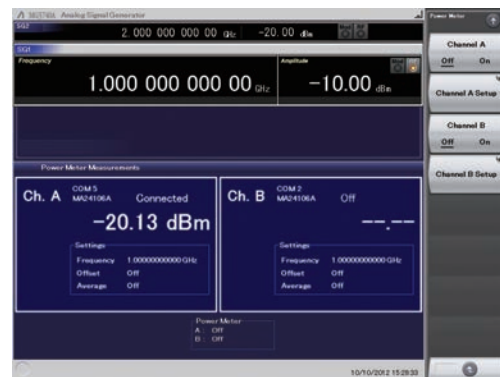
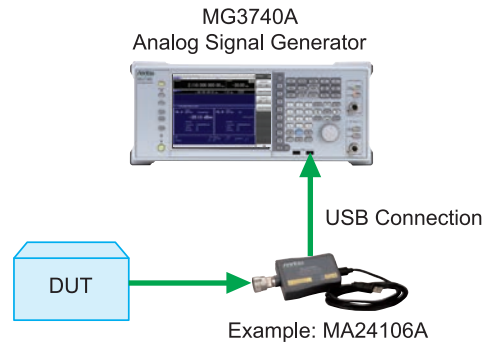

Power Meter Measurement Screen

Operability

Easy Touch-panel Operation

Simply touching parts of the screen display with a finger fetches related function keys and numeric inputs, offering a fast and easy way of navigating through multilayer menus.

Frequency Setting

Level Setting

AM/FM/ΦM/Pulse Function

Modulation	State	Source	Rate	Phase
AM	On	0.5%	Set	1.0000 MHz
FM	Off	0.5%	Set	400.0 Hz
ΦM	Off	0.5%	Set	400.0 Hz
Pulse	Off	0.5%	Set	400.0 Hz

Power Meter Function

Ch. A: Connected, -20.13 dBm

Ch. B: Off

BER Function [Opt. 021]

Measuring: Bit Error

Sync Loss Count: 0

Error Rate: 1.000E-002 (1%)

Error Count: 38974 / 3897438

Signal Flowcharts

The Hardware Block Chart provides an intuitive at-a-glance understanding of the settings and signals for each block (Analog Mod, Pulse Mod, Local, etc.)

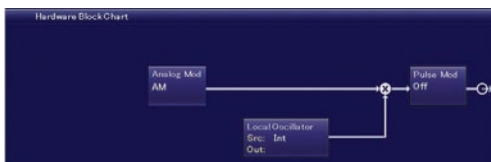

Hardware Block Chart Screen

Frequency Channel Table

Sometimes frequencies need setting by Channel No. The built-in frequency channel table where frequencies are set by channel number is ideal for this application. Once set and saved, these pre-settings can be read whenever needed.

Channel Table Setting

- Group: 1 to 19
- Start Channel: 0 to 20000
- End Channel: (Start Channel) to 20000
- Start Frequency
- Channel Spacing

Connection with External Equipment

Remote Control Interfaces

The MG3740A has GPIB, Ethernet and USB interfaces as standard, supporting the following functions:

- Control all functions, except power switch
- Read all status conditions and settings
- Interrupts and serial polls

While in the Local status, the interface is determined automatically by the communication start command from the external controller (PC). To change the interface, put the MG3740A into the Local status again by pressing the Local key on the front panel and then send a command via the desired interface.

- **GPIB: Conforms to IEEE488.1/IEEE488.2 standards**
SH1, AH1, T6, L4, SR1, RL1, PP0, DC1, DT0, C0, E2
- **Ethernet: Conforms to VXI-11 protocol using TCP/IP**
Control programs
SH1, AH1, T6, L4, SR1, RL1, PP0, DC1, DT0, C0
- **USB: Conforms to USBTMC-USB488 protocols**
SH1, AH1, T6, L4, SR1, RL1, PP0, DC1, DT0, C0n

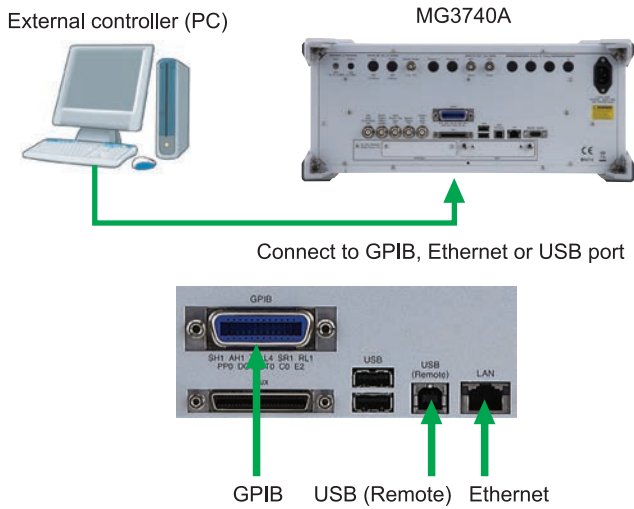

USB Connections

The two type-A USB2.0 connectors on the front and rear panels support keyboard, mouse and USB memory connections. Supported USB power sensors can be connected too.

To remotely control the MG3740A, either select the SCPI mode command format defined by the SCPI Consortium, or select backwards compatible modes supporting earlier MG3700A, MS269xA, MS2830A, and MG364xA commands

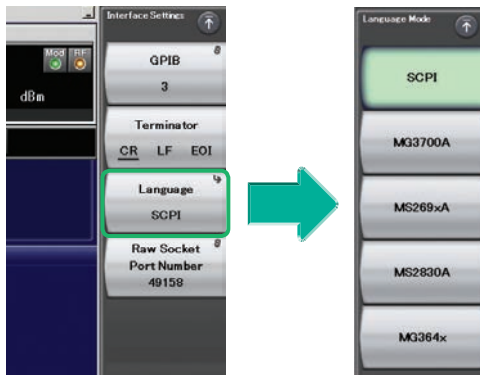

Command Format Setting Example

Analog Radio Rx Characteristics Tests

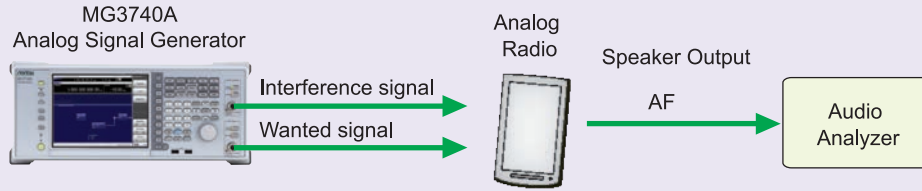

Setup for analog radio Rx characteristics tests

The MG3740A outputs RF signals for radio operation verification tests and evaluation of Rx characteristics, when the radio AF output can be measured with an external audio analyzer.



• High-Purity Signal Source for Testing Analog Radio

Supports SSB Phase Noise Performance -140 dBc/Hz nom. (@100 MHz)

Phase noise performance affects measurement results at narrow bandwidths of several kHz. In particular, high phase-noise performance is required for interference waveforms.

The excellent SSB phase noise performance supports narrowband radio Rx sensitivity suppression tests.

- < -140 dBc/Hz (nom.) @100 MHz, 20-kHz offset, CW
- < -131 dBc/Hz (typ.) @1 GHz, 20-kHz offset, CW
- < -125 dBc/Hz (typ.) @2 GHz, 20-kHz offset, CW

The excellent level accuracy over a wide output level range supports accurate Rx sensitivity tests.

Amplitude setting range: -110 to $+17$ dBm (Standard)
 -144 to $+17$ dBm (with opt. 042/072)

Absolute level accuracy: ± 0.5 dB*1

Linearity 1: ± 0.2 dB (typ)*2

*1: 400 MHz to 3 GHz, -110 to $+10$ dBm

*2: 50 MHz to 3 GHz, -110 to -1 dBm

• Supports Maximum Two RF Outputs

The dual RF outputs of the all-in-one MG3740A help cut infrastructure costs by eliminating the need for two signal sources when outputting wanted + interference waves for RX characteristics tests, and evaluating intermodulation characteristics, etc.

Additionally, there is no need for troublesome settings at each of two separate signal generators helping cut operation time and costs using the frequency/level synchronization function.

• AM/FM/ Φ M/Pulse Function (Standard)

Supports built-in analog modulation (AM/FM/ Φ M) functions and pulse modulation (PM) functions.

Adding additional analog modulation input options (Opt. 050/080) supports modulation by external signal input. This is used when superimposing tone squelch signals.

- AM + FM
- AM + Φ M
- Internal 1 + Internal 2
- Internal + External

* FM + Φ M does not support.

Analog Radio Main Rx Characteristics Evaluation Items

Test Items	Key MG3740A Features	
Sensitivity	✓	Wide level range, High level accuracy, Internal modulation function (standard)
Passing Bandwidth, Attenuation	✓	High level accuracy, Frequency offset setting function
AF Level	✓	Internal modulation function (standard)
Demodulation Frequency Characteristics	✓	Internal modulation function (standard)
Demodulation Distortion	✓	Internal modulation function (standard)
Demodulation S/N	✓	Internal modulation function (standard), External modulation function (Option)
Spurious Response	✓	High level accuracy, Internal modulation function (standard)
Sensitivity Suppression Effect	✓	Dual RF, Low SSB Phase Noise *All-in-one evaluation without requiring two separate signal sources.
Intermodulation Characteristics	✓	Dual RF, Low SSB Phase Noise *Two units of MG3740A support evaluation without requiring three separate signal sources.

Reference Signal Generator for Evaluating Characteristics of Amplifiers, Mixers, etc.

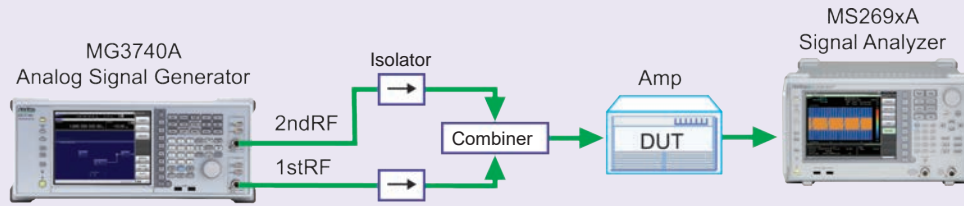

Setup for evaluating intermodulation characteristics of amplifier

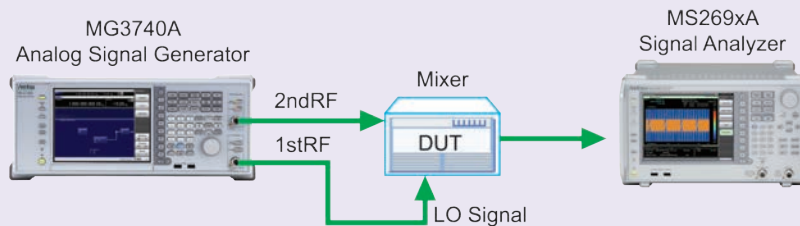

Setup for evaluating distortion characteristics of Mixer

The dual RF outputs of the MG3740A are ideal for evaluating intermodulation (IM3) characteristics of amplifiers, etc., as well as for use as RF/LO signal sources for testing mixers, eliminating the need for two separate signal generators. The high-performance MS269xA Signal Analyzer series is recommended for intermodulation and harmonic wave distortion measurements.

Dual RF outputs



Cuts Costs

Cuts Workload

No External Amp



Stable Level Accuracy

Cuts Risk of Damage to DUT

• Supports Maximum Two RF Outputs

Usually, two general signal generators are required to output two continuous waveforms when evaluating the intermodulation characteristics of amplifiers, etc., or for use as RF/LO signal sources at mixer tests. A maximum of two RF outputs (1stRF/2ndRF) can be installed in the MG3740A and the product lineup includes models with different 1stRF and 2ndRF frequencies. Different frequencies and levels can be set at the two signal outputs and the frequency/level synchronization function cuts the setting workload too.

USB Power Sensor



Efficient Equipment Investment

• USB Power Sensor

Up to two USB power sensors (separately sold) can be connected to the MG3740A. USB connectors to display the measurement results on the MG3740A screen.

Model	Frequency Range	Dynamic Range
MA24104A*	600 MHz to 4 GHz	+3 to +51.76 dBm
MA24105A	350 MHz to 4 GHz	+3 to +51.76 dBm
MA24106A	50 MHz to 6 GHz	-40 to +23 dBm
MA24108A	10 MHz to 8 GHz	-40 to +20 dBm
MA24118A	10 MHz to 18 GHz	-40 to +20 dBm
MA24126A	10 MHz to 26 GHz	-40 to +20 dBm

*: MA24104A has been discontinued. Replacement model is MA24105A.

• High-power Output Option (Opt. 041/071) Supports CW Levels of +23 dBm

In general, an external amp is required when the output of a signal generator is insufficient, such as covering the measurement system transmission path loss and inputting high-level modulation signals for amp distortion characteristics tests. Since the output of an external amp cannot be assured, it must be checked with a power meter each time the frequency and level are changed. Moreover, when using an external amp, sometimes the DUT may be damaged by mishandling errors. The MG3740A high-power output supports signals required for measuring path loss. In addition, stable measurement is assured when used within the guaranteed setting range. And the risk of mistakenly damaging the DUT is reduced, even at the output limit.

Expansion to Digital Modulation Signal Generator

The MG3740A Analog Signal Generator can be expanded to add digital modulation generation functions, supporting evaluation of digital public safety radio systems. All-in-one support for both analog and digital tests maximizes equipment investment efficiency.

Digital Modulation [Opt. 020]

Adding the digital modulation option [Opt. 020] supports generation of digital modulation signals by outputting narrowband digital modulation signals.

- Digital Modulation Performance
- RF Modulation Bandwidth : 2 MHz
 - Sampling Rate : 20 kHz to 8 MHz

Dual Waveform Memory: Four Waveform Outputs Max.

In the standard configuration, one RF (1stRF or 2ndRF) has one waveform memory. However, adding the baseband signal combine option (Opt. 048/078) upgrades to two memories for one RF. In other words, models with two RFs (1stRF and 2ndRF) installed can have a maximum of four waveform memories. Two waveform patterns can be set easily on-screen for one RF, each with different frequency offset, level offset and delay time settings to output a combined baseband RF signal. With this setup, one MG3740A supports the following test environment — a setup that previously required two signal generators:

- Wanted Signal + Interference Signal
- Wanted Signal + Delayed Signal

Waveform Generation Software (Separate license)

The IQproducer system provides an easy-to-use GUI for setting parameters according to each communications method. The parameter setting results file can be saved as a file for easy recall later.

* For detail, refer to the IQproducer catalog.

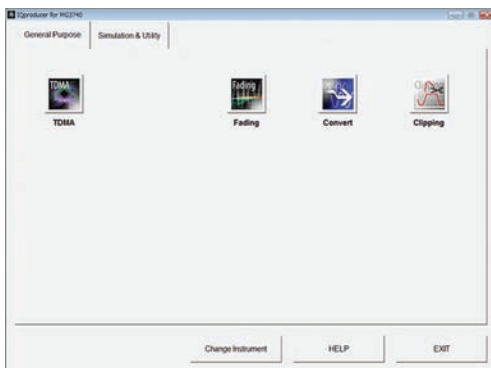

IQproducer Main Screen

[MG3740A Option IQproducer]

- MX370102A TDMA IQproducer
Sets required parameters for TDMA waveform patterns and generates various waveform patterns.
- MX370107A Fading IQproducer
Performs IQ channel fading processing, correlation matrix calculation, AWGN combination.

BER Test Function [Opt. 021]

This option installs a BER measurement function for measuring error rates between 100 bps and 40 Mbps using the DUT demodulated Data/Clock/Enable signals. The results are displayed on the MG3740A screen.

- **Input Bit Rate: 100 bps to 40 Mbps**
- **Input Signal: Data, Clock, Enable**
(Polarity reversal supported)
- **Input Level: TTL**
- **Input Connector: BNC-J**
- **Measured Patterns:**
PN9/11/15/20/23, ALL1, ALL0, Alternate (0101...), User Data, PN9fix/11fix/15fix/20fix/23fix
- **Count Mode**
Data: Measures until specified Data count
Error: Measures until specified Error count
- **Measurable Bit Count: $\leq 2^{32} - 1$ (4,294,967,295 bits)**
- **Measurement Mode**
Single: Measures specified measurement bit count once
Continuous: Repeats Single measurement
Endless: Continues measurement to upper limit of measurement bits

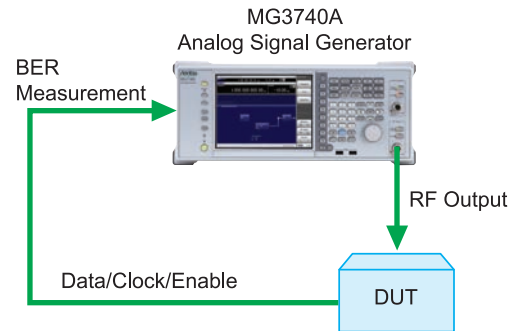

The BER can be measured using the DUT-demodulated Data/Clock/Enable.

• BER Measurement Upper Limit

The table below shows one example of a BER measurement that indicates SyncLoss. Actual results depend on the specific communication systems and data rate, and will not necessarily match the measurement values below.

Error Rate	PN9	PN11	PN15	PN20	PN23
6.0%	—	—	—	—	—
5.0%	ok	—	—	—	—
4.0%	ok	ok	—	—	—
3.0%	ok	ok	ok	—	—
2.5%	ok	ok	ok	—	—
2.0%	ok	ok	ok	ok	ok
1.0%	ok	ok	ok	ok	ok

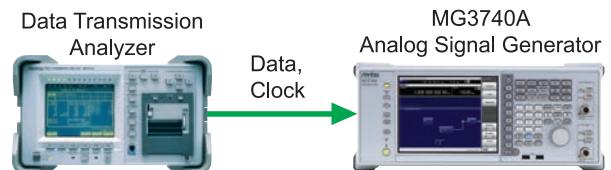

Key Differences from MG3710A Vector Signal Generator

Installing the Digital Modulation Option (Opt. 020) in the MG3740A Analog Signal Generator adds the functions of a digital modulation signal generator. The key differences in the main functions compared to the conventional MG3710A Vector Signal Generator are listed below.

Key Functional Differences between MG3740A Analog Signal Generator and MG3710A Vector Signal Generator

	MG3740A Analog Signal Generator	MG3710A*1 Vector Signal Generator	Remarks
Frequency Range	100 kHz to 2.7 GHz (Opt. 032/062) 100 kHz to 4.0 GHz (Opt. 034/064) 100 kHz to 6.0 GHz (Opt. 036/066)	100 kHz to 2.7 GHz (Opt. 032/062) 100 kHz to 4.0 GHz (Opt. 034/064) 100 kHz to 6.0 GHz (Opt. 036/066)	Supports two signal generators (1stRF/2ndRF output) in one unit
Analog Modulation Internal Source	[Standard]	[Standard]	AM, FM/ΦM Each one internal source
Additional Analog Modulation Input	[Opt. 050/080]	[Opt. 050/080]	Extends to one external input, two internal source (AM, FM/ΦM)
Digital Modulation	[Opt. 020] Digital modulation performance - RF modulation bandwidth: 2 MHz - Sampling rate: 20 kHz to 8 MHz	[Standard] Digital modulation performance - RF modulation bandwidth: 160 MHz*/120 MHz - Sampling rate: 20 kHz to 200 MHz*/160 MHz	
Pre-installed Waveform Patterns	No	Yes	LTE FDD/TDD (E-TM1.1 to E-TM3.3) W-CDMA/HSDPA, GSM/EDGE, CDMA2000 1X/1xEV-DO, WLAN (IEEE802.11a/11b/11g), etc.
Waveform pattern/IQproducer	TDMA IQproducer Fading IQproducer	Listed below	Listed below
ARB Memory Upgrade (per RF)	[Opt. 045/075] Max. 256 Msamples	[Opt. 046/076] Max. 1024 Msamples	Standard: 64 Msamples
Combination of Baseband Signal	[Opt. 048/078]	[Opt. 048/078]	
AWGN Generator	No	[Opt. 049/079]	
Analog IQ Input/Output	No	[Opt. 018]	
Universal Input/Output	[Opt. 017] - Sweep Output (1stRF) - AUX-BNC conversion adapter	[Opt. 017] - Baseband Reference Clock Input/Output - Sweep Output (1stRF) - Local Signal Input/Output - AUX-BNC conversion adapter	
BER Measurement Function	[Opt. 021]	[Opt. 021]	

*1: The MG3710A Vector Signal Generator is recommended for many purposes.
For detail, refer to the MG3710A product brochure.

*2: Only when using MX370111A WLAN IQproducer and MX370111A-002 802.11ac (160 MHz) option.

• Waveform Pattern Support Systems

Main frame support Waveform Pattern

Waveform pattern Support Systems	MG3740A (with Opt. 020)	MG3710A
MX370073A DFS Radar Pattern	—	✓
MX370075A DFS (ETSI) Waveform Pattern	—	✓

For detail, refer to the MX3700xxA Waveform pattern product brochure.

• IQproducer Support Systems

Main frame support IQproducer

IQproducer Support Systems	MG3740A (with Opt. 020)	MG3710A
Standard Accessories		
W-CDMA IQproducer	—	✓
AWGN IQproducer	—	✓
Options		
MX370101A HSDPA/HSUPA IQproducer	—	✓
MX370102A TDMA IQproducer	✓	✓
MX370103A CDMA2000 1xEV-DO IQproducer	—	✓
MX370104A Multi-carrier IQproducer	—	✓
MX370105A Mobile WiMAX IQproducer	—	✓
MX370106A DVB-T/H IQproducer	—	✓
MX370107A Fading IQproducer	✓	✓
MX370108A LTE IQproducer	—	✓
MX370108A-001 LTE-Advanced FDD Option	—	✓
MX370110A LTE TDD IQproducer	—	✓
MX370110A-001 LTE-Advanced TDD Option	—	✓
MX370111A WLAN IQproducer	—	✓
MX370111A-002 802.11ac (160 MHz) Option	—	✓
MX370112A TD-SCDMA IQproducer	—	✓

For detail, refer to the MX3701xxA IQproducer product brochure.

Recommended Configuration

Excellent Expandability Supports both Analog and Narrowband Digital Modulation

The MG3740A can be tailored to various applications, ranging from evaluation of analog modulation radio systems to narrowband digital modulation radio systems by adding cost-effective options.

Application Examples and Options

Option Configuration		Main Applications		
Model	Name	Analog Modulation Radio Systems	Analog/Digital Modulation Radio Systems	Analog/Digital Modulation Radio Systems and CW Interference Signal (2RF)
MG3740A	Analog Signal Generator	✓	✓	✓
MG3740A-032	1stRF 100 kHz to 2.7 GHz	✓	✓	✓
MG3740A-042/142	Low Power Extension for 1stRF/Retrofit	✓	✓	✓
MG3740A-043/143	Reverse Power Protection for 1stRF / Retrofit	✓	✓	✓
MG3740A-050/150	Additional Analog Modulation Input for 1stRF/Retrofit	✓	✓	✓
MG3740A-020/120	Digital Modulation/Retrofit		✓	✓
MG3740A-021/121	BER Test Function/Retrofit		✓	✓
MG3740A-062/162	2ndRF 100 kHz to 2.7 GHz/Retrofit			✓
MG3740A-073/173	Reverse Power Protection for 2ndRF/Retrofit			✓
MX370102A	TDMA IQproducer		✓	✓

Options

Hardware (Common)

MG3740A-001 Rubidium Reference Oscillator

MG3740A-101 Rubidium Reference Oscillator Retrofit

Installs 10 MHz reference crystal oscillator with excellent frequency stability startup characteristics of $\pm 1 \times 10^{-9}$ at 7.5 minutes after power-on.

Aging Rate: $\pm 1 \times 10^{-10}$ /month

Temperature stability: $\pm 2 \times 10^{-9}$ (5° to 45°C)

Start-up characteristics*: $\pm 1 \times 10^{-9}$ (7.5 minutes after power-on)

*: at 23°C, compared to frequency after 24 h warm-up

MG3740A-002 High Stability Reference Oscillator

MG3740A-102 High Stability Reference Oscillator Retrofit

Installs 10 MHz reference oscillator with better frequency stability as follows:

Aging Rate: $\pm 1 \times 10^{-7}$ /year, $\pm 1 \times 10^{-8}$ /day

Temperature stability: $\pm 2 \times 10^{-8}$ (5° to 45°C)

Start-up characteristics*: $\pm 5 \times 10^{-7}$ (2 minutes after power-on)

$\pm 5 \times 10^{-8}$ (5 minutes after power-on)

*: at 23°C, compared to frequency after 24 h warm-up

MG3740A-011 2ndary HDD

MG3740A-111 2ndary HDD Retrofit

User installable/removable HDD

MG3740A-017 Universal Input/Output

MG3740A-117 Universal Input/Output Retrofit

Installs sweep signal output connector on rear panel of main frame. Outputs Sweep Output signal synchronized with sweep. (only supports SG1)

*: Also provides J1539A AUX Conversion Adapter for Opt. 017/117 to use rear-panel AUX connector

MG3740A-020 Digital Modulation

MG3740A-120 Digital Modulation Retrofit

Adding the digital modulation function supports generation of digital modulation signals by outputting narrowband digital modulation signals.

Digital Modulation Performance

- RF Modulation Bandwidth : 2 MHz

- Sampling Rate : 20 kHz to 8 MHz

MG3740A-021 BER Test Function

MG3740A-121 BER Test Function Retrofit

Installs BER measurement function

*: Also provides J1539A AUX Conversion Adapter for Opt. 021/121 to use rear-panel AUX connector

MG3740A-181 CPU/Windows7 Upgrade Retrofit

This option is for MG3740A units ordered until May 2018. The OS in these MG3740A units is either Windows XP or Windows 7 (Professional) if the Opt. 029 (sales discontinued) is installed.

This option upgrades the currently installed standard CPU and OS of these target units to a faster CPU and the Windows 7 (WES7) OS. The faster CPU shortens the time required to generate waveform patterns using IQproducer installed in the MG3740A.

*: Due to license restrictions, this option cannot be installed in MG3740A units with the Opt. 313 Removable HDD (sales discontinued) installed.

Hardware (For 1stRF)

MG3740A-032 1stRF 100 kHz to 2.7 GHz

MG3740A-034 1stRF 100 kHz to 4 GHz

MG3740A-036 1stRF 100 kHz to 6 GHz

Selects 1stRF frequency range

The frequency range cannot be changed after installation.

MG3740A-041 High Power Extension for 1stRF

MG3740A-141 High Power Extension for 1stRF Retrofit

Extends signal output setting range upper limit

Opt. 041/141 installed and Opt. 043/143 not installed

Level setting range: Hi limit +30 dBm (Standard +17 dBm)

Opt. 041/141 not installed and Opt. 043/143 not installed

Level setting range: Hi limit +25 dBm (Standard +17 dBm)

MG3740A-042 Low Power Extension for 1stRF

MG3740A-142 Low Power Extension for 1stRF Retrofit

Extends signal output setting range lower limit

Level setting range: Lo limit -144 dBm (Standard -110 dBm)

MG3740A-043 Reverse Power Protection for 1stRF

MG3740A-143 Reverse Power Protection for 1stRF Retrofit

Protects signal output connector against reverse input power (Standard: 2 W nom.)

Max reverse input: 20 W (nom.) (1 MHz < f ≤ 2 GHz)

10 W (nom.) (2 GHz < f ≤ 6 GHz)

MG3740A-045 ARB Memory Upgrade 256 Msample for 1stRF

MG3740A-145 ARB Memory Upgrade 256 Msample for 1stRF Retrofit

Upgrades ARB size to 256 Msamples (1 GB)

(standard is 64 Msamples/256 MB)

With Opt. 048/148 not installed, installs 1 × 256 Msamples

With Opt. 048/148 installed, installs 2 × 256 Msamples

*: Requires MG3740A-020/120.

MG3740A-048 Combination of Baseband Signal for 1stRF

MG3740A-148 Combination of Baseband Signal for 1stRF Retrofit

Two internal waveform memories. Selects two waveform patterns per one RF output for setting mutual frequency offset, level offset, delay time, etc., to output 2 signals from 1 RF connector

*: Requires MG3740A-020/120.

MG3740A-050 Additional Analog Modulation Input for 1stRF

MG3740A-150 Additional Analog Modulation Input for 1stRF Retrofit

Adds additional analog modulation inputs function for 1stRF.

Extends to two internal modulation sources (AM/FM/ΦM), and one external modulation source supporting simultaneous two-signal modulation.

Installs external signal input connector on rear panel of main unit.

Hardware (For 2ndRF)

MG3740A-062 2ndRF 100 kHz to 2.7 GHz
MG3740A-064 2ndRF 100 kHz to 4 GHz
MG3740A-066 2ndRF 100 kHz to 6 GHz
MG3740A-162 2ndRF 100 kHz to 2.7 GHz Retrofit
MG3740A-164 2ndRF 100 kHz to 4 GHz Retrofit
MG3740A-166 2ndRF 100 kHz to 6 GHz Retrofit

Selects 2ndRF frequency range
The frequency range cannot be changed after installation.
Can only be retrofitted when 2ndRF not installed.

MG3740A-071 High Power Extension for 2ndRF
MG3740A-171 High Power Extension for 2ndRF Retrofit
Extends signal output setting range upper limit

Opt. 071/171 installed and Opt. 073/173 not installed
Level setting range: Hi limit +30 dBm (Standard +17 dBm)
Opt. 071/171 not installed and Opt. 073/173 not installed
Level setting range: Hi limit +25 dBm (Standard +17 dBm)

MG3740A-072 Low Power Extension for 2ndRF
MG3740A-172 Low Power Extension for 2ndRF Retrofit
Extends signal output setting range lower limit

Level setting range: Lo limit -144 dBm (Standard -110 dBm)

MG3740A-073 Reverse Power Protection for 2ndRF
MG3740A-173 Reverse Power Protection for 2ndRF Retrofit
Protects signal output connector against reverse input power
(Standard: 2 W nom.)

Max reverse input: 20 W (nom.) (1 MHz < f ≤ 2 GHz),
10 W (nom.) (2 GHz < f ≤ 6 GHz)

MG3740A-075 ARB Memory Upgrade 256 Msample for 2ndRF
MG3740A-175 ARB Memory Upgrade 256 Msample for 2ndRF
Retrofit

Upgrades ARB size to 256 Msamples (1 GB)
(standard is 64 Msamples/256 MB)

With Opt. 078/178 not installed, installs 1 × 256 Msamples
With Opt. 078/178 installed, installs 2 × 256 Msamples

*: Requires MG3740A-020/120.

MG3740A-078 Combination of Baseband Signal for 2ndRF
MG3740A-178 Combination of Baseband Signal for 2ndRF
Retrofit

Two internal waveform memories. Selects two waveform patterns per one RF output for setting mutual frequency offset, level offset, delay time, etc., to output 2 signals from 1 RF connector

*: Requires MG3740A-020/120.

MG3740A-080 Additional Analog Modulation Input for 2ndRF
MG3740A-180 Additional Analog Modulation Input for 2ndRF Retrofit

Adds additional analog modulation inputs function for 2ndRF. Extends to two internal modulation sources (AM/FM/ΦM), and one external modulation source supporting simultaneous two-signal modulation.

Installs external signal input connector on rear panel of main unit.

Software: IQproducer License

IQproducer is PC application software for generating waveform patterns. The parameters are set using IQproducer and the waveform pattern is created to output the signal by selection at the MG3740A. This one software application includes all the following systems.

Since it runs on any PC, the supported functions and parameter range can be verified before purchase.

When outputting a waveform pattern from the MG3740A, no signal is output unless a license for that system is installed in the main frame.

*: Requires MG3740A-020/120.

* Refer to the "IQproducer catalog" for details.

Model: MX370102A

Name: TDMA IQproducer

Sets required parameters for TDMA waveform patterns and generates various waveform patterns. Setting parameters include Modulation, Frame, Slot, Data, Filter, etc. Supports wide application range including public wireless.

Model: MX370107A

Name: Fading IQproducer

Performs IQ channel fading processing, correlation matrix calculation, AWGN combination. Input data file created by selecting waveform pattern file created with other IQproducer software, and IQ data (ASCII) created with other general-purpose simulation tools.

Easy-to-use Panel

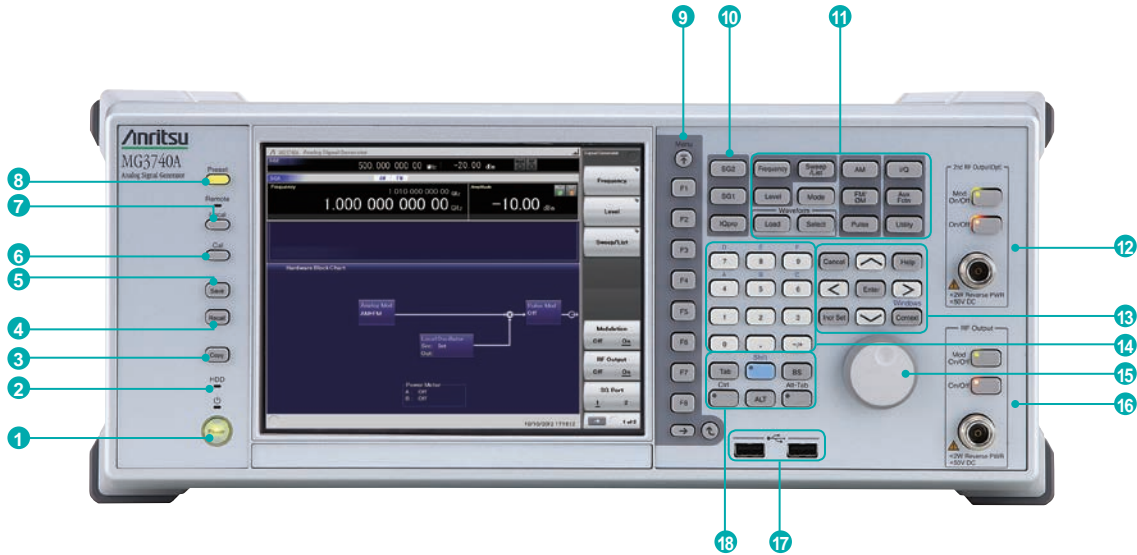

1 Power Switch

Switches between standby status in which AC power is supplied, and operating power-on status. At standby the key lamp is orange; at power-on it is green. To supply power press the switch for 2 seconds or more.

2 HDD Lamp

Lit when internal hard disk being accessed.

3 Copy Key

Copies screen display to file.

4 Recall Key

Displays menu for recalling parameter files.

5 Save Key

Displays menu for saving parameter files.

6 Cal Key

Displays menu for performing calibration.

7 Local Key/Remote Lamp

Local Key: Return remote control via GPIB, Ethernet, USB (B) to local control and enables panel setting.

Remote Lamp: Lit while MG3740A under remote control.

8 Preset Key

Displays Preset menu to initialize parameter settings.

9 Function Keys

Select and execute functions displayed at right edge of display. Displayed functions menus are multi-level with page hierarchy.

10 SG1/SG2/IQpro Keys

SG1: Switches setting target to SG1

SG2: Switches setting target to SG2

IQpro: Starts IQproducer on main frame. IQproducer may not start running for a few seconds to minutes after pressing this key.

11 Main Function Keys

Displays menus for setting and executing main functions: [Frequency], [Level], [Sweep/List], [Mode], [AM], [FM/ΦM], [Pulse], [I/Q], [Load], [Select], [AUX Fctn], [Utility]

12 2ndRF Output [Opt. 062/064/066]

Mod On/Off: Switched 1stRF/2ndRF modulation On/Off. Lamp lit during modulation.

On/Off: Switches RF output On/Off.

13 Arrow/Enter/Cancel/Help/Incr Set/Context/Windows Keys

Help: Pressing function key after Help key displays help for pressed function key

Incr Set: Sets increment/decrement steps for each parameter

Context: Performs same operation and right mouse click

Windows: Performs same operation as Windows key

14 Ten Key Pad

Input numeric values for each parameter setting screen.

15 Rotary Knob

Selects and sets displayed items.

16 RF Output [Opt. 032/034/036]

17 USB Connector (Type A)

18 Tab/Alt/BS/Ctrl/Shift/Alt-Tab Key

Shift key: Executes panel operation indicated by blue characters. Press Shift key and then required key.

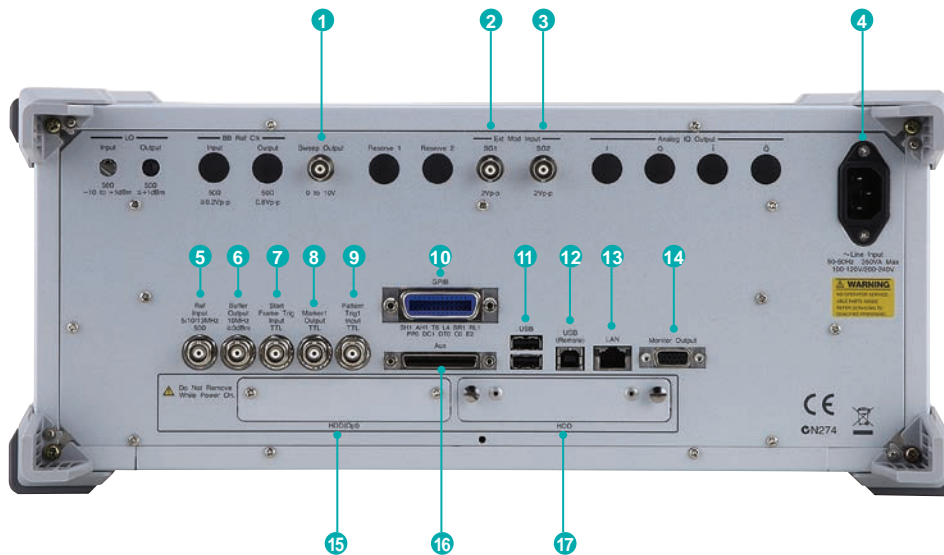

1 Sweep Output

Connector for outputting either 10 V Sweep Signal synchronized with Sweep or Sweep Status signal. Requires Opt. 017.

2 Ext Mod Input SG1

Option connector for inputting external signal for additional analog modulation input for the SG1. Requires Opt. 050.

3 Ext Mod Input SG2

Option connector for inputting external signal for additional analog modulation input for the SG2. Requires Opt. 080.

4 AC Inlet

5 REF Input

Connector for inputting external reference frequency signal (5/10/13 MHz).

6 Buffer Output

Connector for outputting built-in reference frequency signal (10 MHz).

7 Start Frame TRIG Input

Connector (pulled up internally) for inputting external trigger signal.

8 Marker 1 Output

Connector for outputting Marker 1 signal. (Marker 2/3 output from AUX connector. Requires Opt. 020 and J1539A AUX Conversion Adapter.)

9 Pattern TRIG 1 Input

Connector (pulled up internally) for inputting external trigger signal.

10 GPIB

Connector used for remote control via GPIB.

11 USB Connector (Type A)

Connector for USB memory, keyboard, mouse, etc.

12 USB Connector (Type B)

Connector used for remote control via USB.

13 LAN

Connector for personal computer and network.

14 Monitor Output

RGB connector for external display.

15 HDD (Opt)

Slot for hard disk option. Requires Opt. 011.

16 AUX

Connector for following I/O signals.

Requires J1539A AUX Conversion Adapter.

- BER Measurement Signal (Input): Data, CLK, Enable
- Marker Signal (Output): Marker 2, Marker 3
- Pulse Signal for external Pulse Modulation (Input): Pulse Mod
- Signal synchronized with Pulse Modulation signal at PM (Output): Pulse Sync, Pulse Video Out
- Trigger signal at timing of internal Baseband Ref Clock based on Start/Frame trigger (Out): Sync Trigger Out

17 HDD

Hard disk slot

Specifications

Refer to the Data Sheet for specification details such as guaranteed setting ranges, etc.

● Frequency Setting Range

- 1stRF
 - MG3740A-032 9 kHz to 2.7 GHz
 - MG3740A-034 9 kHz to 4 GHz
 - MG3740A-036 9 kHz to 6 GHz
- 2ndRF
 - MG3740A-062 9 kHz to 2.7 GHz
 - MG3740A-064 9 kHz to 4 GHz
 - MG3740A-066 9 kHz to 6 GHz

● Switching Speed (List Mode)

- Frequency ≤600 μs
- Level ≤600 μs

● Amplitude Setting Range

Options	Setting Range [dBm]	
	without Reverse Power Protection	with Reverse Power Protection
Standard	-110 to +17	-110 to +17
with High-power Extension	-110 to +30	-110 to +25
with Low-power Extension	-144 to +17	-144 to +17
with High-power Extension and Low-power Extension	-144 to +30	-144 to +25

Level Accuracy is assured at high levels (CW)

Frequency Range	Standard	Opt. 041/071
100 kHz ≤ f < 10 MHz	+5 dBm	+5 dBm
10 MHz ≤ f < 50 MHz	+10 dBm	+10 dBm
50 MHz ≤ f < 400 MHz	+13 dBm	+20 dBm
400 MHz ≤ f ≤ 3 GHz		+23 dBm
3 GHz < f ≤ 4 GHz		+20 dBm
4 GHz < f ≤ 5 GHz		+13 dBm
5 GHz < f ≤ 6 GHz	+11 dBm	+11 dBm

● Absolute Level Accuracy

(at CW, 18° to 28°C, -110 to +5 dBm)

- ±0.5 dB (typ.) (100 kHz ≤ f < 50 MHz)
- ±0.5 dB (50 MHz ≤ f ≤ 3 GHz)
- ±0.7 dB (3 GHz < f ≤ 4 GHz)
- ±0.8 dB (4 GHz < f ≤ 6 GHz)

● Harmonics

<-30 dBc

● Non-Harmonics

Output level ≤+5 dBm, CW, Frequency offset ≥10 kHz

- <-62 dBc (100 kHz ≤ f ≤ 187.5 MHz)
- <-68 dBc (187.5 MHz < f ≤ 750 MHz)
- <-62 dBc (750 MHz < f ≤ 1.5 GHz)
- <-56 dBc (1.5 GHz < f ≤ 3 GHz)
- <-50 dBc (3 GHz < f ≤ 6 GHz)

● Single Sideband Phase Noise (at CW, 20 kHz offset)

- <-140 dBc/Hz (nom.) (100 MHz)
- <-131 dBc/Hz (typ.) (1 GHz)
- <-125 dBc/Hz (typ.) (2 GHz)

● Analog Modulation

- Amplitude Modulation (Internal Modulation Source)
 - Depth: 0 to 100% (Linear)
 - 0 to 10 dB (Log)
 - Modulation Frequency: 0.1 Hz to 50 MHz
- Frequency Modulation (Internal Modulation Source)
 - Deviation: 0 Hz to 40 MHz
 - Modulation Frequency: 0.1 Hz to 40 MHz, or (50-MHz FM Rate), whichever smaller
- Φ-Modulation (Internal Modulation Source)
 - Deviation angle: 0 to 160 rad., or (40 MHz/ΦM Rate) rad., whichever smaller
 - Modulation Frequency: 0.1 Hz to 40 MHz, or (40 MHz/ΦM Deviation), whichever smaller
- Pulse Modulation (Internal Modulation Source)
 - Modulation Frequency: 0.1 Hz to 10 MHz
 - Modulation Period: 10 ns to 20 s

● Digital Modulation Performance [Opt. 020 installed]

- RF Modulation Bandwidth
 - 2 MHz
- ARB Memory Size
 - 64 Msamples (256 MB) [with 1stRF, 2ndRF]
 - 256 Msamples (1 GB) [Opt. 045/075]
- Sampling Rate
 - 20 kHz to 8 MHz
- DAC Resolution
 - 14/15/16 bits
- Dimensions, Weight
 - 177 (H) × 426 (W) × 390 (D) mm
 - ≤13.7 kg (with 1stRF, excluding other option)
- Power Requirements
 - 100 V(ac) to 120 V(ac), 200 V(ac) to 240 V(ac)
 - 50 Hz to 60 Hz

Options Configuration Guide

The following table shows the recommended option combinations.

Type	Opt. No	Retrofit	Name	032	034	036	041	042	043	045	048	050	062	064	066	071	072	073	075	078	080	001	002	011	017	020	021
1stRF	MG3740A-032		1stRF 100 kHz to 2.7 GHz		*1	*1																					
1stRF	MG3740A-034		1stRF 100 kHz to 4 GHz	*1		*1																					
1stRF	MG3740A-036		1stRF 100 kHz to 6 GHz	*1	*1																						
1stRF	MG3740A-041	141	High Power Extension for 1stRF																								
1stRF	MG3740A-042	142	Low Power Extension for 1stRF																								
1stRF	MG3740A-043	143	Reverse Power Protection for 1stRF																								
1stRF	MG3740A-045	145	ARB Memory Upgrade 256 Msample for 1stRF																								*3
1stRF	MG3740A-048	148	Combination of Baseband Signal for 1stRF																								*3
1stRF	MG3740A-050	150	Additional Analog Modulation Input for 1stRF																								
2ndRF	MG3740A-062	162	2ndRF 100 kHz to 2.7 GHz												*2	*2											
2ndRF	MG3740A-064	164	2ndRF 100 kHz to 4 GHz											*2	*2												
2ndRF	MG3740A-066	166	2ndRF 100 kHz to 6 GHz											*2	*2												
2ndRF	MG3740A-071	171	High Power Extension for 2ndRF																								
2ndRF	MG3740A-072	172	Low Power Extension for 2ndRF																								
2ndRF	MG3740A-073	173	Reverse Power Protection for 2ndRF																								
2ndRF	MG3740A-075	175	ARB Memory Upgrade 256 Msample for 2ndRF																								*3
2ndRF	MG3740A-078	178	Combination of Baseband Signal for 2ndRF																								*3
2ndRF	MG3740A-080	180	Additional Analog Modulation Input for 2ndRF																								
Common	MG3740A-001	101	Rubidium Reference Oscillator																								
Common	MG3740A-002	102	High Stability Reference Oscillator																								
Common	MG3740A-011	111	2ndary HDD																								
Common	MG3740A-017	117	Universal Input/Output																								
Common	MG3740A-020	120	Digital Modulation																								
Common	MG3740A-021	121	BER Test Function																								

- *1: Only one of 2.7 GHz, 4 GHz, and 6 GHz options. Install any one 1stRF option. Retrofitting one of these options disables previously installed option.
- *2: Only one of 2.7 GHz, 4 GHz, and 6 GHz options. Retrofitting one of these options disables previously installed option. Install any one 2ndRF option.
Can be retrofitted only when 2ndRF not installed.
- *3: Requires Digital Modulation (Opt. 020/120).

Maximum Waveform Pattern Size and Required Options for Simultaneous Use

1stRF (Opt. 032/034/036)

Combination of Baseband Signal (Opt. 048)	ARB Memory Upgrade 256 Msample (Opt. 045)	
	W/O	With Opt. 045
W/O	64 Msamples x 1 pc	256 Msamples x 1 pc
With Opt. 048*	64 Msamples x 2 pcs 128 Msamples x 1 pc	256 Msamples x 2 pcs 512 Msamples x 1 pc

2ndRF (Opt. 062/064/066)

Combination of Baseband Signal (Opt. 078)	ARB Memory Upgrade 256 Msample (Opt. 075)	
	W/O	With Opt. 075
W/O	64 Msamples x 1 pc	256 Msamples x 1 pc
With Opt. 078*	64 Msamples x 2 pcs 128 Msamples x 1 pc	256 Msamples x 2 pcs 512 Msamples x 1 pc

- *: The Baseband Signal Combine option supports two ARB memories and can either set two different waveform patterns or combine them as one memory to support one large waveform pattern.

Ordering Information

Please specify the model/order number, name and quantity when ordering.

The names listed in the chart below are Order Names. The actual name of the item may differ from the Order Name.

Model/Order No.	Name	Remarks
MG3740A	- Main frame - Analog Signal Generator	
P0031A	- Standard accessories - Power Cord: 1 pc USB Memory Install CD-ROM	USB2.0 Flash Driver, ≥256 MB Operation manual (PDF) and application software (IQproducer)
MG3740A-001 MG3740A-002 MG3740A-011 MG3740A-017 MG3740A-020 MG3740A-021 MG3740A-101 MG3740A-102 MG3740A-111 MG3740A-117 MG3740A-120 MG3740A-121 MG3740A-181	- Options - (Common Parts) Rubidium Reference Oscillator High Stability Reference Oscillator 2ndary HDD Universal Input/Output Digital Modulation BER Test Function Rubidium Reference Oscillator Retrofit High Stability Reference Oscillator Retrofit 2ndary HDD Retrofit Universal Input/Output Retrofit Digital Modulation Retrofit BER Test Function Retrofit CPU/Windows7 Upgrade Retrofit	Select when ordering main frame, aging rate: $\pm 1 \times 10^{-10}$ /month Select when ordering main frame, aging rate: $\pm 1 \times 10^{-7}$ /year Select when ordering main frame, spare HDD for saving user data without Windows OS Select when ordering main frame, Adds BNC connectors for Sweep Output signal (only supports SG1) to rear panel of main frame, includes J1539A AUX Conversion Adapter Select when ordering main frame, Built-in Digital Modulation function. Digital modulation Performance: - RF modulation bandwidth: 2 MHz - Sampling rate: 20 kHz to 8 MHz Select when ordering main frame, Built-in BER measurement, Bit Rate: 100 bps to 40 Mbps J1539A AUX Conversion Adapter required for Data/Clock/Enable signal input Retrofitted to shipped MG3740A Retrofitted to shipped MG3740A Retrofitted to shipped MG3740A Retrofitted to shipped MG3740A Retrofitted to shipped MG3740A Retrofitted to shipped MG3740A Retrofitted to shipped MG3740A Retrofitted to shipped MG3740A This option is for MG3740A units ordered until May 2018. It upgrades the currently installed CPU to a faster CPU and the OS to Windows 7 (WES7). Due to OS license restrictions, this option is not applicable to MG3740A units in which Opt. 313 Removable HDD (sales discontinued) is installed.
MG3740A-032 MG3740A-034 MG3740A-036 MG3740A-041 MG3740A-042 MG3740A-043 MG3740A-045 MG3740A-048 MG3740A-050 MG3740A-141 MG3740A-142 MG3740A-143 MG3740A-145 MG3740A-148 MG3740A-150	(For 1stRF) 1stRF 100 kHz to 2.7 GHz 1stRF 100 kHz to 4 GHz 1stRF 100 kHz to 6 GHz High Power Extension for 1stRF Low Power Extension for 1stRF Reverse Power Protection for 1stRF ARB Memory Upgrade 256 Msample for 1stRF Combination of Baseband Signal for 1stRF Additional Analog Modulation Input for 1stRF High Power Extension for 1stRF Retrofit Low Power Extension for 1stRF Retrofit Reverse Power Protection for 1stRF Retrofit ARB Memory Upgrade 256 Msample for 1stRF Retrofit Combination of Baseband Signal for 1stRF Retrofit Additional Analog Modulation Input for 1stRF Retrofit	Select when ordering main frame, select 1stRF frequency range, frequency cannot be changed after installation Select when ordering main frame, select 1stRF frequency range, frequency cannot be changed after installation Select when ordering main frame, select 1stRF frequency range, frequency cannot be changed after installation Select when ordering main frame, increases upper limit of output signal power setting range Select when ordering main frame, increases lower limit of output signal power setting range Select when ordering main frame, prevents damage caused by reverse input to output connector Select when ordering main frame, expands ARB memory capacity. Requires MG3740A-020. Select when ordering main frame, adds baseband combine function. Requires MG3740A-020. Select when ordering main frame, Adds BNC connector for inputting external signals to rear panel of mainframe. Retrofitted to shipped MG3740A Retrofitted to shipped MG3740A Retrofitted to shipped MG3740A Retrofitted to shipped MG3740A Retrofitted to shipped MG3740A. Requires MG3740A-020/120. Retrofitted to shipped MG3740A. Requires MG3740A-020/120. Retrofitted to shipped MG3740A
MG3740A-062 MG3740A-064 MG3740A-066 MG3740A-071 MG3740A-072 MG3740A-073 MG3740A-075 MG3740A-078 MG3740A-080 MG3740A-162 MG3740A-164 MG3740A-166 MG3740A-171 MG3740A-172 MG3740A-173 MG3740A-175 MG3740A-178 MG3740A-180	(For 2ndRF) 2ndRF 100 kHz to 2.7 GHz 2ndRF 100 kHz to 4 GHz 2ndRF 100 kHz to 6 GHz High Power Extension for 2ndRF Low Power Extension for 2ndRF Reverse Power Protection for 2ndRF ARB Memory Upgrade 256 Msample for 2ndRF Combination of Baseband Signal for 2ndRF Additional Analog Modulation Input for 2ndRF 2ndRF 100 kHz to 2.7 GHz Retrofit 2ndRF 100 kHz to 4 GHz Retrofit 2ndRF 100 kHz to 6 GHz Retrofit High Power Extension for 2ndRF Retrofit Low Power Extension for 2ndRF Retrofit Reverse Power Protection for 2ndRF Retrofit ARB Memory Upgrade 256 Msample for 2ndRF Retrofit Combination of Baseband Signal for 2ndRF Retrofit Additional Analog Modulation Input for 2ndRF Retrofit	Select when ordering main frame, select 2ndRF frequency range, frequency cannot be changed after installation Select when ordering main frame, select 2ndRF frequency range, frequency cannot be changed after installation Select when ordering main frame, select 2ndRF frequency range, frequency cannot be changed after installation Select when ordering main frame, increases upper limit of output signal power setting range Select when ordering main frame, increases lower limit of output signal power setting range Select when ordering main frame, prevents damage caused by reverse input to output connector Select when ordering main frame, expands ARB memory capacity. Requires MG3740A-020. Select when ordering main frame, adds baseband combine function. Requires MG3740A-020. Select when ordering main frame, Adds BNC connector for inputting external signals to rear panel of mainframe. Retrofitted to shipped MG3740A when 2ndRF not installed Retrofitted to shipped MG3740A when 2ndRF not installed Retrofitted to shipped MG3740A when 2ndRF not installed Retrofitted to shipped MG3740A Retrofitted to shipped MG3740A Retrofitted to shipped MG3740A Retrofitted to shipped MG3740A Retrofitted to shipped MG3740A. Requires MG3740A-020/120. Retrofitted to shipped MG3740A. Requires MG3740A-020/120. Retrofitted to shipped MG3740A
MG3740A-ES210 MG3740A-ES310 MG3740A-ES510	- Maintenance service - 2 Years Extended Warranty Service 3 Years Extended Warranty Service 5 Years Extended Warranty Service	

Model/Order No.	Name	Remarks
MX370102A MX370107A	- Softwares - (IQproducer) TDMA IQproducer Fading IQproducer	(License for IQproducer) IQproducer software, license for main frame, manual (PDF) IQproducer software, license for main frame, manual (PDF)
W3580AE W2496AE W2916AE W2995AE	- Optional accessories - MG3710A/MG3740A Operation Manual (Main Unit) MG3710A/MG3740A Operation Manual (IQproducer) MX370102A Operation Manual MX370107A Operation Manual	Booklet, for MG3710A/MG3740A Main Frame (Operation, Remote Control) Booklet, for IQproducer (Operation for Common Parts) Booklet, for TDMA IQproducer Booklet, for Fading IQproducer
J1539A Z1572A MA24105A MA24106A MA24108A MA24118A MA24126A K240B	AUX Conversion Adapter Installation Kit Inline Peak Power Sensor USB Power Sensor Microwave USB Power Sensor Microwave USB Power Sensor Microwave USB Power Sensor Power Divider (K connector)	Converts MG3740A rear-panel AUX connector to BNC connector Required when retrofitting hardware options or installing IQproducer (MX3701xxA) 350 MHz to 4 GHz, Inline type, with USB A to micro-B Cable 50 MHz to 6 GHz, with USB A to mini-B Cable 10 MHz to 8 GHz, with USB A to micro-B Cable 10 MHz to 18 GHz, with USB A to micro-B Cable 10 MHz to 26 GHz, with USB A to micro-B Cable DC to 26.5 GHz, K-J, 50 Ω, 1 Wmax
MA1612A J0576B J0576D J0127A J0127B J0127C J0322A J0322B J0322C J0322D J0004 J1261B J1261D J0008 B0635A B0657A B0636C B0671A Z0975A Z0541A	Four-Port Junction Pad Coaxial Cord, 1.0 m Coaxial Cord, 2.0 m Coaxial Cord, 1.0 m Coaxial Cord, 2.0 m Coaxial Cord, 0.5 m Coaxial Cord, 0.5 m Coaxial Cord, 1.0 m Coaxial Cord, 1.5 m Coaxial Cord, 2.0 m Coaxial Adapter Ethernet Cable (Shield Type) Ethernet Cable (Shield Type) GPIB Cable, 2.0 m Rack Mount Kit Rack Mount Kit (JIS) Carrying Case Front Cover for 1MW4U Keyboard (USB) USB Mouse	5 MHz to 3 GHz, N-J N-P · 5D-2W · N-P N-P · 5D-2W · N-P BNC-P · RG-58A/U · BNC-P BNC-P · RG-58A/U · BNC-P BNC-P · RG-58A/U · BNC-P SMA-P · SMA-P, DC to 18 GHz, 50 Ω SMA-P · SMA-P, DC to 18 GHz, 50 Ω SMA-P · SMA-P, DC to 18 GHz, 50 Ω SMA-P · SMA-P, DC to 18 GHz, 50 Ω N-P · SMA-J Conversion Adapter, DC to 12.4 GHz Straight-through, 3 m Crossover, 3 m EIA JIS Hard Type. With Casters and B0671A Front Cover



J1539A AUX Conversion Adapter



MA24106A USB Power Sensor



B0636C Carrying Case
(Hard type, with casters)



B0671A Front Cover for 1MW4U

Appendix: Compatibility with MG3641A/MG3642A

The MG3740A Analog Signal Generator replaces the older MG3641A/MG3642A Synthesized Signal Generator. The differences in the main functions of the MG3641A/MG3642A and MG3740A are listed in the following table.

Function difference between MG3641A/MG3642A and MG3740A

MG3641A/MG3642A Synthesized Signal Generator	MG3740A Analog Signal Generator
Frequency range MG3641A: 125 kHz to 1040 MHz MG3642A: 125 kHz to 2080 MHz	Frequency range MG3740A-032: 100 kHz to 2.7 GHz MG3740A-034: 100 kHz to 4 GHz MG3740A-036: 100 kHz to 6 GHz
SSB phase noise [1 GHz, 20 kHz Offset] <-130 dBc/Hz	SSB phase noise [1 GHz, 20 kHz Offset] <-131 dBc/Hz (typ.)
Non-harmonics spurious -100 dBc [15 kHz offset]	Non-harmonics spurious -68 dBc (-76 dBc typ.) [187.5 kHz to 750 MHz, 10 kHz offset]
Pulse modulation On/Off ratio >80 dB	Pulse modulation On/Off ratio >70 dB
Level isolation mode (Controls distortion using large isolation between SGs at IM measurement, etc.)	Distortion control by setting optimize S/N function to On (similar effectiveness)
Level safety mode (Controls high-level signal spikes)	No signal spike generation (Uses built-in electronic attenuator)
Level setting units dBm, dBμ (emf), dBμ (term), V (emf), V (term), mV (emf), mV (term), μV (emf), μV (term)	Level setting units dBm, dBμV (emf), dBμV (term)
Reverse polarity by setting negative value for AM/FM modulation rate	No
Memory function (Saves and reads setting conditions)	Uses parameter Save/Recall function
Internal modulation source: Three AF sources	AM, FM/ΦM: each two sources [Standard] One internal AF source [with Opt. 050/080] Supports selection of internal second AF signals and external modulation input signals.
External modulation source: Two external sources	One external source [with Opt. 050/080]
Impedance setting for external pulse modulation input [50Ω, 600Ω, TTL]	No [only TTL]
AF out connector	No
Trigger Function (Triggers pre-registered panel key operation sequence to execute)	No
Marker Frequency Setting (Outputs High (TTL) when actual sweep frequency matches marker frequency)	No
Tracking control using Only mode	No
Frequency sweep: Start/Stop setting Linear: Point number setting Linear: Step size setting Log: 1% fixed multiplier	Compatible No No
Frequency sweep: Center/Span setting Linear: Point number setting Linear: Step size setting	Compatible No
Level sweep: Start/Stop setting Point number setting Step size setting	Compatible No
Level sweep: Center/Span setting Point number setting Step size setting	No No
Memory sweep Start/Stop address setting	No

Typical (typ.): Performance not warranted. Must products meet typical performance.

Nominal (nom.): Values not warranted. Included to facilitate application of product.

Measured (meas): Performance not warranted. Data actually measured by randomly selected measuring instruments.

Trademarks:

- IQproducer™ is a registered trademark of Anritsu Corporation.
- MATLAB® is a registered trademark of The MathWorks, Inc.
- CDMA2000® is a registered trademark of the Telecommunications Industry Association (TIA-USA).
- The *Bluetooth*® mark and logos are owned by Bluetooth SIG, Inc. and are used by Anritsu under license.
- Pentium® is registered trademarks of Intel Corporation or its subsidiaries in the USA and other countries.
- Windows® is a registered trademark of Microsoft Corporation in the USA and other countries.
- WiMAX® is a trademark or registered trademark of WiMAX Forum.
- Other companies, product names and service names are registered trademarks of their respective companies.

● **United States**

Anritsu Company

1155 East Collins Blvd., Suite 100, Richardson,
TX 75081, U.S.A.
Toll Free: 1-800-267-4878
Phone: +1-972-644-1777
Fax: +1-972-671-1877

● **Canada**

Anritsu Electronics Ltd.

700 Silver Seven Road, Suite 120, Kanata,
Ontario K2V 1C3, Canada
Phone: +1-613-591-2003
Fax: +1-613-591-1006

● **Brazil**

Anritsu Eletronica Ltda.

Praça Amadeu Amaral, 27 - 1 Andar
01327-010 - Bela Vista - Sao Paulo - SP
Brazil
Phone: +55-11-3283-2511
Fax: +55-11-3288-6940

● **Mexico**

Anritsu Company, S.A. de C.V.

Bldv Miguel de Cervantes Saavedra #169 Piso 1, Col. Granada
Mexico, Ciudad de Mexico, 11520, MEXICO
Phone: +52-55-4169-7104

● **United Kingdom**

Anritsu EMEA Ltd.

200 Capability Green, Luton, Bedfordshire, LU1 3LU, U.K.
Phone: +44-1582-433200
Fax: +44-1582-731303

● **France**

Anritsu S.A.

12 avenue du Québec, Bâtiment Iris 1- Silic 612,
91140 VILLEBON SUR YVETTE, France
Phone: +33-1-60-92-15-50
Fax: +33-1-64-46-10-65

● **Germany**

Anritsu GmbH

Nemetschek Haus, Konrad-Zuse-Platz 1
81829 München, Germany
Phone: +49-89-442308-0
Fax: +49-89-442308-55

● **Italy**

Anritsu S.r.l.

Via Elio Vittorini 129, 00144 Roma, Italy
Phone: +39-6-509-9711
Fax: +39-6-502-2425

● **Sweden**

Anritsu AB

Isafjordsgatan 32C, 164 40 KISTA, Sweden
Phone: +46-8-534-707-00

● **Finland**

Anritsu AB

Teknobulevardi 3-5, FI-01530 VANTAA, Finland
Phone: +358-20-741-8100
Fax: +358-20-741-8111

● **Denmark**

Anritsu A/S

Torveporten 2, 2500 Valby, Denmark
Phone: +45-7211-2200
Fax: +45-7211-2210

● **Russia**

Anritsu EMEA Ltd.

Representation Office in Russia
Tverskaya str. 16/2, bld. 1, 7th floor.
Moscow, 125009, Russia
Phone: +7-495-363-1694
Fax: +7-495-935-8962

● **Spain**

Anritsu EMEA Ltd.

Representation Office in Spain
Edificio Cuzco IV, Po. de la Castellana, 141, Pta. 5
28046, Madrid, Spain
Phone: +34-915-726-761
Fax: +34-915-726-621

● **United Arab Emirates**

Anritsu EMEA Ltd. Emirates

Dubai Liaison Office

902, Aurora Tower,
P O Box: 500311- Dubai Internet City
Dubai, United Arab Emirates
Phone: +971-4-3758479
Fax: +971-4-4249036

● **India**

Anritsu India Private Limited

6th Floor, Indiqube ETA, No.38/4, Adjacent to EMC2,
Doddanekundi, Outer Ring Road, Bengaluru - 560048, India
Phone: +91-80-4058-1300
Fax: +91-80-4058-1301

● **Singapore**

Anritsu Pte. Ltd.

11 Chang Charn Road, #04-01, Shriro House
Singapore 159640
Phone: +65-6282-2400
Fax: +65-6282-2533

● **P.R. China (Shanghai)**

Anritsu (China) Co., Ltd.

Room 2701-2705, Tower A,
New Caohejing International Business Center
No. 391 Gui Ping Road Shanghai, 200233, P.R. China
Phone: +86-21-6237-0898
Fax: +86-21-6237-0899

● **P.R. China (Hong Kong)**

Anritsu Company Ltd.

Unit 1006-7, 10/F., Greenfield Tower, Concordia Plaza,
No. 1 Science Museum Road, Tsim Sha Tsui East,
Kowloon, Hong Kong, P.R. China
Phone: +852-2301-4980
Fax: +852-2301-3545

● **Japan**

Anritsu Corporation

8-5, Tamura-cho, Atsugi-shi, Kanagawa, 243-0016 Japan
Phone: +81-46-296-6509
Fax: +81-46-225-8352

● **Korea**

Anritsu Corporation, Ltd.

5FL, 235 Pangyooyeok-ro, Bundang-gu, Seongnam-si,
Gyeonggi-do, 13494 Korea
Phone: +82-31-696-7750
Fax: +82-31-696-7751

● **Australia**

Anritsu Pty. Ltd.

Unit 20, 21-35 Ricketts Road,
Mount Waverley, Victoria 3149, Australia
Phone: +61-3-9558-8177
Fax: +61-3-9558-8255

● **Taiwan**

Anritsu Company Inc.

7F, No. 316, Sec. 1, NeiHu Rd., Taipei 114, Taiwan
Phone: +886-2-8751-1816
Fax: +886-2-8751-1817

Please Contact: