

**Anritsu** envision : ensure

# Field Master Pro™ MS2090A

High-Performance RF Spectrum Analyzer

9 kHz to 9/14/20/26.5/32/44/54 GHz



MS2090A FieldMaster Pro  
9 kHz to 14 GHz

# THE SKY'S

Anritsu introduces the Field Master  
performance handheld



FieldMaster Pro™ MS2090A

# THE LIMIT



Pro MS2090A. The world's highest  
and spectrum analyzer.

## **No limits.**

Delivering the highest levels of performance available in a handheld RF spectrum analyzer, the Field Master Pro MS2090A instrument gives field engineers and technicians unparalleled measurement accuracy previously reserved for only benchtop instruments.

## **No gaps.**

The built-in real-time spectrum analyzer (RTSA) provides the ultimate signal analysis and interference capture tool. RTSA spans of 20 MHz (standard) to 100 MHz (optional) provide capability for cellular interference monitoring to full ISM band signal analysis.

## **No misses.**

Integrated and continuous frequency coverage from 9 kHz to 54 GHz provides the ability to view the RF spectrum and measure all transmissions in order to avoid interference. Unparalleled performance meets the latest 5G test challenges while maintaining support for a full range of wireless technologies in use today.



## Overview

The Anritsu Field Master Pro MS2090A high-performance handheld RF spectrum analyzer is the culmination of over 60 years of microwave test and measurement equipment development that leverages the very latest technologies to deliver performance and accuracy previously reserved for only benchtop instruments. With continuous frequency coverage from 9 kHz to 9/14/20/26.5/32/44/54 GHz, the Field Master Pro MS2090A is leading the way for next-generation test equipment designed to meet the unique needs of technologies used in 5G networks (mmWave frequencies, active antenna systems, beamforming, and dynamic physical layer attributes) while maintaining support for the full range of requirements of today's wireless industries (wireless service providers, broadcasting, regulatory authorities, aerospace/defense, satellite systems, and radar).

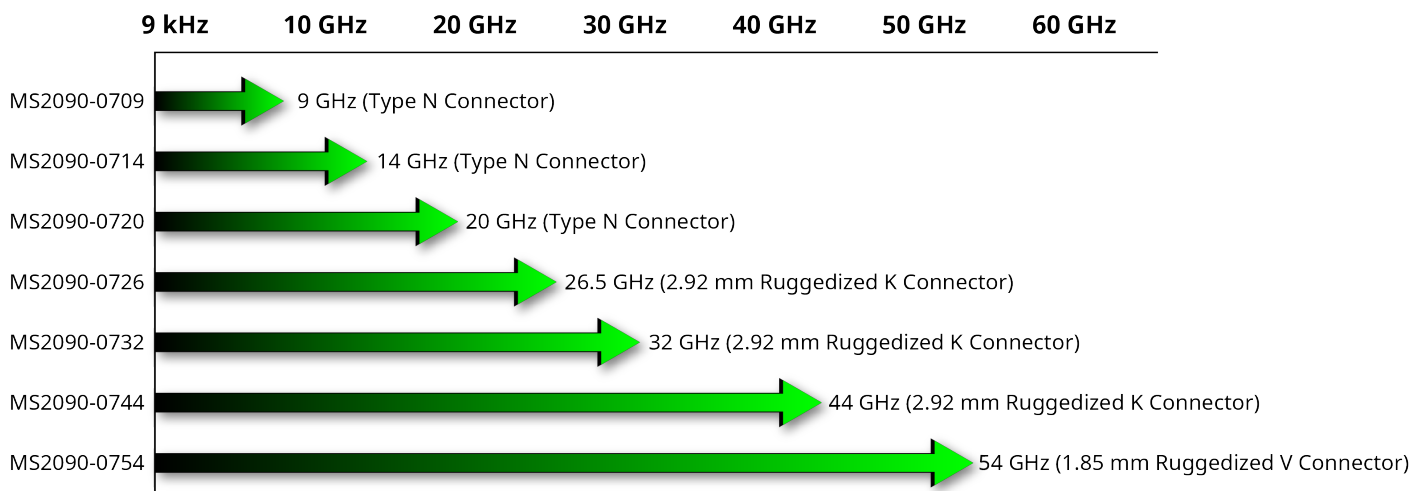

As RF technologies continue to become more ingrained in our daily lives, the RF spectrum is becoming more crowded at all frequencies. 5G radios are now being deployed at 28 GHz and 39 GHz in addition to the spectrum demands of sub-6 GHz cellular systems for mobile applications. The use of electronics in the automotive industry is growing rapidly, now with sensors for autonomous driving becoming pervasive in today's vehicles. As we all continue to consume more data and expect faster access even in remote locations, point-to-point radio links are moving higher in frequency and expanding in bandwidth to support these demands. The ability to view the RF spectrum and measure the transmissions from all of these systems is critical in order to avoid interference and guarantee performance. The Field Master Pro MS2090A high-performance RF spectrum analyzer was developed to provide field service engineers and technicians with the unparalleled performance and functionality needed to meet the growing demands of these complex systems – all in a handheld, battery-powered instrument.





## Key RF specifications

Parameter	Specification
Frequency range	9 kHz to 9/14/20/26.5/32/44/54 GHz
Analysis bandwidth	100 MHz
Demodulation	5G NR demodulation, RF and modulation quality plus SSB signal analysis
TOI	+20 dBm
DANL (with pre amp)	-164 dBm
Amp range	DANL to +30 dBm
Phase noise @ 1 GHz	-110 dBc/Hz @ 100 kHz offset (typical)
RBW/VBW	1 Hz to 10 MHz
Input SWR	1.5
Amplitude accuracy	< 14 GHz ±1.3 dB (±0.5 dB typ)
RTSA bandwidth	20 MHz to 100 MHz

## Key features

Feature	Specification
Display	10.1 inch, 1280 x 800 color touchscreen
Traces	6
Detectors	Peak, RMS/Avg., Negative
Gated sweep	For time gated spectrum measurements
Markers	12, fully featured with table
Limit lines	Complex limit lines with Pass/Fail
IQ	Capture and export of 5G waveforms
Connectivity	802.11 and Bluetooth
GNSS	GPS & GLONASS
Interfaces	USB 3.0 PCIe, Ethernet
Battery life	>2 hours (function dependent)

### Unmatched RF Performance

The Field Master Pro MS2090A device delivers the highest levels of RF performance available in a handheld, touchscreen spectrum analyzer. With a displayed average noise level (DANL) of -164 dBm and third-order intercept (TOI) of typically +20 dBm, measurements such as spectrum clearing, radio alignment, harmonic, and distortion are even more accurate than previously possible. For modulation measurements on digital systems, 100 MHz modulation bandwidth, coupled with best-in-class phase noise performance, maximizes measurement accuracy, while 0.5 dB typical amplitude accuracy provides confidence when testing transmitter power and spurious emissions.

### Feature-Rich Device Enhances Usability

All Field Master Pro MS2090A models offer a comprehensive range of features to speed and simplify measurements.

- In addition to a **full span swept-tuned spectrum analyzer and amplitude**, all versions include a **spectrogram display**. Spectrograms are a view of how the frequency content of a signal changes with time. It is especially useful when monitoring the RF spectrum for intermittent or interfering signals.
- **Integrated Channel Power and Occupied Bandwidth (OBW) measurements** simplify the analysis and characterization of common radio transmissions. Regulatory authorities typically specify limits for transmitters based on these measurements.
- The **built-in Adjacent Channel Power (ACPR) measurement** simplifies the measure of out-of-band transmitter emissions, which is required to speed conformance testing.
- The **built-in RTSA** provides the ultimate signal analysis and interference capture tool. RTSA spans of 20 MHz (standard) to 100 MHz (option) provide capability for cellular interference monitoring to full ISM band signal analysis.
- **IQ data capture** enables the capture and saving of 5G IQ data for off-line processing on a PC using standard data analysis tools. In the early stages of product testing in field trials, this enables real-world signals to be saved and analyzed, providing true insight into a product's performance.

### Rugged Design for Field Use

With years of experience designing instruments for the field, Anritsu knows how durable and robust test equipment needs to be. From cell sites in the extreme cold of the Antarctic to satellite earth stations on desert mountain tops, test instruments need to be ready, whatever the conditions. The ruggedized rubber over-mold case has been hardened to handle the knocks and blows that happen when field technicians are onsite. All connectors are protected from damage by covers or protruding instrument bezels. The large 10.1 inch color touchscreen is a toughened display designed to exceed the Impact Protection IK08 rating and standard, protecting it against 5 joules of impact (the equivalent to the impact of a 1.7 kg mass dropped from 300 mm above the impacted surface). A grab handle is located on the side and large D rings are mounted to attach the supplied shoulder strap when required.

### High-Resolution Multi-Touch Screen and Modern User Interface Eases Usability

The Field Master Pro MS2090A spectrum analyzer features menus and user interface developed to meet industry-standard guidelines for touchscreen instruments. Frequently used functions are immediately accessible and touching on-screen values opens up dialog boxes for rapid changes. Menus can be collapsed to maximize the trace display area or detailed trace settings can be displayed on the screen so that complex configurations are easily understood. Support for familiar, multi-touch gestures allows you to swipe and scan across the frequency range or pinch and zoom to quickly view signals of interest. A stylus stored in the carry handle facilitates the use of the screen even when wearing gloves or if you simply prefer a tool to your finger.



*Field Master Pro MS2090A features a 10.1 inch multi-touch screen*

The 1280 x 800 resolution screen offers excellent brightness with high-contrast color schemes. Switch between the standard color palate for normal use or a black and white high-contrast display for use in direct sunlight.



## Applications

---

### Interference hunting and spectrum clearing

The value of RF spectrum allocations has grown rapidly as cellular and broadcast operators expand their networks. Spectrum usage is changing as older technologies, such as broadcast television or private mobile radio, are moved out of the sub-6 GHz bands and new technologies take their place. Many national regulatory authorities have auctioned and reallocated the spectrum, reassigning the frequency bands for exclusive access. In order to deploy new networks efficiently, the owners of the spectrum must clear the spectrum and validate that all legacy users have stopped all transmission. The Field Master Pro MS2090A meets the requirements for spectrum clearance with its fast sweep speeds, low distortion front-end, and spectrogram display.

Using an omnidirectional antenna, all signals are captured across a defined frequency band. A built-in preamplifier optimizes the sensitivity of the Field Master Pro MS2090A instrument so that low-level signals are captured. To isolate and locate illegal or intermittent interferers, the Field Master Pro MS2090A spectrum analyzer has a range of features.

- Up to 6 traces can be individually configured to display max or min hold
- Spectrogram displays facilitate the long-term monitoring of the spectrum so that intermittent signals are captured and stored
- Power spectral density mode in the RTSA enables the identification of interfering signals that are located at the same frequency as the wanted signal but lower in power

Selecting a directional antenna, such as one of the Anritsu Yagi antennas, the fast sweep rate of the Field Master Pro MS2090A unit provides a clear picture of RF activity across a wide frequency range and at low power levels.



## Broadcast Transmitter Analysis



RF transmitters need to be tested at the time of installation and then at regular intervals to confirm they conform to regulatory requirements. The Field Master Pro MS2090A RF spectrum analyzer is ideal for a comprehensive range of transmitter measurements. Harmonic and spurious tests are required to ensure that the transmitter does not interfere with other users of the RF spectrum. These tests can be performed by connecting a cable directly to a test port or over the air (OTA) using an accessory antenna. Built-in measurement routines for occupied bandwidth, channel power, and adjacent channel power speed and simplify additional regulatory measurements. The Field Master Pro MS2090A instrument also has excellent TOI performance and distortion-free dynamic range, ensuring accurate harmonic and spurious measurements to 54 GHz (option dependent).

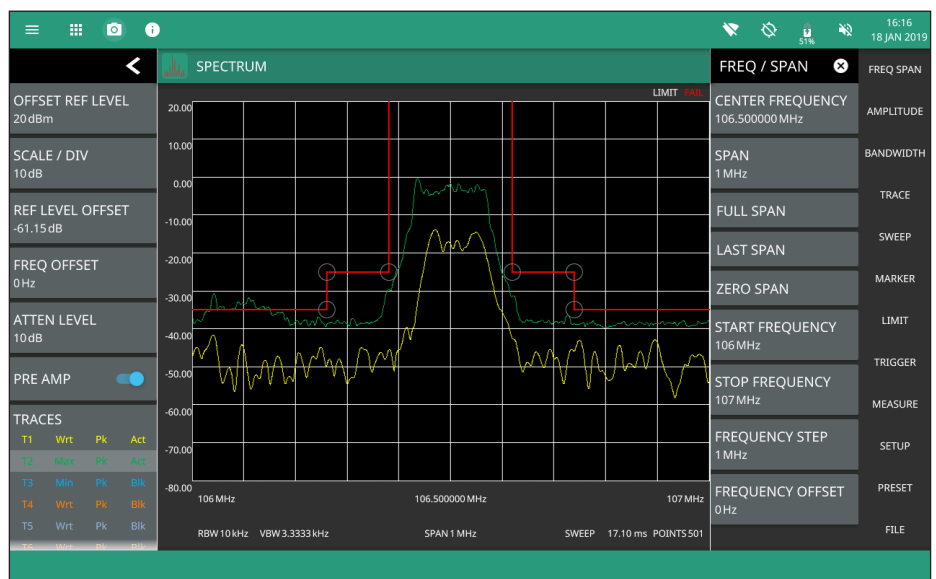



## Microwave Radio Links

Microwave radio links have become central building block of cellular and data networks. Installation crews need to align the radios over distances from a few tens of meters to several kilometers. The Field Master Pro MS2090A spectrum analyzer has frequency options to 54 GHz with exceptional sensitivity for dish alignment. Using a waveguide horn antenna, the power and modulation bandwidth can be verified at installation and during maintenance testing.

## Satellite System Monitoring

The United Nations Office for Outer Space Affairs estimates there are close to 2,000 active satellites orbiting the earth. Each of these communicates with the ground through dedicated earth stations. Common frequencies for satellite communications have been in the 2 to 4 GHz bands and 4 to 8 GHz bands. Now new bands are opening up in the 12 to 18 GHz and 26 to 40 GHz bands, and even 36 to 50 GHz. As the number of satellites increases the opportunity for interference between all the communications increases. The Field Master Pro MS2090A is ideal for monitoring downlink signals to search for interference and noise.

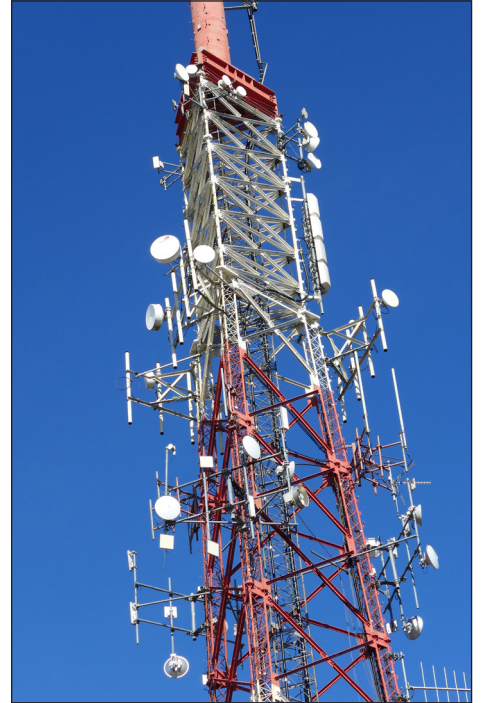

## Option 888 5G NR Base Station Measurements

The rapid introduction of 5G NR networks requires an instrument that can validate the performance of the gNB base stations quickly in a field environment. In both the 3.5 GHz bands and the millimeter-wave (mmWave) 28 GHz and 39 GHz bands, the adoption of active antenna systems means that new test methods need to be considered. Some radios may have test monitor ports integrated, but many operators will make gNB transmitter measurements OTA.

The Field Master Pro MS2090A high-performance spectrum analyzer performs the essential measurements in full compliance with the 3GPP TS 38.104 V15. Measurements supported include:

- Frequency Error
- Time Offset
- Cell/Sector ID
- Modulation Quality (EVM)
- Unwanted Emissions
- Occupied Bandwidth
- Adjacent Channel Leakage Ratio
- Transmitter Spurious to 12.75 GHz
- EIRP



Additionally, measurements of the synchronization signal block (SSB) are also supported. Making measurements on the SSB allows OTA transmitter testing on a live gNB. As well as displaying beam ID, the RSRP is graphed for each of the beams in the SSB.

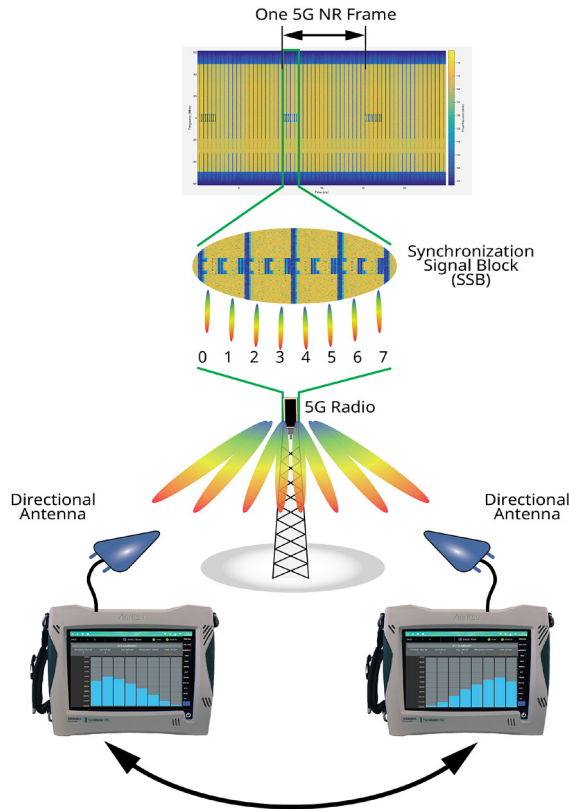

*Field Master Pro MS2090A displays RSRP vs beam index based on OTA analysis of the 5G NR SSB*

Where direct access to an RF test connector is not possible, 5G NR installation testing must be performed over the air with a directional antenna or waveguide horn antenna. Because the SSB is always transmitted, the easiest way to test an active gNB is to make measurements on these elements. The Field Master Pro MS2090A decodes all active beams in the signal, typically 8 beams for radios in the 3 to 6 GHz bands, and 64 beams in the mm wave bands around 28 GHz and 39 GHz. A measurement summary screen displays all the essential results to validate base station performance.

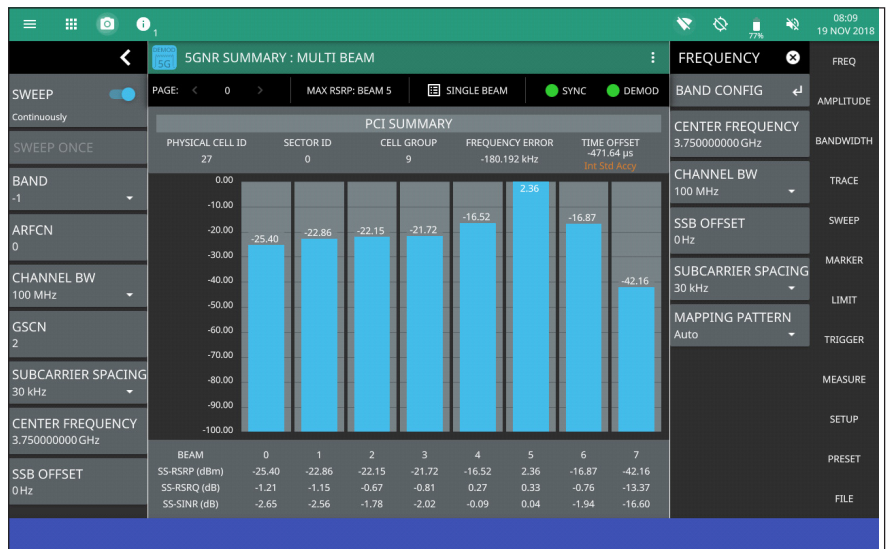

*Measurement summary screen displays essential results to validate base station performance*

A range of 3GPP-compliant spectrum measurements are supported. To measure gNB transmit power, the Field Master Pro MS2090A instrument includes EIRP and channel power measurements. Both are made OTA using a waveguide horn or broadband antenna to receive the signal. In cases where the gNB can be put into test modes and test model waveforms transmitted, a gated sweep feature enables measurements to be made on defined symbols in the 5G frame. Occupied bandwidth (OBW), adjacent channel power (ACP), and spectral emission mask (SEM) measurements have pre-configured setups to speed testing.

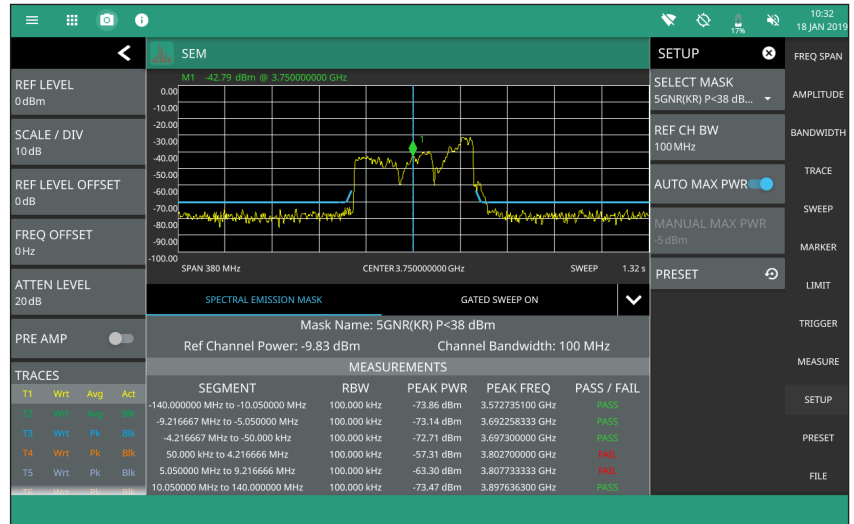

## 5G Coverage Mapping

Coverage mapping provides a clear representation of the signal strength of 5G transmitters over intended geographic area. The Field Master Pro MS2090A spectrum analyzer is configured to continuously measure RF data including 5G channel power, EIRP, or RSRP. When used with the NEON® MA8100A Signal Mapper, the results are graphically displayed on a digital map or building floor plan. The NEON MA8100A supports outdoor coverage mapping using GPS coordinates taken from the Field Master Pro MS2090A instrument's built-in GNSS receiver and indoor coverage mapping using the NEON Tracking Unit.

The NEON MA8100A solution consists of a NEON Tracking Unit, NEON Signal Mapper Software for Android devices, and NEON Command Software for a PC. For indoor coverage mapping, the NEON Tracking Unit supports the collection and processing of sensor data that delivers 3D location information. The NEON Tracking Unit connects to the NEON Signal Mapper application that is run on an Android device via a Bluetooth connection. The NEON Signal Mapper application provides an intuitive Android user interface, enabling lightly trained users to map RF signals within buildings. RF data is captured by Field Master Pro MS2090A unit and the data is sent to the Android device. For outdoor coverage mapping applications, the Field Master Pro MS2090A instrument provides both location and RF data directly to the Android device. When in 5G demod mode, for each data point the application shows which SSB beam was recording the highest signal level.

*OTA SEM measurement on a 5G NR transmission with pass/fail results*

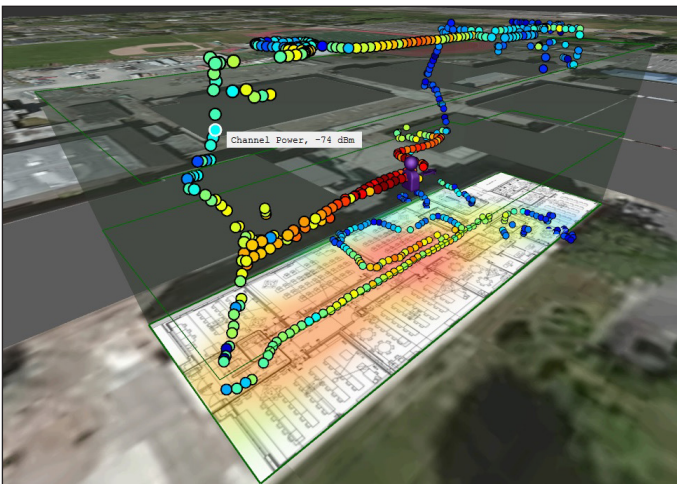

*Typical result screen for indoor coverage mapping*



*Typical result screen for outdoor coverage mapping*

## Key Features

### Multiple Traces and Detectors

Up to 6 traces can be displayed simultaneously, with each trace able to use different detector and averaging. Each trace is color-coded with an information table highlighting the detector type, averaging and status of each active trace.



### Comprehensive Markers

12 markers facilitate the rapid identification and analysis of all signals on the screen. Delta and fixed markers, with detailed results table, enable recording and archiving of results. A noise maker can be activated for noise power measurements in a 1 Hz bandwidth, and each marker can be set to initiate a true frequency count at the end of a sweep. Double tap a marker to open peak search options.

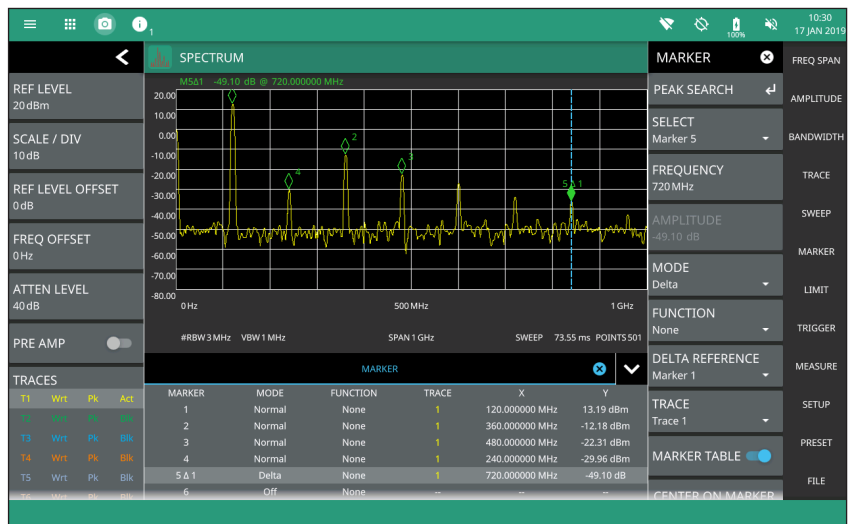

### Limit Lines with Pass/Fail

Flexible limits, from simple maximum level lines to complex envelope shapes, provide automated pass/fail indication and can be used to trigger remote alarms. Limits can be entered manually to conform to international standards or automatically generated based on the signals measured in the current trace. Save on event facilitates the capture of intermittent interferers by storing a trace each time a limit line is violated.

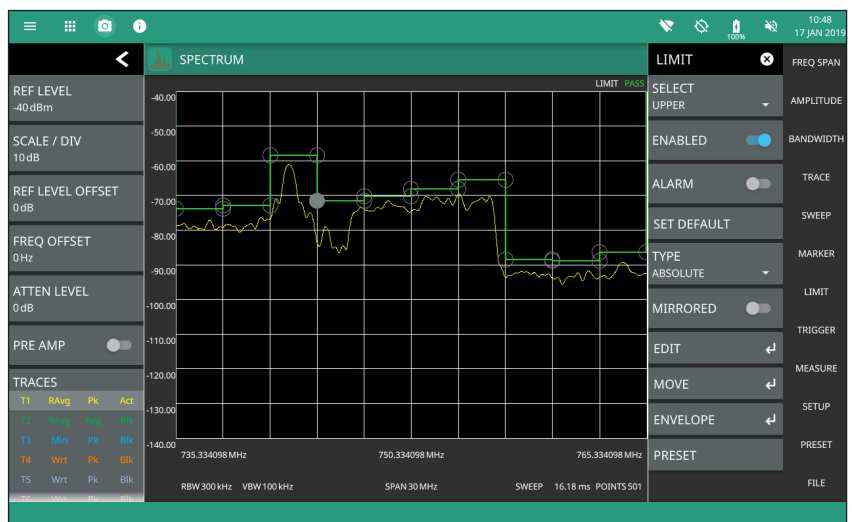



## Spectrogram

The combined spectrum and spectrogram display shows activity over time in a given spectrum band. In dynamic environments, such as the 2.4 GHz ISM band, WiFi and Bluetooth activity can be recorded over time to assess the spectral occupancy. Six cursors positioned in the spectrogram time domain define the active spectrum traces.

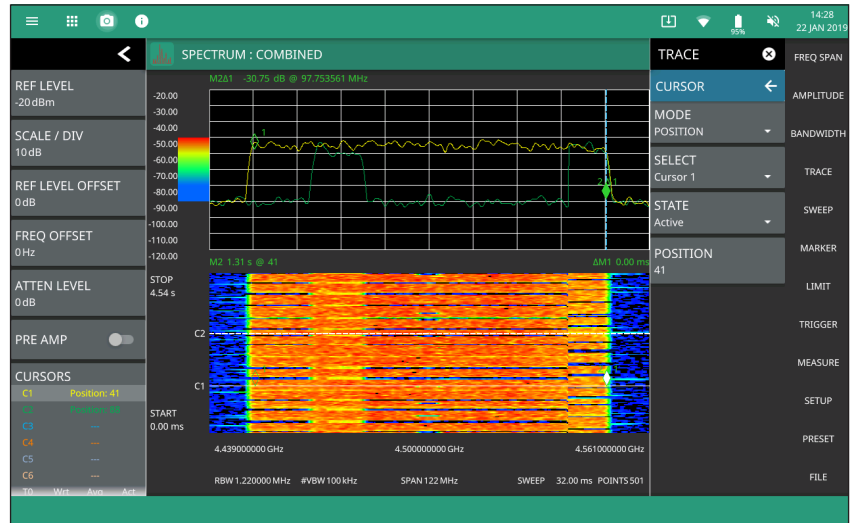

## Ethernet and WiFi Connectivity

Full remote control of all instrument functions are available using the standard Ethernet interface. The Field Master Pro MS2090A conforms to standard SCPI protocols. 802.11b/g/a/n connectivity is also supported. This WiFi interface is fully integrated into the instrument with no need for external antennas. The Field Master Pro MS2090A connects to WiFi routers enabling remote control of the instrument using IP protocols. A remote desktop tool comes standard with the Field Master Pro MS2090A solution, enabling control of the device over an internet and WiFi connection from any location.

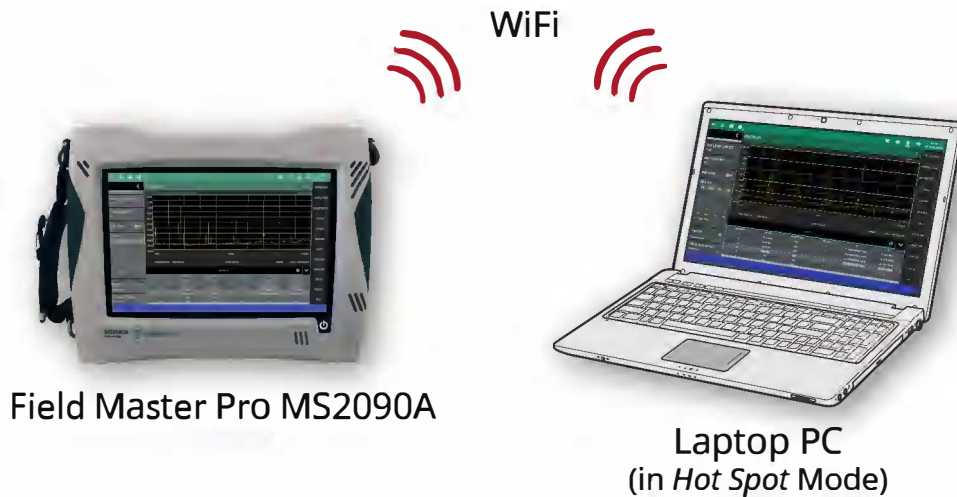

Wirelessly control Field Master Pro MS2090A from a PC

## Comprehensive Interface Selection

The Field Master Pro MS2090A spectrum analyzer comes standard with: 3 x USB 3.0 type A host ports; 1 x USB 3.0 Type C device port; and, PCIe and microSD interfaces. USB 3.0 host interfaces can be used to save screen images as a .png file, IQ data files, and facilitate software and option updates. USB Type C, PCIe, microSD, and headphone jack interfaces are provided to support future applications.

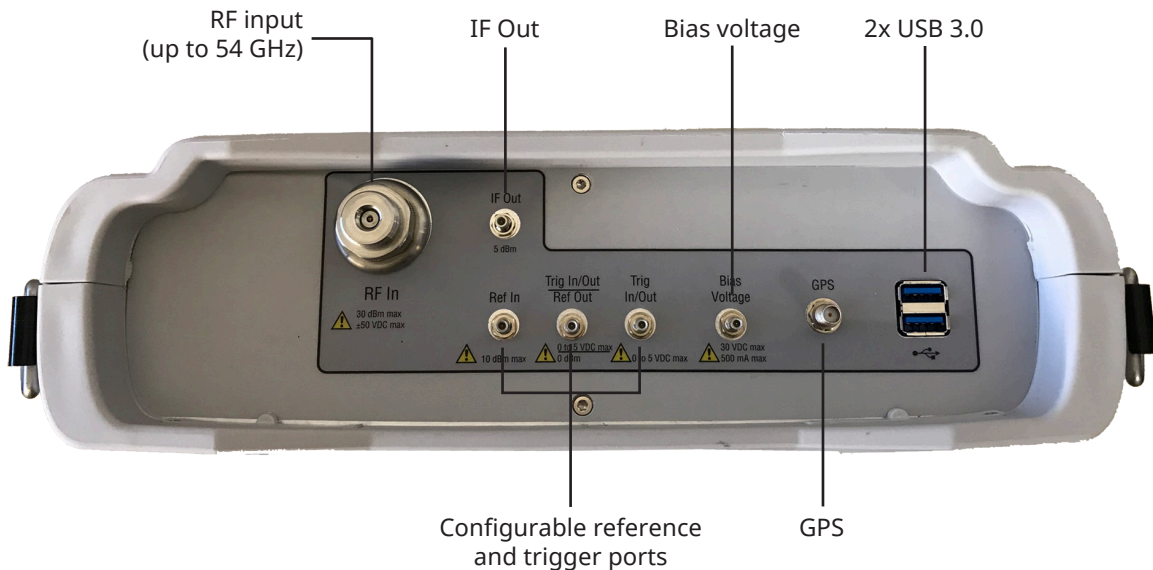
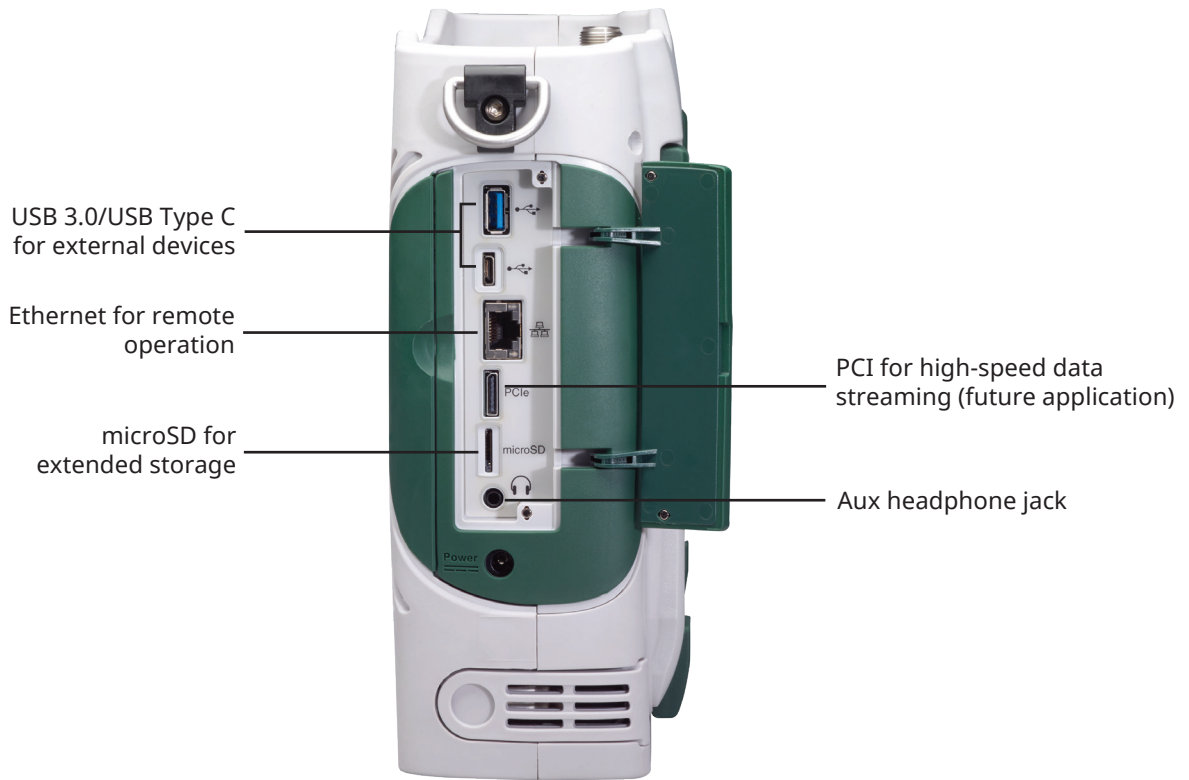

## Ordering Information – Instrument Options

Part Number	Description
MS2090A	Field Master Pro (Requires Option 709, 714, 720, 726, 732, 744, or 754)
<b>Options</b>	
MS2090A-0709	Frequency Range 9 kHz to 9 GHz
MS2090A-0714	Frequency Range 9 kHz to 14 GHz
MS2090A-0720	Frequency Range 9 kHz to 20 GHz
MS2090A-0726	Frequency Range 9 kHz to 26.5 GHz
MS2090A-0732	Frequency Range 9 kHz to 32 GHz
MS2090A-0744 <sup>a</sup>	Frequency Range 9 kHz to 44 GHz
MS2090A-0754 <sup>a</sup>	Frequency Range 9 kHz to 54 GHz
MS2090A-0031	GPS Receiver (Requires GPS Antenna, sold separately) - 2000-1528-R GPS Antenna, SMA(m) with 5 m (15 ft) cable, requires 5 VDC - 2000-1652-R GPS Antenna, SMA(m) with 0.3 m (1 ft) cable, requires 3.3 VDC or 5 VDC - 2000-1760-R GPS antenna, SMA(m) with no cable, 2.5 VDC to 3.7 VDC
MS2090A-xxxx-0097	Accredited Calibration to ISO17025 and ANSI/NCSL Z540-1 (xxxx is the frequency option number)
MS2090A-xxxx-0098	Standard Calibration to ISO17025 and ANSI/NCSL Z540-1 (xxxx is the frequency option number)
MS2090A-xxxx-0099	Premium Calibration to ISO17025 and ANSI/NCSL Z540-1 plus test data (xxxx is the frequency option number)
MS2090A-0103	50 MHz Analysis Bandwidth (for MS2090A 9, 14, 20, or 26.5 GHz units only)
MS2090A-0104	100 MHz Analysis Bandwidth (for MS2090A 9, 14, 20, or 26.5 GHz units only)
MS2090A-0105 <sup>a</sup>	50 MHz Analysis Bandwidth (for MS2090A 32, 44, or 54 GHz units only)
MS2090A-0106 <sup>a</sup>	100 MHz Analysis Bandwidth (for MS2090A 32, 44, or 54 GHz units only)
MS2090A-0199	Real Time Spectrum Analyzer
MS2090A-0888	5G NR Downlink Measurements (requires GPS option MS2090A-0031)

a. These option have an ECCN code of 3A002 and are controlled items that may require an export license.

## Standard Accessories (included with instrument)

Part Number	Description
2000-1371-R	Ethernet Cable, 7 ft/213 cm
2000-1931-R	Stylus
3-2000-1928	Shoulder Strap
633-75	Li-Ion Battery
40-204-R	AC/DC Power Supply (Field Master Series)
2000-1859-R	USB Cable, USB 3.0 Type-A to Type-C, 1 m
2000-1938-R	SMB Plug to BNC Jack Adapter (qty 3)
806-366-R	BNC to SMB Cable, 1 m
##	Certificate of Calibration and Conformance

## Optional Accessories

### Miscellaneous Accessories



Part Number	Description
67135	Anritsu Backpack (for Handheld Instrument and PC)
760-243-R	Large Transit Case with Wheels and Handle 56 cm x 45.5 cm x 26.5 cm (22.07" x 17.92" x 10.42")
40-207-R	Automotive DC/DC Power Adapter (Field Master Series)
2000-1374	External Dual Charger for Li-Ion Batteries

### GPS Antennas



Part Number	Description
2000-1528-R	GPS Antenna, SMA(m) with 5 m (15 ft) cable, requires 5 VDC
2000-1652-R	GPS Antenna, SMA(m) with 0.3 m (1 ft) cable, requires 3.3 VDC or 5 VDC
2000-1760-R	GPS Antenna, SMA(m), 25 dB gain, 2.5 VDC to 3.7 VDC

### Mag Mount and Broadband Antennas



Part Number	Description
2000-1616-R	20 MHz to 21000 MHz, N(f), 50 Ω
2000-1645-R	694 MHz to 894 MHz, 3 dBi peak gain 1700 MHz to 2700 MHz, 3 dBi peak gain, N(m), 50 Ω, 10 ft
2000-1646-R	750 MHz to 1250 MHz, 3 dBi peak gain, 1650 MHz to 2000 MHz, 5 dBi peak gain, 2100 MHz to 2700 MHz, 5 dBi peak gain, N(m), 50 Ω, 10 ft
2000-1647-R	Cable 1: 698 MHz to 1200 MHz, 2 dBi peak gain, 1700 MHz to 2700 MHz, 5 dBi peak gain, N(m), 50 Ω, 10 ft Cable 2: 3000 MHz to 6000 MHz, 5 dBi peak gain, N(m), 50 Ω, 10 ft Cable 3: GPS 26 dB gain, SMA(m), 50 Ω, 10 ft
2000-1648-R	1700 MHz to 6000 MHz, 3 dBi peak gain, N(m), 50 Ω, 10 ft

### Directional Antennas



Part Number	Description
2000-1411-R	824 MHz to 896 MHz, N(f), 12.3 dBi, Yagi
2000-1412-R	885 MHz to 975 MHz, N(f), 12.6 dBi, Yagi
2000-1413-R	1710 MHz to 1880 MHz, N(f), 12.3 dBi, Yagi
2000-1414-R	1850 MHz to 1990 MHz, N(f), 11.4 dBi, Yagi
2000-1415-R	2400 MHz to 2500 MHz, N(f), 14.1 dBi, Yagi
2000-1416-R	1920 MHz to 2170 MHz, N(f), 14.3 dBi, Yagi
2000-1659-R	698 MHz to 787 MHz, N(f), 10.1 dBi, Yagi
2000-1660-R	1425 MHz to 1535 MHz, N(f), 14.3 dBi, Yagi
2000-1715-R	Directional Antenna, 698 MHz to 2500 MHz, N(f), gain of 2 dBi to 10 dBi, typical
2000-1726-R	Antenna, 2500 MHz to 2700 MHz, N(f), 14.1 dBi, Yagi
2000-1747-R	Antenna, Log Periodic, 300 MHz to 7000 MHz, N(f), 5.1 dBi, typical
2000-1748-R	Antenna, Log Periodic, 1 GHz to 18 GHz, N(f), 6 dBi, typical
2000-1777-R	Portable Directional Antenna, 9 kHz to 20 MHz, N(f)
2000-1778-R	Portable Directional Antenna, 20 MHz to 200 MHz, N(f)
2000-1779-R	Portable Directional Antenna, 200 MHz to 500 MHz, N(f)
2000-1812-R	Portable Yagi Antenna, 450 MHz to 512 MHz, N(f), 7.1 dBi
2000-1825-R	Portable Yagi Antenna, 380 MHz to 430 MHz, N(f), 7.1 dBi



## Optional Accessories (continued)

---

### Portable Antennas



Part Number	Description
2000-1200-R	806 MHz to 866 MHz, SMA(m), 50 Ω
2000-1473-R	870 MHz to 960 MHz, SMA(m), 50 Ω
2000-1035-R	896 MHz to 941 MHz, SMA(m), 50 Ω (1/2 wave)
2000-1030-R	1710 MHz to 1880 MHz, SMA(m), 50 Ω (1/2 wave)
2000-1474-R	1710 MHz to 1880 MHz with knuckle elbow (1/2 wave)
2000-1031-R	1850 MHz to 1990 MHz, SMA(m), 50 Ω (1/2 wave)
2000-1475-R	1920 MHz to 1980 MHz and 2110 MHz to 2170 MHz, SMA(m), 50 Ω
2000-1032-R	2400 MHz to 2500 MHz, SMA(m), 50 Ω (1/2 wave)
2000-1361-R	2400 MHz to 2500 MHz, 5000 MHz to 6000 MHz, SMA(m), 50 Ω
2000-1751-R	698 MHz to 960 MHz, 1710 MHz to 2100 MHz, 2500 MHz to 2700 MHz, SMA(m), 2 dB, typical, 50 Ω
2000-1636-R	Antenna Kit (Consists of: 2000-1030-R, 2000-1031-R, 2000-1032-R, 2000-1200-R, 2000-1035-R, 2000-1361-R, and carrying pouch)

### Directional Horn Antennas



Part Number	Description
2000-1867-R	17.6 GHz to 26.7 GHz, WR42, 25 dBi gain
2000-1868-R	26.4 GHz to 40.1 GHz, WR28, 25 dBi gain
2000-1869-R	33.0 GHz to 50.1 GHz, WR22, 25 dB gain
2000-1870-R	39.3 GHz to 59.7 GHz, WR19, 25 dBi gain

## Optional Accessories (continued)

### Bandpass Filters



Part Number	Description
1030-114-R	806 MHz to 869 MHz, N(m) to SMA(f), 50 Ω
1030-109-R	824 MHz to 849 MHz, N(m) to SMA(f), 50 Ω
1030-110-R	880 MHz to 915 MHz, N(m) to SMA(f), 50 Ω
1030-111-R	1850 MHz to 1910 MHz, N(m) to SMA(f), 50 Ω
1030-112-R	2400 MHz to 2484 MHz, N(m) to SMA(f), 50 Ω
1030-105-R	890 MHz to 915 MHz, N(m) to N(f), 50 Ω
1030-106-R	1710 MHz to 1790 MHz, N(m) to N(f), 50 Ω
1030-107-R	1910 MHz to 1990 MHz, N(m) to N(f), 50 Ω
1030-149-R	High Pass, 150 MHz, N(m) to N(f), 50 Ω
1030-150-R	High Pass, 400 MHz, N(m) to N(f), 50 Ω
1030-151-R	High Pass, 700 MHz, N(m) to N(f), 50 Ω
1030-152-R	Low Pass, 200 MHz, N(m) to N(f), 50 Ω
1030-153-R	Low Pass, 550 MHz, N(m) to N(f), 50 Ω
1030-155-R	2500 MHz to 2700 MHz, N(m) to N(f), 50 Ω
1030-178-R	1920 MHz to 1980 MHz, N(m) to N(f), 50 Ω
1030-179-R	777 MHz to 798 MHz, N(m) to N(f), 50 Ω
1030-180-R	2500 MHz to 2570 MHz, N(m) to N(f), 50 Ω
2000-1684-R	791 MHz to 821 MHz, N(m) to N(f), 50 Ω
2000-1734-R	Bandpass Filter, 699 MHz to 715 MHz, N(m) and N(f), 50 Ω
2000-1735-R	Bandpass Filter, 776 MHz to 788 MHz, N(m) and N(f), 50 Ω
2000-1736-R	Bandpass Filter, 815 MHz to 850 MHz, N(m) and N(f), 50 Ω
2000-1737-R	Bandpass Filter, 1711 MHz to 1756 MHz, N(m) and N(f), 50 Ω
2000-1738-R	Bandpass Filter, 1850 MHz to 1910 MHz, N(m) and N(f), 50 Ω
2000-1739-R	Bandpass Filter, 880 MHz to 915 MHz, N(m) and N(f), 50 Ω
2000-1740-R	Bandpass Filter, 1710 MHz to 1785 MHz, N(m) and N(f), 50 Ω
2000-1741-R	Bandpass Filter, 1920 MHz to 1980 MHz, N(m) and N(f), 50 Ω
2000-1742-R	Bandpass Filter, 832 MHz to 862 MHz, N(m) and N(f), 50 Ω
2000-1743-R	Bandpass Filter, 2500 MHz to 2570 MHz, N(m) and N(f), 50 Ω
2000-1799-R	Bandpass Filter, 2305 MHz to 2320 MHz, N(m) and N(f), 50 Ω



### Attenuators

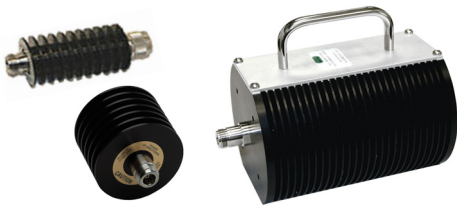

Part Number	Description
3-1010-122	20 dB, 5 W, DC to 12.4 GHz, N(m) to N(f)
42N50-20	20 dB, 5 W, DC to 18 GHz, N(m) to N(f)
42N50A-30	30 dB, 50 W, DC to 18 GHz, N(m) to N(f)
3-1010-123	30 dB, 50 W, DC to 8.5 GHz, N(m) to N(f)
1010-127-R	30 dB, 150 W, DC to 3 GHz, N(m) to N(f)
1010-121	Attenuator, 40 dB, 100 W, DC-18 GHz, N(f) input - N(m) output, UniDirectional
3-1010-124	Attenuator, 40 dB, 100 W, DC-8.5 GHz, N(f) input - N(m) output, Uni-directional
1010-128-R	40 dB, 150 W, DC to 3 GHz, N(m) to N(f)

## Optional Accessories (continued)

### Precision Fixed Attenuators



Part Number	Description
41KB-3	DC to 26.5 GHz, 1W, 3 dB, K(m) to K(f)
41KB-6	DC to 26.5 GHz, 1W, 6 dB, K(m) to K(f)
41KB-10	DC to 26.5 GHz, 1W, 10 dB, K(m) to K(f)
41KB-20	DC to 26.5 GHz, 1W, 20 dB, K(m) to K(f)
41KC-3	DC to 40 GHz, 1W, 3 dB, K(m) to K(f)
41KC-6	DC to 40 GHz, 1W, 6 dB, K(m) to K(f)
41KC-10	DC to 40 GHz, 1W, 10 dB, K(m) to K(f)
41KC-20	DC to 40 GHz, 1W, 20 dB, K(m) to K(f)
41V-3	DC to 65 GHz, 1W, 3 dB, V(m) to V(f)
41V-6	DC to 65 GHz, 1W, 6 dB, V(m) to V(f)
41V-10	DC to 65 GHz, 1W, 10 dB, V(m) to V(f)
41V-20	DC to 65 GHz, 1W, 20 dB, V(m) to V(f)

### Precision Adapters



Part Number	Description
34NN50A	Precision Adapter, N(m) to N(m), DC to 18 GHz, 50 Ω
34NFN50	Precision Adapter, N(f) to N(f), DC to 18 GHz, 50 Ω

### Adapters



Part Number	Description
1091-26-R	SMA(m) to N(m), DC to 18 GHz, 50 Ω
1091-27-R	SMA(f) to N(m), DC to 18 GHz, 50 Ω
1091-80-R	SMA(m) to N(f), DC to 18 GHz, 50 Ω
1091-81-R	SMA(f) to N(f), DC to 18 GHz, 50 Ω
1091-172-R	BNC(f) to N(m), DC to 1.3 GHz, 50 Ω
1091-417-R	N(m) to QMA(f), DC to 6 GHz, 50 Ω
1091-418-R	N(m) to QMA(m), DC to 18 GHz, 50 Ω
510-90-R	7/16 DIN(f) to N(m), DC to 7.5 GHz, 50 Ω
510-91-R	7/16 DIN(f) to N(f), DC to 7.5 GHz, 50 Ω
510-92-R	7/16 DIN(m) to N(m), DC to 7.5 GHz, 50 Ω
510-93-R	7/16 DIN(m) to N(f), DC to 7.5 GHz, 50 Ω
510-96-R	7/16 DIN(m) to 7/16 DIN (m), DC to 7.5 GHz, 50 Ω
510-97-R	7/16 DIN(f) to 7/16 DIN (f), DC to 7.5 GHz, 50 Ω
71693-R	Ruggedized K(f) to N(f)
34NMDVFN50	Ruggedized V(f) to N(f)
510-102-R	N(m) to N(m), DC to 11 GHz, 50 Ω, 90 degrees right angle
2000-1938-R	SMB Plug to BNC Jack Adapter

### Coaxial Adapters



Part Number	Description
2000-1880-R	DC to 18 GHz, N(m) to V(f), 50 Ω
2000-1881-R	DC to 18 GHz, N(f) to V(f), 50 Ω
K222B	DC to 40 GHz, K(f) to K(f), 50 Ω
34VFK50	DC to 40 GHz, V(f) to K(m), 50 Ω
34VFKF50	DC to 40 GHz, V(f) to K(f), 50 Ω
34VV50	DC to 65 GHz, V(m) to V(m), 50 Ω
34VVF50	DC to 65 GHz, V(f) to V(m), 50 Ω
34VVF50	DC to 65 GHz, V(f) to V(f), 50 Ω

## Optional Accessories (continued)

---

### Precision Waveguide Coaxial Adapters (right angle)



Part Number	Description
35WR42KF	18 GHz to 26.5 GHz, WR42 to K(f)
35WR28KF	26.5 GHz to 40 GHz, WR28 to K(f)
35WR22VF	33 GHz to 50 GHz, WR22 to V(f)
35WR19VF	40 GHz to 60 GHz, WR19 to V(f)
35WR15VF	50 GHz to 65 GHz, WR15 to V(f)

### Waveguide to Coaxial End Launch Adapters (straight through)



Part Number	Description
2000-1889-R	17.6 GHz to 26.7 GHz, WR42 to K(f)
2000-1890-R	26.4 GHz to 40.1 GHz, WR28 to K(f)
1091-460-R	17.6 GHz to 26.7 GHz, WR42 to V(f)
1091-459-R	26.4 GHz to 40.1 GHz, WR28 to V(f)
1091-458-R	33.0 GHz to 50.1 GHz, WR22 to V(f)
1091-457-R	39.3 GHz to 59.7 GHz, WR19 to V(f)
1091-456-R	49.9 GHz to 67.0 GHz, WR15 to V(f)

### Test Port Cables (Armored, Semi-rigid)



Part Number	Description
3670K50-1	DC to 40 GHz, K(f) to K(m), 30.5 cm (1 ft)
3670K50-2	DC to 40 GHz, K(f) to K(m), 61.0 cm (2 ft)
3670V50A-1	DC to 70 GHz, V(f) to V(m), 30.5 cm (1 ft)
3670V50A-2	DC to 70 GHz, V(f) to V(m), 61.0 cm (2 ft)



• **United States**

**Anritsu Company**

450 Century Parkway, Suite 190, Allen,  
TX 75013 U.S.A.  
Phone: +1-800-Anritsu (1-800-267-4878)

• **Canada**

**Anritsu Electronics Ltd.**

700 Silver Seven Road, Suite 120,  
Kanata, Ontario K2V 1C3, Canada  
Phone: +1-613-591-2003  
Fax: +1-613-591-1006

• **Brazil**

**Anritsu Eletrônica Ltda.**

Praça Amadeu Amaral, 27 - 1 Andar  
01327-010 - Bela Vista - Sao Paulo - SP - Brazil  
Phone: +55-11-3283-2511  
Fax: +55-11-3288-6940

• **Mexico**

**Anritsu Company, S.A. de C.V.**

Blvd Miguel de Cervantes Saavedra #169 Piso 1, Col. Granada  
Mexico, Ciudad de Mexico, 11520, MEXICO  
Phone: +52-55-4169-7104

• **United Kingdom**

**Anritsu EMEA Ltd.**

200 Capability Green, Luton, Bedfordshire LU1 3LU, U.K.  
Phone: +44-1582-433200  
Fax: +44-1582-731303

• **France**

**Anritsu S.A.**

12 avenue du Québec, Batiment Iris 1-Silic 612,  
91140 VILLEBON-SUR-YVETTE, France  
Phone: +33-1-60-92-15-50  
Fax: +33-1-64-46-10-65

• **Germany**

**Anritsu GmbH**

Nemetschek Haus, Konrad-Zuse-Platz 1  
81829 München, Germany  
Phone: +49-89-442308-0  
Fax: +49-89-442308-55

• **Italy**

**Anritsu S.r.l.**

Via Elio Vittorini 129, 00144 Roma Italy  
Phone: +39-06-509-9711  
Fax: +39-6-502-2425

• **Sweden**

**Anritsu AB**

Isafjordsgatan 32C, 164 40 KISTA, Sweden  
Phone: +46-8-534-707-00

• **Finland**

**Anritsu AB**

Teknobulevardi 3-5, FI-01530 VANTAA, Finland  
Phone: +358-20-741-8100  
Fax: +358-20-741-8111

• **Denmark**

**Anritsu A/S**

Torveporten 2, 2500 Valby, Denmark  
Phone: +45-7211-2200  
Fax: +45-7211-2210

• **Russia**

**Anritsu EMEA Ltd.**

**Representation Office in Russia**

Tverskaya str. 16/2, bld. 1, 7th floor.  
Moscow, 125009, Russia  
Phone: +7-495-363-1694  
Fax: +7-495-935-8962

• **Spain**

**Anritsu EMEA Ltd.**

**Representation Office in Spain**

Edificio Cuzco IV, Po. de la Castellana, 141, Pta. 5  
28046, Madrid, Spain  
Phone: +34-915-726-761  
Fax: +34-915-726-621

• **United Arab Emirates**

**Anritsu EMEA Ltd.**

**Dubai Liaison Office**

902, Aurora Tower,  
P O Box: 500311- Dubai Internet City  
Dubai, United Arab Emirates  
Phone: +971-4-3758479  
Fax: +971-4-4249036

• **India**

**Anritsu India Pvt Ltd.**

6th Floor, Indiqube ETA, No.38/4, Adjacent to EMC2,  
Doddanekundi, Outer Ring Road, Bengaluru - 560048, India  
Phone: +91-80-6728-1300  
Fax: +91-80-6728-1301

• **Singapore**

**Anritsu Pte. Ltd.**

11 Chang Charn Road, #04-01, Shriro House  
Singapore 159640  
Phone: +65-6282-2400  
Fax: +65-6282-2533

• **P. R. China (Shanghai)**

**Anritsu (China) Co., Ltd.**

Room 2701-2705, Tower A,  
New Caohejing International Business Center  
No. 391 Gui Ping Road Shanghai, 200233, P.R. China  
Phone: +86-21-6237-0898  
Fax: +86-21-6237-0899

• **P. R. China (Hong Kong)**

**Anritsu Company Ltd.**

Unit 1006-7, 10/F., Greenfield Tower, Concordia Plaza,  
No. 1 Science Museum Road, Tsim Sha Tsui East,  
Kowloon, Hong Kong, P. R. China  
Phone: +852-2301-4980  
Fax: +852-2301-3545

• **Japan**

**Anritsu Corporation**

8-5, Tamura-cho, Atsugi-shi, Kanagawa, 243-0016 Japan  
Phone: +81-46-296-6509  
Fax: +81-46-225-8352

• **Korea**

**Anritsu Corporation, Ltd.**

5FL, 235 Pangyoyeok-ro, Bundang-gu, Seongnam-si,  
Gyeonggi-do, 13494 Korea  
Phone: +82-31-696-7750  
Fax: +82-31-696-7751

• **Australia**

**Anritsu Pty Ltd.**

Unit 20, 21-35 Ricketts Road,  
Mount Waverley, Victoria 3149, Australia  
Phone: +61-3-9558-8177  
Fax: +61-3-9558-8255

• **Taiwan**

**Anritsu Company Inc.**

7F, No. 316, Sec. 1, NeiHu Rd., Taipei 114, Taiwan  
Phone: +886-2-8751-1816  
Fax: +886-2-8751-1817



Anritsu utilizes recycled paper and environmentally conscious inks and toner.



® Anritsu All trademarks are registered trademarks of their respective owners. Data subject to change without notice. For the most recent specifications visit: [www.anritsu.com](http://www.anritsu.com)