

Model 8009 Resistivity Test Fixture

Instruction Manual

Contains Operating and Servicing Information

8009-901-01 Rev. C

KEITHLEY

A GREATER MEASURE OF CONFIDENCE

WARRANTY

Keithley Instruments, Inc. warrants this product to be free from defects in material and workmanship for a period of 1 year from date of shipment.

Keithley Instruments, Inc. warrants the following items for 90 days from the date of shipment: probes, cables, rechargeable batteries, diskettes, and documentation.

During the warranty period, we will, at our option, either repair or replace any product that proves to be defective.

To exercise this warranty, write or call your local Keithley representative, or contact Keithley headquarters in Cleveland, Ohio. You will be given prompt assistance and return instructions. Send the product, transportation prepaid, to the indicated service facility. Repairs will be made and the product returned, transportation prepaid. Repaired or replaced products are warranted for the balance of the original warranty period, or at least 90 days.

LIMITATION OF WARRANTY

This warranty does not apply to defects resulting from product modification without Keithley's express written consent, or misuse of any product or part. This warranty also does not apply to fuses, software, non-rechargeable batteries, damage from battery leakage, or problems arising from normal wear or failure to follow instructions.

THIS WARRANTY IS IN LIEU OF ALL OTHER WARRANTIES, EXPRESSED OR IMPLIED, INCLUDING ANY IMPLIED WARRANTY OF MERCHANTABILITY OR FITNESS FOR A PARTICULAR USE. THE REMEDIES PROVIDED HEREIN ARE BUYER'S SOLE AND EXCLUSIVE REMEDIES.

NEITHER KEITHLEY INSTRUMENTS, INC. NOR ANY OF ITS EMPLOYEES SHALL BE LIABLE FOR ANY DIRECT, INDIRECT, SPECIAL, INCIDENTAL OR CONSEQUENTIAL DAMAGES ARISING OUT OF THE USE OF ITS INSTRUMENTS AND SOFTWARE EVEN IF KEITHLEY INSTRUMENTS, INC., HAS BEEN ADVISED IN ADVANCE OF THE POSSIBILITY OF SUCH DAMAGES. SUCH EXCLUDED DAMAGES SHALL INCLUDE, BUT ARE NOT LIMITED TO: COSTS OF REMOVAL AND INSTALLATION, LOSSES SUSTAINED AS THE RESULT OF INJURY TO ANY PERSON, OR DAMAGE TO PROPERTY.

KEITHLEY

Keithley Instruments, Inc. • 28775 Aurora Road • Cleveland, Ohio 44139 • (216) 248-0400 • Fax: (216) 248-6168

CHINA:

Holiday Inn Lido • Office Building 404C • Beijing, China, 100004 • 861-4362871 • 861-4362871

FRANCE:

3 Allée des Garays • B.P. 60 • 91121 Palaiseau Cédex • 01-60-11-51-55 • Fax: 01-60-11-77-26

GERMANY:

Landsberger Str. 65 • 82110 Germering • 089-849307-0 • Fax: 089-84930759

GREAT BRITAIN:

The Minster • 58 Portman Road • Reading, Berkshire RG3 1EA • 0734-575666 • Fax: 0734-596469

ITALY:

Viale S. Gimignano 38 • 20146 Milano • 02-48303008 • Fax: 02-48302274

JAPAN:

Sumiyoshi 24 Bldg., Room 201 • 2-24-2 Sumiyoshi-cho • Naka-ku, Yokohama 231 • 81-45-201-2246 • Fax: 81-45-201-2247

NETHERLANDS:

Avelingen West 49 • 4202 MS Gorinchem • Postbus 559 • 4200 AN Gorinchem • 01830-35333 • Fax: 01830-30821

SWITZERLAND:

Kriesbachstrasse 4 • 8600 Dübendorf • 01-821-9444 • Fax: 01-820-3081

TAIWAN:

3rd Floor, Number 6 • Section 3, Min Chuan East Road • Taipei, R.O.C. • 886-2-509-4465 • Fax: 886-2-509-4473

Model 8009 Resistivity Test Fixture Instruction Manual

©2008, Keithley Instruments, Inc.
Test Instrumentation Group
All rights reserved.
Cleveland, Ohio, U.S.A.
May 2008, Third Printing
Document Number: 8009-901-01 Rev. C

SAFETY PRECAUTIONS

The following safety precautions should be observed before using this product and any associated instrumentation. Although some instruments and accessories would normally be used with non-hazardous voltages, there are situations where hazardous conditions may be present.

This product is intended for use by qualified personnel who recognize shock hazards and are familiar with the safety precautions required to avoid possible injury. Read the operating information carefully before using the product.

Exercise extreme caution when a shock hazard is present. Lethal voltage may be present on cable connector jacks or test fixtures. The American National Standards Institute (ANSI) states that a shock hazard exists when voltage levels greater than 30V RMS, 42.4V peak, or 60VDC are present. **A good safety practice is to expect that hazardous voltage is present in any unknown circuit before measuring.**

Before operating an instrument, make sure the line cord is connected to a properly grounded power receptacle. Inspect the connecting cables, test leads, and jumpers for possible wear, cracks, or breaks before each use.

For maximum safety, do not touch the product, test cables, or any other instruments while power is applied to the circuit under test. ALWAYS remove power from the entire test system and discharge any capacitors before: connecting or disconnecting cables or jumpers, installing or removing switching cards, or making internal changes, such as installing or removing jumpers.

Do not touch any object that could provide a current path to the common side of the circuit under test or power line (earth) ground. Always make measurements with dry hands while standing on a dry, insulated surface capable of withstanding the voltage being measured.

Do not exceed the maximum signal levels of the instruments and accessories, as defined in the specifications and operating information, and as shown on the instrument or test fixture rear panel, or switching card.

Do not connect switching cards directly to unlimited power circuits. They are intended to be used with impedance limited sources. NEVER connect switching cards directly to AC main. When connecting sources to switching cards, install protective devices to limit fault current and voltage to the card.

When fuses are used in a product, replace with same type and rating for continued protection against fire hazard.

Chassis connections must only be used as shield connections for measuring circuits, NOT as safety earth ground connections.

If you are using a test fixture, keep the lid closed while power is applied to the device under test. Safe operation requires the use of a lid interlock.

If a  screw is present on the test fixture, connect it to safety earth ground using #18 AWG or larger wire.

The  symbol on an instrument or accessory indicates that 1000V or more may be present on the terminals. Refer to the product manual for detailed operating information.

Instrumentation and accessories should not be connected to humans.

Maintenance should be performed by qualified service personnel. Before performing any maintenance, disconnect the line cord and all test cables.

Specifications

Operating Voltages:

1kV Peak Source (safety banana plugs supplied with 6517).

200V Peak Measure (triax, 3-lug).

200V Peak Common mode.

0.1A Peak Test Current.

1VA.

Volume Resistivity Range: 10^3 to 10^{18} Ohm-cm.

Surface Resistivity Range: 10^3 to 10^{17} Ohm.

Center Electrode: 50.8mm O.D. \pm 0.05mm (2.0 in. \pm 0.002 in.) conductive rubber pad.

Electrode Concentricity: Within 0.01 in. of center of ring electrode.

Ring Electrode: 57.2mm I.D. \pm 0.05mm (2.25 in. \pm 0.002 in.).

Top Electrode: 85.7mm O.D. \pm 0.05mm, (3.375 in. \pm 0.002 in.), 54mm diameter (2.125 in.) conductive rubber pad.

Electrode Material: Type #303 Stainless.

Pad Durometer: 70 Shore A.

Pad Resistivity: Volume = 10%/square max.

Sample Size (Min.): 63.5mm diameter (2.5 in.) (surface).

Sample Size (Max.): 101.6mm sq. \times 3.2mm thick (4 in. \times 0.125 in.).

Interlock: 4 pin for use with 6517.

Test Force:

Center Electrode: 6 lbs. min.; 1.9 psi, 13.2 kPa.

10 lbs max.; 3.2 psi, 21.9 kPa.

Ring Electrode: 2 lbs. min.; 9.3 psi, 64.1 kPa.

23 lbs. max.; 107 psi, 737.6 kPa

(dependent upon sample thickness).

Operating Temperature: -30°C to $+80^{\circ}\text{C}$.

Operating Humidity: 0% R.H. to 65% R.H. up to 35°C , linearly derate 3% R.H. per degree above 35°C .

Dimensions: 107.95mm high \times 165.1mm wide \times 139.7mm deep (4.25 in. \times 6.5 in. \times 5.5 in.).

Weight: 1.45kg (3.19 lbs.).

Specifications subject to change without notice.

Table of Contents

Section 1 — General Information

1.1	Introduction	1
1.2	Supplied accessories	1
1.3	Safety information	2

Section 2 — Operation

2.1	Overview	5
2.2	ASTM standard	8
2.3	Insulator sample mounting	8
2.4	Model 6517 connections	9
2.5	Model 6517B connections	9
2.6	Test voltage	11
2.7	Current measurement range and compliance limit	11
2.8	Electrification time	11
2.9	Resistivity measurement procedure	12

Section 3 — Derivation of Resistivity Equations

3.1	Introduction	13
3.2	Calculating resistivity	13
3.3	Resistivity nomographs	15
3.4	Derivation of resistivity equations	17

Section 4 — Maintenance

4.1	Introduction	21
4.2	Cleaning	21
4.3	Replaceable parts	21

List of Illustrations

Section 2 — Operation

Figure 2-1	Model 8009 resistivity test fixture	6
Figure 2-2	Model 8009 schematic diagram	7
Figure 2-3	Connecting the Model 6517 Electroemter/High Resistivity Meter to the Model 8009 test fixture	9
Figure 2-4	Connecting the Model 6517B Electroemter/High Resistivity Meter to the Model 8009 test fixture	10

Section 3 — Derivation of Resistivity Equations

Figure 3-1	Basic measurement techniques	13
Figure 3-2	Surface resistivity (σ) nomograph	15
Figure 3-3	Volume resistivity (ρ) nomograph	16
Figure 3-4	Electrode dimensions	19

List of Tables

Section 4 — Maintenance

Table 4-1	Model 8009 replaceable parts list	22
-----------	---	----

Blank page.

General Information

1.1 Introduction

This packing list contains information on using the Model 8009 Resistivity Test Fixture. The Model 8009 allows volume resistivity measurements up to 10^{18} ohm-cm or surface resistivity measurements up to $10^{17}\Omega$. The test fixture is designed using a three-lug triax connector that allows simple connection to a Keithley Instruments Model 6517, 6517A, or Model 6517B Electrometer.

NOTE

All references in this manual to the Keithley Instruments Model 6517 are also valid for the Model 6517A.

Model 8009 features

All electrodes made from stainless steel for corrosion prevention.

Switchable volume/surface resistivity modes.

Operates with Keithley Instruments Model 6517 and Model 6517B Electrometer/High Resistance Meters.

Safety interlock system and dual safety banana jacks for connection to 1kV source in Model 6517 and Model 6517B.

1.2 Supplied accessories

The following accessories are supplied with the Model 8009 test fixture:

- **Model 6517-ILC-3:** 3- meter, 4-pin interlock cable.
- **Model 6517B-ILC-3:** 3- meter, 4-pin interlock cable.
- **Model 7078-TRX-3:** A 3 ft. (0.9m) low noise triaxial cable that is

terminated at both ends with 3-slot triaxial connectors. Used to connect the Model 8009 test fixture to the Model 6517 Electrometer.

- **8007-GND-3:** Safety ground wire with ground lug.

1.3 Safety information

Safety symbols and terms

The following terms and symbols are found on the test equipment, or used in this packing list.

The  symbol on an instrument denotes the user should refer to the appropriate operating instructions.

The  symbol on an instrument denotes that 1000V or more may be present on the terminal(s). Use standard safety precautions to avoid personal contact with these voltages.

The **WARNING** heading indicates hazards that may cause personal injury or death. Always read over the information very carefully before performing the procedure.

The **CAUTION** heading explains hazards that could damage the instrument. Such damage may invalidate the warranty.

The ground screw  must be connected to a safety earth ground as explained in Section 2.

Safety precautions

WARNING

To avoid possible personal injury or death caused by electric shock, the following safety precautions must be observed when using the Model 8009 Resistivity Test Fixture.

1. Resistivity tests typically use lethal voltage levels. Safe operation requires the proper use of the lid interlock.
2. Before use, connect the test fixture screw terminal to a safety earth ground

using the Model 8007-GND-3 safety ground wire or #18 AWG (or larger) wire.

3. Do not exceed 1000V or 1A at the test fixture input triax connector.
4. Turn off the voltage source before connecting or disconnecting wires or cables in the test system.
5. Use the supplied triax cable and test leads to ensure that no conductive surfaces are exposed during the test.
6. After the test, set the voltage source to 0V and wait for the source to discharge before opening the lid of the test fixture.

NOTE

The Model 8009 Test Fixture includes a 10cm square, 1mm thick test sample. For maximum protection, the Model 8009 should always be stored with this sample between the electrodes.

Blank page.

2

Operation

2.1 Overview

The basic method used to determine resistivity of an insulator sample is a two step process; first, a test voltage is applied to the sample and the subsequent current is measured. Then the test voltage value and measured current value are applied to the appropriate equation, and resistivity is calculated.

The Model 8009 Resistivity Test Fixture is shown in Figure 2-1. The top view shows the inside of the test fixture where the sample is mounted. The front view shows the pushbutton switch that is used to select the desired resistivity test. The side view shows the test fixture connectors.

The schematic diagram of the Model 8009 Resistivity Test Fixture is shown in Figure 2-2. Notice that external connection to the electrodes of the test fixture is accomplished through a 3-lug female triax connector. This connector will mate directly to the Keithley Instruments Model 6517 using the Model 6517-ILC-3 cable or to a Model 6517B using the Model 6517B-ILC-3 cable.

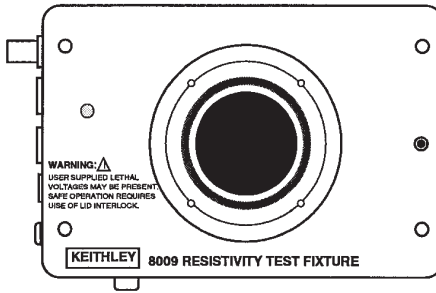

A. Top View (Sample Mounting)

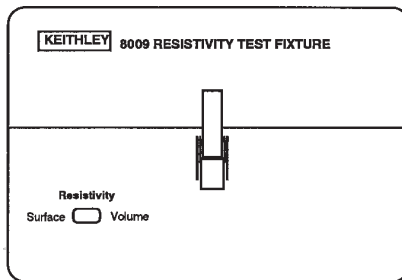

B. Front View (Resistivity Switch)

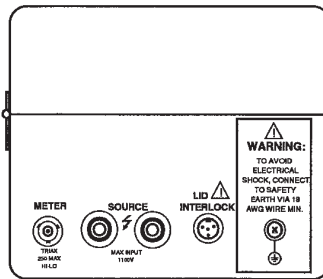

C. Side View (Connectors)

Figure 2-1
 Model 8009 resistivity test fixture

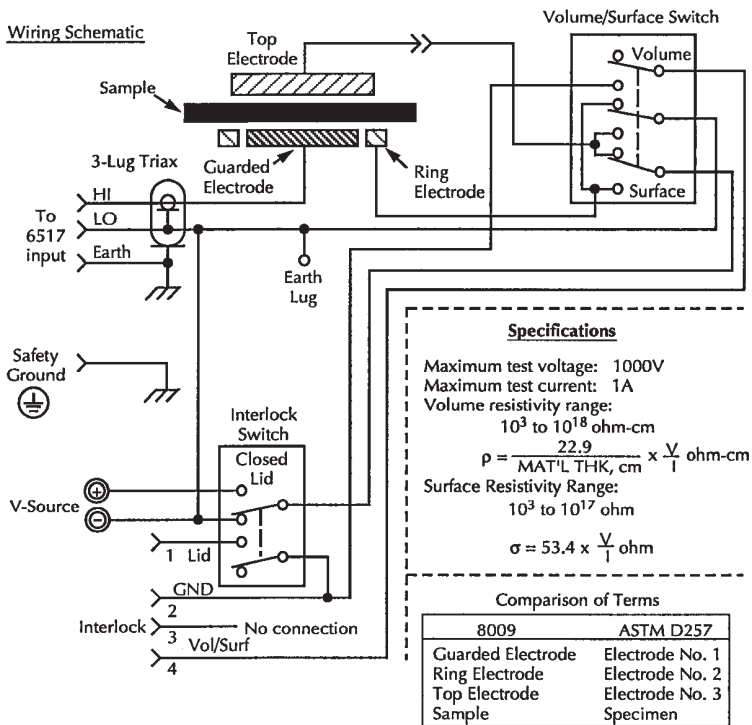

Figure 2-2
 Model 8009 schematic diagram

Models 6517 and 6517B Electrometer/High Resistance Meters

The Model 8009 Resistivity Fixture is designed to fully support the enhanced resistivity measurement capability of the Model 6517 and Model 6517B Electrometer/High Resistance Meters. Models 6517 and 6517B employ the ASTM D-257 measurement method, and display measurements in resistance, surface resistivity, or volume resistivity. All the Model 8009 electrode constants are programmed into Models 6517 and 6517B. A built-in high voltage source provides test voltages up to 1000 volts.

Models 6517 and 6517B offer special features for sophisticated, precise measurement of resistivity. Both models can automatically implement a “bias-measure” sequence in which the test voltage is applied for a programmed time to permit resistivity to reach equilibrium, after which the measurement can be made at some desired voltage. Models 6517 and 6517B can also measure and record

temperature and relative humidity using a type-K thermocouple (included with Model 6517), and the optional Model 6517-RH relative humidity probe.

The information presented in sections 2.2 through 2.8 covers all aspects of operation in detail. Section 2.9 integrates the operating information together to provide a short, but comprehensive procedure to make resistivity measurements. Section 3.3 provides resistivity nomographs that can be used to approximate resistivity.

2.2 ASTM standard

Methods, recommendations and calculations used in this manual to make resistivity measurements are based on the following ASTM Standard:

American Society for Testing and Materials, Standard Methods of Test for Electrical Resistance of Insulation Materials, ASTM Designation D257

2.3 Insulator sample mounting

The minimum and maximum sample sizes are listed in the specifications.

NOTE

Do not handle the insulator sample with bare fingers. Body oil will provide a conductive path and may corrupt the measurement. The use of acetate rayon gloves is recommended. For best results, clean the sample surfaces with an alcohol and ether mixture or other suitable solvent.

Perform the following steps to mount the insulator sample in the Model 8009:

1. The top electrode in the Model 8009 is permanently attached to the top cover. A test sample is provided with the Model 8009 to protect the electrodes (this sample can be used for a functional check of the Model 8009). Remove the test sample. When finished, reinstall the test sample to protect the electrode surfaces from nicks and scratches.
2. Center the insulator sample between the top and bottom electrodes of the Model 8009. Make sure there are no conductive paths between the electrodes other than those through the sample.
3. Close the lid of the test fixture and secure the latch.

2.4 Model 6517 Connections

Refer to Figure 2-3 to connect the Model 6517 to the Model 8009 test fixture. The triax cable and the Model 6517-ILC-3 interlock cable are supplied with the Model 8009. Note that the ground link on the Model 6517 must be removed. Proper grounding will be performed by the Model 8009.

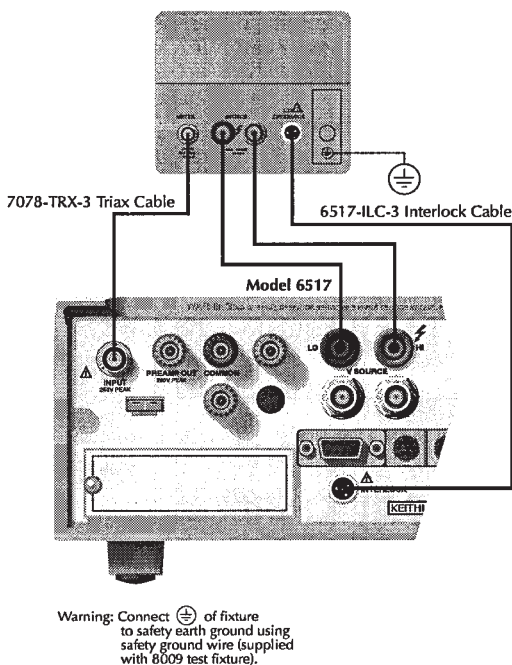
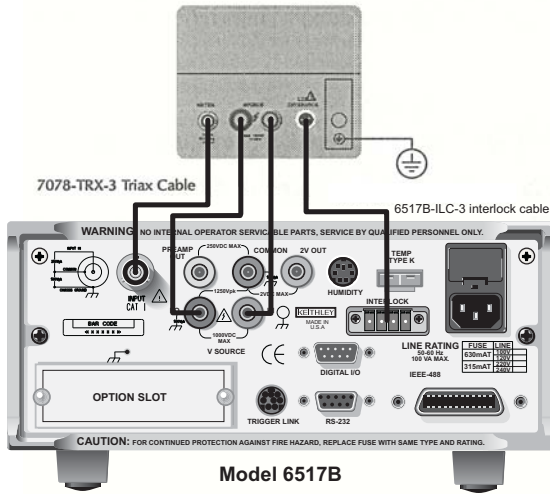

Figure 2-3

Connecting the Model 6517 Electrometer/High Resistivity Meter to the Model 8009 test fixture

2.5 Model 6517B Connections

Refer to Figure 2-4 to connect the Model 6517B to the Model 8009 test fixture. The triax cable and the 6517B-ILC-3 interlock cable are supplied with the Model 8009. Note that the ground link on the Model 6517B must be removed. Proper grounding will be performed by the Model 8009.



Warning: Connect \oplus of fixture to safety earth ground using safety ground wire (supplied with 8009 test fixture).

Figure 2-4

Connecting the Model 6517B Electrometer/High Resistivity Meter to the Model 8009 test fixture

Safety considerations

The earth ground screw terminal of the Model 8009 Resistivity Test Fixture must be connected to a known safety earth ground using the Model 8007-GND-3 ground wire, or #18 AWG or larger wire.

The use of hazardous voltage requires that interlock be used. The interlock circuit is activated when the Model 6517-ILC-3 or the Model 6517B-ILC-3 interlock cable (both supplied with the Model 8009) is connected as shown in Figures 2-3 and 2-4. Whenever the lid of the Model 8009 is open, the Model 6517 or Model 6517B will go into standby, thus removing power from the test fixture.

WARNING

To prevent electrical shock that could cause injury or death:

1. Put the Model 6517 or Model 6517B voltage source in **STANDBY** before opening the lid of the Model 8009.
2. Make sure the interlock cable is connected as shown in Figure 2-3 (Model 6517) or Figure 2-4 (Model 6517B).
3. Make sure the earth ground screw on the Model 8009 is connected to a known safety earth ground using the Model 8007-GND-3 or #18 AWG or larger wire.

2.6 Test voltage

Typically specified test voltages to be applied to the insulator sample are 100V, 250V, 500V and 1000V. Higher test voltages are sometimes used, however the maximum test voltage that may be applied to the Model 8009 is 1000V. The most frequently used test voltages are 100V and 500V. The Keithley Instruments Model 6517 can provide test voltages up to 1000V.

2.7 Current measurement range and compliance limit

To make the most accurate resistivity measurement, the Model 6517 must be on the most sensitive (optimum) current measurement range. The simplest way to achieve this is by placing the Model 6517 in autorange.

In general, a current compliance limit is to protect the device under test (DUT). For virtually all resistivity tests, protecting the insulator sample from excessive current is not a concern.

If manual ranging must be used, you may have to experiment to determine the best measurement range and subsequent compliance limit. For detailed information on compliance and measurement range selection, refer to the Model 6517 or Model 6517B Reference Manuals.

2.8 Electrification time

Electrification time is the total time that the specified voltage is applied to the insulator sample when the current measurement is taken. For example, for an electrification time of 60 seconds, the current measurement would be taken after the insulator sample was subjected to the applied voltage for 60 seconds. Keep in mind that experimentation may dictate a different electrification time. Unless otherwise specified, an electrification of 60 seconds is recommended.

2.9 Resistivity measurement procedure

The previously detailed operating information is integrated into the following procedure to make resistivity measurements.

WARNING

The following procedure uses hazardous voltage that could cause severe injury or death. Exercise extreme caution when the voltage source is in operate.

NOTE

To calculate volume resistivity, the average thickness of the sample must be known. If thickness is not known, use calipers to measure it. Calipers will provide a precise measurement.

1. Mount the insulator sample in the Model 8009 test fixture. See paragraph 2.3 for detailed information.
2. Close the lid of the test fixture, secure the latch and set the RESISTIVITY pushbutton switch for the desired test (SURFACE or VOLUME).
3. With power off, connect the test fixture as shown in Figure 2-3 (Model 6517) or Figure 2-4 (Model 6517B). See sections 2.4 and 2.5 for details.

WARNING

To prevent electrical shock that could cause injury or death, make sure that the interlock cable is properly connected and the Model 8009 earth ground screw is properly connected to a safety earth ground.

4. While in standby, set the voltage source to the appropriate test voltage. Typically, 500V is used as the test voltage for insulators.
5. While still in standby, set the Model 6517 or 6517B to an appropriate measurement range and current compliance limit. Autorange and a high compliance limit will suffice for most tests.
6. Place the voltage source in operate and after an appropriate electrification period, record the current reading from the display. Typically, an electrification period of 60 seconds is used.
7. Place the voltage source in standby.

3

Derivation of Resistivity Equations

3.1 Introduction

For instruments that do not directly measure resistivity, this section provides the equations needed to calculate volume and surface resistivity using the applied test voltage and the measured current. If accuracy is not needed, nomographs (see figures 3-2 and 3-3) can be used to approximate resistivity. This section also shows how to derive the equations used to calculate resistivity.

3.2 Calculating resistivity

The following equations used to calculate volume and surface resistivity are based on the physical dimensions of the electrodes of the Model 8009. Section 3.4, Derivation of Resistivity Equations, explains how these equations are derived.

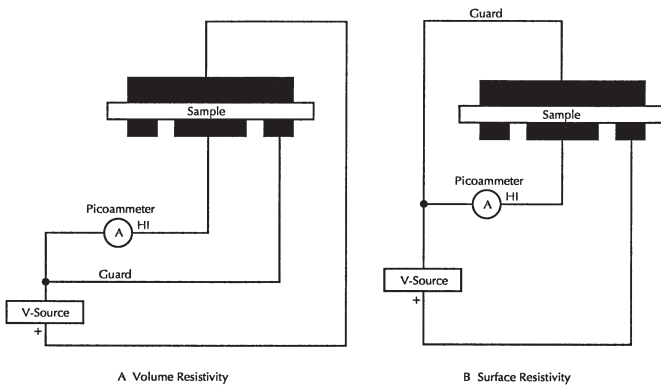

Figure 3-1
Basic measurement techniques

Volume Resistivity: Volume resistivity is defined as the electrical resistance through a one-centimeter cube of insulating material and is expressed in ohm-centimeters. Likewise, the electrical resistance through a one-inch cube of insulating material is expressed as ohm-inches.

Volume resistivity (ρ) is measured by applying a voltage potential across opposite sides of the insulator sample, measuring the resultant current through the sample (see Figure 3-1), and then performing one of the following calculations:

$$\rho = \frac{22.9V}{t_c I} \text{ ohm-centimeter}$$

or

$$\rho = \frac{3.55V}{t_i I} \text{ ohm-inches}$$

- Where: ρ is the volume resistivity of the sample.
 V is the applied voltage from the Electrometer.
 t_c is the average thickness of the sample in centimeters.
 t_i is the average thickness of the sample in inches.
 I is the current reading from the Electrometer.

Surface Resistivity: Surface resistivity is defined as the electrical resistance of the surface of an insulator material. It is measured from electrode to electrode along the surface of the insulator sample. Since surface length is fixed, the measurement is independent of the physical dimensions (for example, thickness and diameter) of the insulator sample.

Surface resistivity (σ) is measured by applying a voltage potential across the surface of the insulator sample, measuring the resultant current, and then performing the following calculation:

$$\sigma = \frac{53.4V}{I} \text{ ohms}$$

- Where: σ is the surface resistivity of the sample.
 V is the applied voltage from the Electrometer.
 I is the current reading from the Electrometer.

3.3 Resistivity nomographs

With test voltage and measured current (and sample thickness for volume resistivity) known, resistivity can be approximated by using the appropriate nomograph. Figure 3-2 shows the nomograph for surface resistivity and Figure 3-3 shows the nomograph for volume resistivity.

Surface Resistivity: The surface resistivity nomograph (Figure 3-2) is made up of three scales; voltage, resistivity and current. Perform the following steps to determine resistivity:

1. Plot the test voltage value on the voltage scale.
2. Plot the measure current value on the current scale.
3. Draw a straight line connecting the plotted voltage and current values.
4. Read the surface resistivity value (in ohms) from where the drawn line intersects the resistivity scale.

An example is shown in the graph. The dashed line connects a test voltage of 200V to a measured current of 3×10^{-10} amps (0.3nA). The dashed line intersects the resistivity scale at just under $4 \times 10^{13\frac{3}{4}}$ ($3.56 \times 10^{13\frac{3}{4}}$ by calculation).

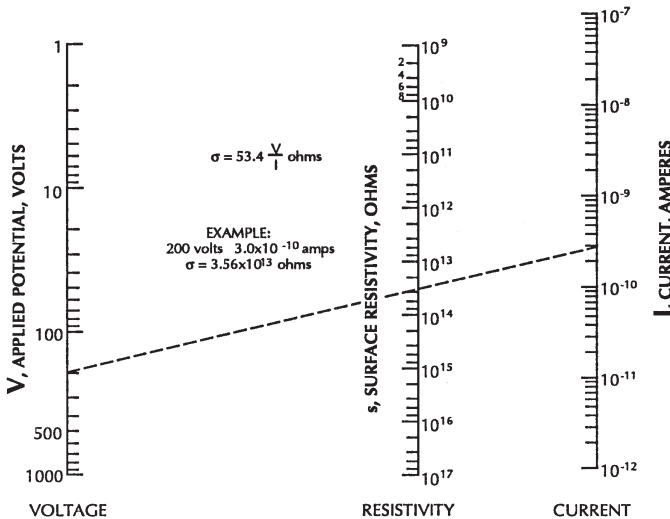

Figure 3-2
Surface resistivity (σ) nomograph

Volume Resistivity: The volume resistivity nomograph (Figure 3-3) is made up of four scales and a Graph Line. The four scales include; thickness (in cm) and current. Perform the following steps to determine volume resistivity:

1. Plot the average sample thickness (in cm) on the thickness scale.
2. Plot the test voltage value on the voltage scale.
3. Draw a straight line connecting the plotted thickness and voltage values. Note that this line will intersect the graph line.
4. Plot the measured current value on the current scale.
5. Draw a straight line from where the first line intersects the graph line to the plotted current value.
6. Read the volume resistivity value (in ohm-cm) from where the second line intersects the resistivity scale.

An example is shown on the graph. The first dashed line (a) connects a sample thickness of 0.15 cm to a test voltage of 200V. The second dashed line (b) connects the Graph Line intersection point to a measured current of 6×10^{-11} amps (60pA). The second dashed line (b) intersects the resistivity scale at approximately $5 \times 10^{14} \frac{1}{4}$ -cm ($5.09 \times 10^{14} \frac{1}{4}$ -cm by calculation).

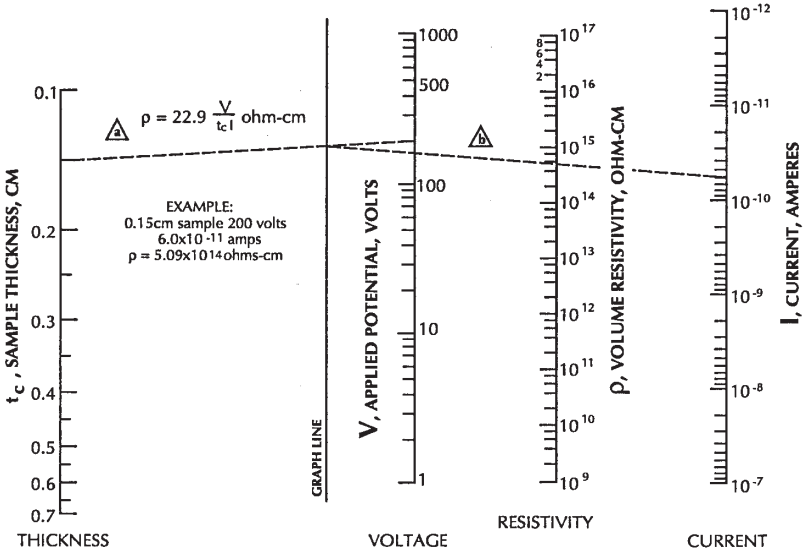

Figure 3-3
Volume resistivity (ρ) nomograph

3.4 Derivation of resistivity equations

The ASTM standard states that volume resistivity (ρ) shall be calculated as follows:

(Equation 1)

$$\rho = \frac{A}{t}R$$

Where: R is the volume resistance in ohms.
t is the average thickness of the sample.

A is the effective area of the guarded electrode for the particular electrode arrangement employed.

For the Model 8009, which uses circular electrodes, A is calculated as follows:

(Equation 2)

$$A = \frac{D^2}{4}\pi$$

Where: D_0 , which is the effective diameter of the guarded electrode (see figure 3-4), is 5.40 cm (2.125 in.). Thus,

$$A = \frac{(2.125)^2}{4}\pi = 3.55 \text{ square inches}$$

or

$$A = \frac{(5.40)^2}{4}\pi = 22.9 \text{ square centimeters}$$

By using the calculated values for A, volume resistivity (Equation 1) looks like this:

$$\rho = \frac{22.9}{t_c}R$$

or

$$\rho = \frac{3.55}{t_i}R$$

Where: t_c is the average thickness of the sample in centimeters.
 t_i is the average thickness of the sample in inches.

Volume resistance (R) is derived by dividing the applied test voltage (V) by the subsequent measured current (I). By substituting R with V/I, the following equations that are used in Section 2 to calculate volume resistivity are realized:

$$\rho = \frac{22.9V}{t_c I} \text{ ohm-centimeter}$$

or

$$\rho = \frac{3.55V}{t_i I} \text{ ohm-inches}$$

The ASTM standard states that surface resistivity (σ) shall be calculated as follows:

(Equation 3)

$$\sigma = \frac{P}{g}R$$

Where: R is the surface resistance in ohms.
g is 0.125 inches. This is the distance between the guarded electrode and the ring electrode (see Figure 3-4).
P is the effective perimeter of the guarded electrode for the particular electrode arrangement employed.

For the Model 8009, which uses circular electrodes, P is calculated as follows:

$$P = D_0\pi$$

Where: D_0 , which is the effective diameter of the guarded electrode (see Figure 3-1), is 2.125 inches. Thus,

$$P = 2.125\pi$$

By substituting the values for g and P into Equation 3, it then looks like this:Sur-

$$\sigma = \frac{2.125\pi}{0.125}R = 53.4R$$

face resistance (R) is derived by dividing the applied test voltage (V) by the subsequent measured current (I). By substituting R with V/I , the following equation that is used in Section 2 to calculate surface resistivity is realized:

$$\sigma = \frac{53.4V}{I} \text{ ohms}$$

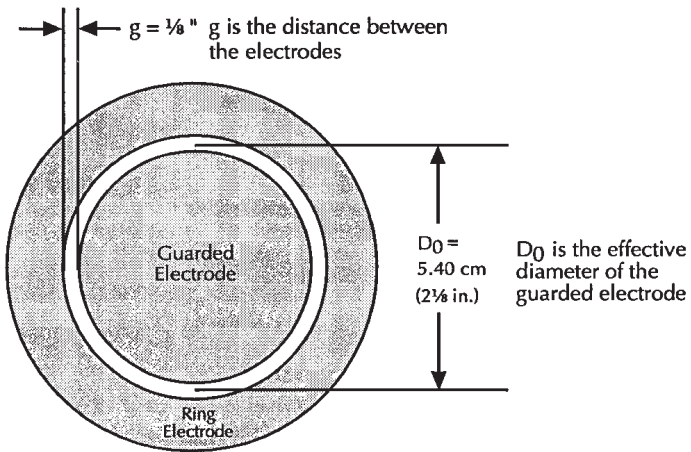

Figure 3-4
Electrode dimensions

Blank page.

4

Maintenance

4.1 Introduction

Normal maintenance for the Model 8009 consists of periodic cleaning of the electrodes and proper storage to keep the electrode surfaces from getting nicked and scratched. Also included in this section is a procedure to check out the operation of a test system, and a parts list.

4.2 Cleaning

The electrodes of the Model 8009 should be periodically cleaned with methanol or other suitable solvent. The connectors should also be kept clean to prevent leakage when measuring low level current.

When not in use, keep the supplied test sample installed between the electrodes. This will help prevent the surfaces of the electrodes from getting nicked and scratched.

4.3 Replaceable parts

Table 4-1 lists the replaceable parts that are available for the Model 8009. These parts can be obtained directly from Keithley Instruments, Inc. When ordering parts, be sure to indicate the Model number (8009), serial number, and the Keithley Instruments part number.

The unit can be returned for factory service, if desired. Call the Repair Department at 1-800-552-1115 for a Return Material Authorization (RMA) number. When returning the test fixture, write ATTENTION REPAIR DEPARTMENT on the shipping label, and be sure to advise as to the warranty status of the unit, as well as the type of service required.

Table 4-1*Model 8009 replaceable parts list*

Description	Keithley Instruments Part Number
ASSY, 3LUG TRIAX CABLE	7078-308-3C
BOTTOM PLATE	8009-302A
BUSHING	14782G
6517-ILC-3 CABLE ASSEMBLY	6517-330A
6517B-ILC-3 CABLE ASSEMBLY	CA-509A
CENTER ELECTRODE	8009-305A
COMPRESSION SPRING	SP-7-1
COND RUBBER CENTER	8009-307A
COND RUBBER TOP	8009-308A
CONNECTOR TRIAX	CS-630
CONNECTOR, 4-PIN MALE	CS-458
CONN, BANANA JACK BLK	BJ-12-0
CONN, BANANA JACK RED	BJ-12-2
DRAW LATCH	FA-261
FOOT, BLACK MOLDED POLY	FE-10
GROUND STRAP	8009-318B
HANDLE	HH-29
INSULATOR TEFLON	11647
PLATE BASE	8008-305B
POGO PIN	CS-833
PUSHBUTTON	29465-9C
RING ELECTRODE	8009-304A
SAMPLE	8009-317A
SILICONE ADHESIVE	CE-17
SPACER, NYLON	15712B
SPACER PLATE	8009-309A
SPRING, LEAF	8009-310A
SWITCH	SW-493
SWITCH, DOOR INTERLOCK	SW-486
TEST BOX	8009-301B
TOP PLATE	8009-303A
TOP WEIGHTED ELECTRODE	8009-306A

Service Form

Model No. _____ Serial No. _____ Date _____

Name and Telephone No. _____

Company _____

List all control settings, describe problem and check boxes that apply to problem.

-
-
- | | |
|---|--|
| <input type="checkbox"/> Intermittent | <input type="checkbox"/> Analog output follows display |
| <input type="checkbox"/> Particular range or function bad; specify: _____ | |
| <input type="checkbox"/> IEEE failure | <input type="checkbox"/> Obvious problem on power-up |
| <input type="checkbox"/> Batteries and fuses are OK | <input type="checkbox"/> Front panel operational |
| <input type="checkbox"/> All ranges or functions are bad | <input type="checkbox"/> Checked all cables |

Display or output (check one)

- | | |
|---|--|
| <input type="checkbox"/> Drifts | <input type="checkbox"/> Unable to zero |
| <input type="checkbox"/> Unstable | <input type="checkbox"/> Will not read applied input |
| <input type="checkbox"/> Overload | <input type="checkbox"/> Calibration only |
| <input type="checkbox"/> Calibration certificate required | <input type="checkbox"/> Data required |

(attach any additional sheets as necessary)

Show a block diagram of your measurement system including all instruments connected (whether power is turned on or not). Also, describe signal source.

Where is the measurement being performed (factory, controlled laboratory, outdoors)?

What power line voltage is used: _____ Ambient temperature: _____ °F

Relative humidity: _____ Other: _____

Any additional information (if special modifications have been made by the user, please describe). _____

Be sure to include your name and phone number on this service form.

KEITHLEY

Keithley Instruments, Inc.

28775 Aurora Road • Cleveland, Ohio 44139

440-248-0400 • Fax: 440-248-6168

1-888-KEITHLEY (534-8453)

www.keithley.com

Printed in the U.S.A.