



**PA3000
Power Analyzer
User Manual**



077-1152-01



**PA3000
Power Analyzer
User Manual**

Copyright © Tektronix. All rights reserved. Licensed software products are owned by Tektronix or its subsidiaries or suppliers, and are protected by national copyright laws and international treaty provisions.

Tektronix products are covered by U.S. and foreign patents, issued and pending. Information in this publication supersedes that in all previously published material. Specifications and price change privileges reserved.

TEKTRONIX and TEK are registered trademarks of Tektronix, Inc.

Contacting Tektronix

Tektronix, Inc.
14150 SW Karl Braun Drive
P.O. Box 500
Beaverton, OR 97077
USA

For product information, sales, service, and technical support:

- In North America, call 1-800-833-9200.
- Worldwide, visit www.tek.com to find contacts in your area.

Warranty

Tektronix warrants that this product will be free from defects in materials and workmanship for a period of three (3) years from the date of shipment. If any such product proves defective during this warranty period, Tektronix, at its option, either will repair the defective product without charge for parts and labor, or will provide a replacement in exchange for the defective product. Parts, modules and replacement products used by Tektronix for warranty work may be new or reconditioned to like new performance. All replaced parts, modules and products become the property of Tektronix.

In order to obtain service under this warranty, Customer must notify Tektronix of the defect before the expiration of the warranty period and make suitable arrangements for the performance of service. Customer shall be responsible for packaging and shipping the defective product to the service center designated by Tektronix, with shipping charges prepaid. Tektronix shall pay for the return of the product to Customer if the shipment is to a location within the country in which the Tektronix service center is located. Customer shall be responsible for paying all shipping charges, duties, taxes, and any other charges for products returned to any other locations.

This warranty shall not apply to any defect, failure or damage caused by improper use or improper or inadequate maintenance and care. Tektronix shall not be obligated to furnish service under this warranty a) to repair damage resulting from attempts by personnel other than Tektronix representatives to install, repair or service the product; b) to repair damage resulting from improper use or connection to incompatible equipment; c) to repair any damage or malfunction caused by the use of non-Tektronix supplies; or d) to service a product that has been modified or integrated with other products when the effect of such modification or integration increases the time or difficulty of servicing the product.

THIS WARRANTY IS GIVEN BY TEKTRONIX WITH RESPECT TO THE PRODUCT IN LIEU OF ANY OTHER WARRANTIES, EXPRESS OR IMPLIED. TEKTRONIX AND ITS VENDORS DISCLAIM ANY IMPLIED WARRANTIES OF MERCHANTABILITY OR FITNESS FOR A PARTICULAR PURPOSE. TEKTRONIX' RESPONSIBILITY TO REPAIR OR REPLACE DEFECTIVE PRODUCTS IS THE SOLE AND EXCLUSIVE REMEDY PROVIDED TO THE CUSTOMER FOR BREACH OF THIS WARRANTY. TEKTRONIX AND ITS VENDORS WILL NOT BE LIABLE FOR ANY INDIRECT, SPECIAL, INCIDENTAL, OR CONSEQUENTIAL DAMAGES IRRESPECTIVE OF WHETHER TEKTRONIX OR THE VENDOR HAS ADVANCE NOTICE OF THE POSSIBILITY OF SUCH DAMAGES.

[W4 – 15AUG04]

Table of Contents

Important safety information	vii
General safety summary	vii
Service safety summary	x
Terms in this manual	xi
Symbols and terms on the product	xi
Compliance information	xii
EMC compliance	xii
Safety compliance	xiii
Environmental considerations	xv
Preface	xvii
Features and abilities	xvii
Getting started	1
Before you begin - safety	1
Power on	2
Concept of global, group, and channel parameters	3
Connecting to the product under test	4
Results screen	6
Navigating the Results screen	7
Navigating the menu system	8
On-screen help	9
Front panel	11
Front panel controls and connectors	11
Quick view keys	12
Results screen	13
Waveform screen	14
Bar chart screen	15
Integrator screen	17
Vector screen	19
Math screen	20
Setup screen	21
Front panel USB port	22
Soft keys	23
Menu and Help keys	24
Operational and alphabetical keys	24
Number and formula keys	25
Logging data to a storage device	26
Connecting signals	28
Input overview	28
To connect a simple current transformer	30

To connect an external resistive shunt.....	31
To connect a transducer with a voltage output.....	33
To connect a voltage transformer / transducer.....	34
Power for external transducers	35
The menu system	36
Measurements	36
Measurement Configuration menu.....	38
Modes	42
Inputs.....	47
Graphs and waveforms.....	53
Interfaces	54
Datalog.....	56
Math results	56
System Configuration	59
User Configuration	61
Remote operation.....	62
Overview	62
Interfacing with RS-232 systems.....	62
Interfacing with USB systems.....	62
Interfacing with Ethernet systems.....	62
Interfacing with GPIB systems (optional)	63
Status reporting	63
Command listing.....	66
IEEE 488.2 standard commands and status commands	67
Channel and group commands	69
Unit information commands.....	70
Measurement selection and reading commands.....	70
Measurement configuration commands	74
Mode setup commands.....	79
Input setup commands	83
Graph and waveform commands.....	88
Interface commands	89
Datalog commands	90
Screen save commands.....	91
Math commands	91
System configuration commands.....	92
User configuration commands.....	95
Sending and receiving commands	96
Communications examples	97
PA3000 software.....	100
PWRVIEW PC software	100

Firmware update utility	101
Application examples	103
Example 1: Efficiency testing single phase applications	104
Example 2: Efficiency testing three phase applications	112
Example 3: Energy consumption testing	121
Example 4: Standby power measurements (IEC 62301 Ed. 2.0).....	127
Example 5: Inrush current testing.....	133
Reference information	139
Measured parameters	139
Accuracy equations	141
Sum equations.....	142
Communication ports.....	146
Index	

List of Figures

Figure i: Tektronix PA3000 Power Analyzer.....	xvii
Figure 1: Typical PA3000 input connections.....	4
Figure 2: Rear panel input module.....	5
Figure 3: Result screen (four-channel instrument).....	6
Figure 4: Left and right arrow hard keys.....	7
Figure 5: Front panel controls and connectors.....	11
Figure 6: Quick view keys.....	12
Figure 7: Results screen.....	13
Figure 8: Waveform screen.....	14
Figure 9: Bar chart screen.....	15
Figure 10: Integrator screen.....	17
Figure 11: Vector screen.....	19
Figure 12: Math screen.....	20
Figure 13: Setup screen (first screen).....	21
Figure 14: Setup screen (second screen).....	22
Figure 15: Operational and alphabet keys.....	24
Figure 16: Example data file.....	27
Figure 17: Signal inputs on rear panel (Channel 1 shown).....	28
Figure 18: Current transformer connections.....	30
Figure 19: External resistive shunt connections.....	31
Figure 20: Current transformer connections.....	34
Figure 21: External resistive shunt connections.....	35
Figure 22: Measurements screen.....	36
Figure 23: Example of a moved measurement.....	38
Figure 24: Measurement Configuration menu.....	38
Figure 25: Single-phase, two-wire and DC measurements. Select 1 phase, 2 wire.....	47
Figure 26: Single-phase, three-wire. Select 1 phase, 3 wire.....	48
Figure 27: Three-phase, three-wire (2 Wattmeter method). Select 3 phase, 3 wire.....	48
Figure 28: Three phase, three wire (3 Wattmeter method). Select 3 phase, 3 wire (3V3A).....	48
Figure 29: Three-phase, three-wire (3 Wattmeter method). Select 3 phase, 4 wire.....	49
Figure 30: Three-phase, four-wire (3 Wattmeter method). Select 3 phase, 4 wire.....	49
Figure 31: Status byte.....	63
Figure 32: Status byte register.....	64
Figure 33: Display Data Status Register.....	64
Figure 34: Display Data Status Enable Register.....	64
Figure 35: Standard Event Status Register.....	65
Figure 36: Standard Event Status Enable Register.....	65
Figure 37: PWRVIEW software.....	100

Figure 38: AC-DC efficiency measurement wiring diagram	105
Figure 39: Efficiency measurement on the PA3000	105
Figure 40: Harmonic bar chart on the PA3000.....	108
Figure 41: Efficiency measurement with the PWRVIEW software.....	108
Figure 42: Efficiency Trend Chart.....	110
Figure 43: Logging setup.....	111
Figure 44: Custom limits setup	112
Figure 45: PWM motor drive efficiency (1 phase in and 3 phase out)	114
Figure 46: Vector graph on the PA3000.....	116
Figure 47: PWM Motor drive efficiency (3 phase in and 3 phase out).....	117
Figure 48: Auxiliary inputs setup for torque and speed measurements	119
Figure 49: Harmonic bar chart	120
Figure 50: Energy consumption measurements wiring diagram	122
Figure 51: Energy consumption testing on the PA3000.....	123
Figure 52: Integration Trend chart.....	126
Figure 53: Custom Limits	127
Figure 54: Standby power measurements wiring diagram.....	128
Figure 55: Standby Power mode.....	129
Figure 56: Full compliance IEC 62301 Standby power test	130
Figure 57: IEC 62301 Ed. 2.0 Standby power test report.....	132
Figure 58: Inrush current measurement wiring diagram	134
Figure 59: Min-Max columns for the Inrush current measurement.....	135
Figure 60: Inrush current measurement.....	136
Figure 61: Power analyzer communication ports on the rear panel.....	147

List of Tables

Table 1: Front panel controls and connectors	11
Table 2: Signal inputs on rear panel.....	28
Table 3: Weighing factors for TIF	41
Table 4: Effects of frequency range settings in PWM mode.....	46
Table 5: Input ranges.....	50
Table 6: Valid channel parameters.....	57
Table 7: Valid group parameters	58
Table 8: Valid group sum parameters	58
Table 9: Parameters for returning values from the analog and counter inputs.....	58
Table 10: Status byte register bit definitions	64
Table 11: Display data status register bit definitions	64
Table 12: Display data status enable register bit definitions.....	64
Table 13: Standard event status register bit definitions.....	65
Table 14: Standard event status enable register bit definitions	65
Table 15: Phase measurements.....	139
Table 16: Measurement accuracy.....	141
Table 17: One phase, three wire sum equations.....	142
Table 18: Three phase, three wire sum equations.....	143
Table 19: Three phase, four wire sum equations.....	144
Table 20: USB connector pin descriptions.....	146
Table 21: Communication ports on the rear panel	147
Table 22: Ethernet pin descriptions.....	148
Table 23: GPIB port pin configuration descriptions	148
Table 24: Auxiliary input-output pin descriptions	149
Table 25: RS-232 connector pin descriptions	149

Important safety information

This manual contains information and warnings that must be followed by the user for safe operation and to keep the product in a safe condition.

To safely perform service on this product, additional information is provided at the end of this section. (See page x, *Service safety summary*.)

General safety summary

Use the product only as specified. Review the following safety precautions to avoid injury and prevent damage to this product or any products connected to it. Carefully read all instructions. Retain these instructions for future reference.

Comply with local and national safety codes.

For correct and safe operation of the product, it is essential that you follow generally accepted safety procedures in addition to the safety precautions specified in this manual.

The product is designed to be used by trained personnel only.

Only qualified personnel who are aware of the hazards involved should remove the cover for repair, maintenance, or adjustment.

Before use, always check the product with a known source to be sure it is operating correctly.

This product is not intended for detection of hazardous voltages.

Use personal protective equipment to prevent shock and arc blast injury where hazardous live conductors are exposed.

While using this product, you may need to access other parts of a larger system. Read the safety sections of the other component manuals for warnings and cautions related to operating the system.

When incorporating this equipment into a system, the safety of that system is the responsibility of the assembler of the system.

To avoid fire or personal injury

Use proper power cord. Use only the power cord specified for this product and certified for the country of use.

Do not use the provided power cord for other products.

Use proper voltage setting. Before applying power, make sure that the line selector is in the proper position for the source being used.

Ground the product. This product is grounded through the grounding conductor of the power cord. To avoid electric shock, the grounding conductor must be

connected to earth ground. Before making connections to the input or output terminals of the product, make sure that the product is properly grounded.

Do not disable the power cord grounding connection.

Power disconnect. The power cord disconnects the product from the power source. See instructions for the location. Do not position the equipment so that it is difficult to operate the power cord; it must remain accessible to the user at all times to allow for quick disconnection if needed.

Connect and disconnect properly. Do not connect or disconnect probes or test leads while they are connected to a voltage source.

Use only insulated voltage probes, test leads, and adapters supplied with the product, or indicated by Tektronix to be suitable for the product.

Observe all terminal ratings. To avoid fire or shock hazard, observe all ratings and markings on the product. Consult the product manual for further ratings information before making connections to the product. Do not exceed the Measurement Category (CAT) rating and voltage or current rating of the lowest rated individual component of a product, probe, or accessory. Use caution when using 1:1 test leads because the probe tip voltage is directly transmitted to the product.

Do not apply a potential to any terminal, including the common terminal, that exceeds the maximum rating of that terminal.

Do not float the common terminal above the rated voltage for that terminal.

The measuring terminals on this product are not rated for connection to Category III, or IV circuits.

Do not operate without covers. Do not operate this product with covers or panels removed, or with the case open. Hazardous voltage exposure is possible.

Avoid exposed circuitry. Do not touch exposed connections and components when power is present.

Do not operate with suspected failures. If you suspect that there is damage to this product, have it inspected by qualified service personnel.

Disable the product if it is damaged. Do not use the product if it is damaged or operates incorrectly. If in doubt about safety of the product, turn it off and disconnect the power cord. Clearly mark the product to prevent its further operation.

Before use, inspect voltage probes, test leads, and accessories for mechanical damage and replace when damaged. Do not use probes or test leads if they are damaged, if there is exposed metal, or if a wear indicator shows.

Examine the exterior of the product before you use it. Look for cracks or missing pieces.

Use only specified replacement parts.

Replace batteries properly. Replace batteries only with the specified type and rating.

Recharge batteries properly. Recharge batteries for the recommended charge cycle only.

Use proper fuse. Use only the fuse type and rating specified for this product.

Wear eye protection. Wear eye protection if exposure to high-intensity rays or laser radiation exists.

Do not operate in wet/damp conditions. Be aware that condensation may occur if a unit is moved from a cold to a warm environment.

Do not operate in an explosive atmosphere.

Keep product surfaces clean and dry. Remove the input signals before you clean the product.

Provide proper ventilation. Refer to the installation instructions in the manual for details on installing the product so it has proper ventilation.

Slots and openings are provided for ventilation and should never be covered or otherwise obstructed. Do not push objects into any of the openings.

Provide a safe working environment. Always place the product in a location convenient for viewing the display and indicators.

Avoid improper or prolonged use of keyboards, pointers, and button pads. Improper or prolonged keyboard or pointer use may result in serious injury.

Be sure your work area meets applicable ergonomic standards. Consult with an ergonomics professional to avoid stress injuries.

Use care when lifting and carrying the product. This product is provided with handles for lifting and carrying.

Use only the Tektronix rackmount hardware specified for this product.

Probes and test leads

Before connecting probes or test leads, connect the power cord from the power connector to a properly grounded power outlet.

Keep fingers behind the finger guards on the probes.

Remove all probes, test leads and accessories that are not in use.

Use only correct Measurement Category (CAT), voltage, temperature, altitude, and amperage rated probes, test leads, and adapters for any measurement.



WARNING. *To prevent electrical shock, do not exceed the maximum measurement or maximum floating voltage for the test lead.*

Connect and disconnect properly. Connect the test leads to the measurement product before connecting it to the circuit under test. Connect the reference test lead to the circuit under test before connecting the test lead input. Disconnect the test lead input and the reference test lead from the circuit under test before disconnecting the test leads from the measurement product.

Connect and disconnect properly. De-energize the circuit under test before connecting or disconnecting the test leads.

Do not connect a test lead to any circuit that carries voltages above the voltage rating of the test lead.

Inspect the test leads and accessories. Before each use, inspect test leads and accessories for damage (cuts, tears, or defects in the test lead body, accessories, or cable jacket). Do not use if damaged.

Floating measurement use. Do not float the reference lead above the rated float voltage.

Service safety summary

The *Service safety summary* section contains additional information required to safely perform service on the product. Only qualified personnel should perform service procedures. Read this *Service safety summary* and the *General safety summary* before performing any service procedures.

To avoid electric shock. Do not touch exposed connections.

Do not service alone. Do not perform internal service or adjustments of this product unless another person capable of rendering first aid and resuscitation is present.

Disconnect power. To avoid electric shock, switch off the product power and disconnect the power cord from the mains power before removing any covers or panels, or opening the case for servicing.

Use care when servicing with power on. Dangerous voltages or currents may exist in this product. Disconnect power, remove battery (if applicable), and disconnect test leads before removing protective panels, soldering, or replacing components.

Verify safety after repair. Always recheck ground continuity and mains dielectric strength after performing a repair.

Terms in this manual

These terms may appear in this manual:



WARNING. *Warning statements identify conditions or practices that could result in injury or loss of life.*



CAUTION. *Caution statements identify conditions or practices that could result in damage to this product or other property.*

Symbols and terms on the product

These terms may appear on the product:

- DANGER indicates an injury hazard immediately accessible as you read the marking.
- WARNING indicates an injury hazard not immediately accessible as you read the marking.
- CAUTION indicates a hazard to property including the product.



When this symbol is marked on the product, be sure to consult the manual to find out the nature of the potential hazards and any actions which have to be taken to avoid them. (This symbol may also be used to refer the user to ratings in the manual.)

The following symbol(s) may appear on the product:

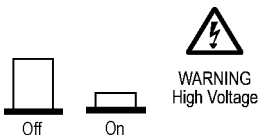

Compliance information

This section lists the EMC (electromagnetic compliance), safety, and environmental standards with which the instrument complies.

EMC compliance

EC Declaration of Conformity – EMC

Meets intent of Directive for Electromagnetic Compatibility. Compliance was demonstrated to the following specifications as listed in the Official Journal of the European Communities:

EN 61326-1, EN 61326-2-1. EMC requirements for electrical equipment for measurement, control, and laboratory use. ^{1 2 3 4}

- CISPR 11. Radiated and conducted emissions, Group 1, Class A
- IEC 61000-4-2. Electrostatic discharge immunity
- IEC 61000-4-3. RF electromagnetic field immunity
- IEC 61000-4-4. Electrical fast transient/burst immunity
- IEC 61000-4-5. Power line surge immunity
- IEC 61000-4-6. Conducted RF immunity
- IEC 61000-4-11. Voltage dips and interruptions immunity

EN 61000-3-2. AC power line harmonic emissions

EN 61000-3-3. Voltage changes, fluctuations, and flicker

Mfr. Compliance Contact.

Tektronix, Inc. PO Box 500, MS 19-045
Beaverton, OR 97077, USA
www.tek.com

- ¹ This product is intended for use in nonresidential areas only. Use in residential areas may cause electromagnetic interference.
- ² Emissions which exceed the levels required by this standard may occur when this equipment is connected to a test object.
- ³ Equipment may not meet the immunity requirements of applicable listed standards when test leads and/or test probes are connected due to coupling of electromagnetic interference onto those leads/probes. To minimize the influence of electromagnetic interference, minimize the loop area between the unshielded portions of signal and associated return leads, and keep leads as far away as possible from electromagnetic disturbance sources. Twisting unshielded test leads together is an effective way to reduce loop area. For probes, keep the ground return lead as short as possible and close to the probe body. Some probes have accessory probe tip adapters to accomplish this most effectively. In all cases, observe all safety instructions for the probes or leads used.
- ⁴ For compliance with the EMC standards listed here, high quality shielded interface cables should be used.

**Australia / New Zealand
Declaration of
Conformity – EMC**

Complies with the EMC provision of the Radiocommunications Act per the following standard, in accordance with ACMA:

- CISPR 11. Radiated and Conducted Emissions, Group 1, Class A, in accordance with EN 61326-1.

Safety compliance

This section lists the safety standards with which the product complies and other safety compliance information.

**EU declaration of
conformity – low voltage**

Compliance was demonstrated to the following specification as listed in the Official Journal of the European Union:

Low Voltage Directive

- EN 61010-1. Safety Requirements for Electrical Equipment for Measurement, Control, and Laboratory Use – Part 1: General Requirements.
- EN 61010-2-030. Safety Requirements for Electrical Equipment for Measurement, Control, and Laboratory Use – Part 2-030: Particular requirements for testing and measuring circuits.

Equipment type

Test and measuring equipment.

Safety class

Class 1 – grounded product.

**Pollution degree
descriptions**

A measure of the contaminants that could occur in the environment around and within a product. Typically the internal environment inside a product is considered to be the same as the external. Products should be used only in the environment for which they are rated.

- Pollution degree 1. No pollution or only dry, nonconductive pollution occurs. Products in this category are generally encapsulated, hermetically sealed, or located in clean rooms.
- Pollution degree 2. Normally only dry, nonconductive pollution occurs. Occasionally a temporary conductivity that is caused by condensation must be expected. This location is a typical office/home environment. Temporary condensation occurs only when the product is out of service.
- Pollution degree 3. Conductive pollution, or dry, nonconductive pollution that becomes conductive due to condensation. These are sheltered locations

where neither temperature nor humidity is controlled. The area is protected from direct sunshine, rain, or direct wind.

- Pollution degree 4. Pollution that generates persistent conductivity through conductive dust, rain, or snow. Typical outdoor locations.

Pollution degree rating Pollution degree 2 (as defined in IEC 61010-1). Rated for indoor, dry location use only.

IP rating IP20 (as defined in IEC 60529).

Measurement and overvoltage category descriptions Measurement terminals on this product may be rated for measuring mains voltages from one or more of the following categories (see specific ratings marked on the product and in the manual).

- Category II. Circuits directly connected to the building wiring at utilization points (socket outlets and similar points).
- Category III. In the building wiring and distribution system.
- Category IV. At the source of the electrical supply to the building.

NOTE. Only mains power supply circuits have an overvoltage category rating. Only measurement circuits have a measurement category rating. Other circuits within the product do not have either rating.

Mains overvoltage category rating Overvoltage category II (as defined in IEC 61010-1).

Environmental considerations

This section provides information about the environmental impact of the product.

Product end-of-life handling

Observe the following guidelines when recycling an instrument or component:

Equipment recycling. Production of this equipment required the extraction and use of natural resources. The equipment may contain substances that could be harmful to the environment or human health if improperly handled at the product's end of life. To avoid release of such substances into the environment and to reduce the use of natural resources, we encourage you to recycle this product in an appropriate system that will ensure that most of the materials are reused or recycled appropriately.



This symbol indicates that this product complies with the applicable European Union requirements according to Directives 2012/19/EU and 2006/66/EC on waste electrical and electronic equipment (WEEE) and batteries. For information about recycling options, check the Support/Service section of the Tektronix Web site (www.tek.com).

Preface

Features and abilities

The Tektronix PA3000 is a powerful and versatile precision power analyzer. Designed to provide clear and accurate measurements of electrical power and energy on all electrical products, the PA3000 is both an easy to use bench instrument and a fast and programmable automatic test interface.

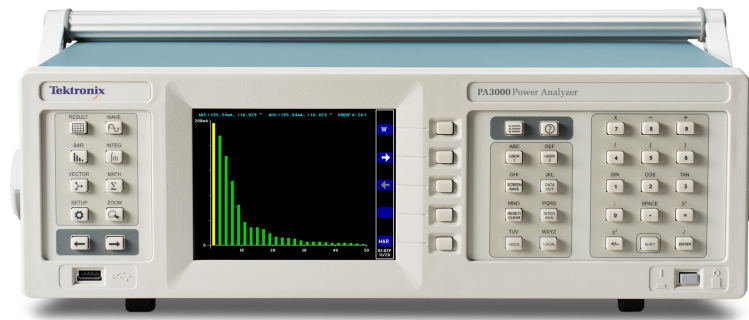

Figure i: Tektronix PA3000 Power Analyzer

Some of the basic features are listed below:

- Measures watts, volts, amps, volt-amperes and power factor; always accurate, even on distorted waveforms
- 100 harmonics for voltage, current, and watts as standard
- One to four channels for multiphase measurements
- Quick access to results, graphing and menus
- Built in 30 A and 1 A shunt
- Range of measurement from milliwatts to megawatts
- Bright color display
- Comprehensive range of computer interfaces including RS-232, USB, GPIB (optional), and Ethernet
- Data logging to an attached USB flash drive
- ± 15 V supply for external transducers
- Easy-to-use menu system with context-sensitive help
- Built in math screen where any result can be manipulated and displayed. Ideal for measurements such as efficiency

Getting started

Before you begin - safety

Carefully read and adhere to the following warning statements before you connect the power analyzer.



WARNING. *To avoid possible electric shock or personal injury please be aware of the following items:*

By connecting the power analyzer to active circuits, the terminals and certain parts inside the power analyzer are live.

If possible, open the circuit before establishing a connection to the power analyzer.

Before connecting the circuits, ensure that the maximum measuring voltage and maximum voltage to earth ground ($600 V_{rms}$, CAT II) is not exceeded.

Do not use leads and accessories that do not comply with relevant safety standards, as this could lead to serious injury or death from electric shock.

Shunts and conductors can generate heat when in use and surfaces can burn the skin.

Qualified personnel

This product is intended to be operated by qualified personnel only. This means only persons who are familiar with the installation, assembly, connection, inspection of connections, and operation of the power analyzer and who have been trained in the following areas:

- Switching on/off, enabling, earth-grounding and identification of electrical circuits and services/systems according to the applicable safety standards
- Maintenance and operation of appropriate safety gear, in accordance with the applicable safety standards
- First aid

Ensure that all persons using the device have read and fully understood the user manual and safety instructions.

Installation

- Mains connection must conform to these ranges/values: 100 – 240 V, 50/60 Hz.
- The device can only be used under certain ambient conditions. Ensure that the actual ambient conditions conform to the admissible conditions specified in this manual.
- Ensure this product is installed in such a way that its power cable is accessible at all times and can easily be disconnected.

- Before each use**
- Ensure that the power and connecting cables as well as all accessories and connected devices used in conjunction with this product are in proper working order and clean.
 - Ensure that any third-party accessories used in conjunction with the device conform to the applicable IEC 61010-031 / IEC 61010-2-032 standards and are suitable for the respective measuring voltage range.

Connection sequence



WARNING. *To avoid possible electric shock or personal injury, when the measuring circuit is used to measure MAINS, the voltage to earth must not exceed 600 V_{rms} in a CAT II environment.*

For safety reasons, when connecting a circuit to the power analyzer, proceed in the sequence outlined as follows:

1. Connect the instrument power cord to a properly grounded mains outlet.
The power analyzer is now connected to the protective earth ground wire.
2. Power on the instrument.
3. Connect the measuring circuit according to all instructions and as shown in the connection diagrams in this manual.

- During use**
- For connecting cables and instruments, work in teams of at least two people.
 - If you detect any damage to the housing, controls, power cable, connecting leads, or connected devices, immediately disconnect the unit from the power supply.
 - If you are in doubt as regards the safe operation of the device, immediately shut down the unit and the respective accessories, secure them against inadvertent switching on, and have them serviced by a qualified service person.

Power on

1. Check that the power analyzer is in good condition with no signs of damage.
2. Follow the Connection Sequence described in the *Before you begin - safety* section. (See page 1.)
3. Press the power switch to turn on the power analyzer.

The instrument will start the power on sequence; this takes approximately 15 seconds. During power on you will see the serial number and firmware version of the instrument.

4. The instrument is now ready for use.

Concept of global, group, and channel parameters

Definition of a group

With a multiphase power analyzer there is often a requirement to link together measurement channels. This is known as grouping. Within a group, one channel will act as the frequency source and reference for all other channels in the group. Grouping is commonly used in applications such as three phase motor measurements. Channels 1 and 2 can be grouped together to allow for the measurement of the input power, where Channels 3 and 4 could be grouped together to measure the output power. For more information on applying grouping to channels, see the *Wiring* section of *The Menu System* chapter. (See page 47, *Wiring*.)

Global, group, and channel settings

The PA3000 has many different settings that affect both the appearance of the results and the actual results. To make the instrument easier to operate, settings might have an effect on one or more parameters. Depending on the parameter, the influence or use of it might be on a global level, a per-group level or a per-channel level. The split for parameters that have an effect on measurements and results is defined below.

Global settings

Global settings affect all measurements. The following settings are global:

- Blanking (See page 59, *Blanking*.)
- Averaging (See page 59, *Averaging*.)
- Update rate (See page 60, *Update rate*.)
- Autozero (See page 60, *Autozero*.)

Global settings will appear under the System Configuration menu.

Groups settings

Per-group settings affect every channel in a group. The settings affected are:

- Measurements (See page 36, *Measurements*.)
- Measurement configuration (See page 38, *Measurement Configuration menu*.)
- Mode (See page 42, *Modes*.)
- Wiring (See page 47, *Wiring*.)
- Ranges (See page 50, *Ranging*.)
- Shunt selection (See page 51, *Shunts*.)

- Frequency source (See page 51, *Frequency Source*.)
- Bandwidth (See page 52, *Bandwidth*.)

Channel settings

Channel settings are completely independent of any grouping. The following settings are on a per-channel basis:

- Scaling factor (See page 52, *Scaling*.)

When setting a parameter that is a per-group or per-channel parameter, the group or channel will be displayed at the top of the menu. To change the group or channel, use the left and right arrow hard keys.

Connecting to the product under test

The PA3000 will measure up to 600 V_{rms}, CAT II and 30 A_{rms} or 1 A_{rms} directly using the 4 mm terminals on the rear of each analog card. For measurements outside the range (low or high power), see the information on using current and voltage transducers. (See page 28, *Connecting signals*.)

To measure power, connect the measuring terminals of the PA3000 in parallel with the supply voltage and in series with the load current as shown in the following figure.



WARNING. Using improper or damaged safety cables can result in serious injury or death from electrical shock. To avoid injury always use good quality safety cables as supplied and verify that they are not damaged before use.

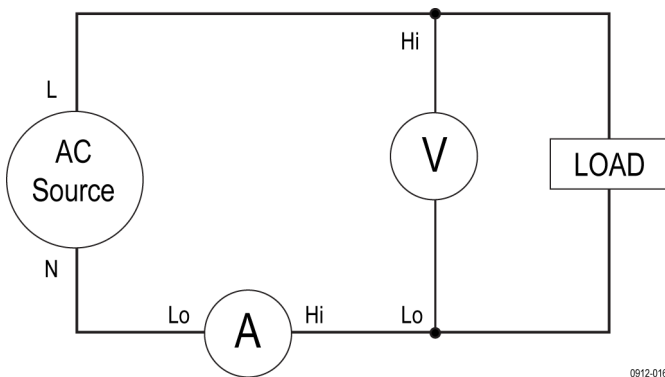

Figure 1: Typical PA3000 input connections

Refer to the following figure while connecting the cables to the rear panel input module on the PA3000.

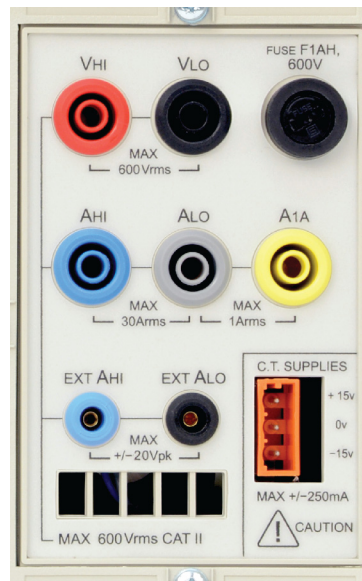

Figure 2: Rear panel input module

- Connect the AC supply live to the **VHI** terminal.
- Connect the AC supply neutral to the **VLO** terminal.
- Connect the load neutral to either the 30 A **AHI** or 1 A **A1A** terminal.
- Connect the supply neutral to the **ALO** terminal.

For plug-connected single phase products, the simplest and safest way to make a connection to the product under test is to use a Tektronix Break Out Box. This provides a line socket for connection of the product and 4 x 4 mm sockets for direct connection to the PA3000 terminals as described above.

Turn on the supply to the load and the power analyzer is now ready to take measurements. Note that it is not necessary to power off or power on the instrument on when connecting the load.

Results screen

The Results screen displays after the instrument completes the power-on sequence. The following figure shows the Results screen.

GROUP A Ch1		GROUP B Ch2		GROUP C Ch3		GROUP D Ch4		Result 33406
Vrms	118.79	V	Vrms	0.0000	V	Vrms	0.0000	V
Arms	0.0000	A	Arms	0.0000	A	Arms	0.0000	A
Watt	0.0000	W	Watt	0.0000	W	Watt	0.0000	W
VA	0.0000	VA	VA	0.0000	VA	VA	0.0000	VA
Freq	59.975	Hz	Freq	0.0000	Hz	Freq	0.0000	Hz
PF	0.0000	PF	PF	0.0000	PF	PF	0.0000	
								06:45P 02/08

Figure 3: Result screen (four-channel instrument)





Depending on the number of channels in your instrument, the Results screen shows up to four columns of results (one per channel). The display can be broken down into columns and rows. Each column is one of four colors representing the results for that group. There can be many different columns within a group. In a single-phase application, there can only be one column of results per group. If the minimum and maximum hold columns were added, then this would expand the number of columns to three.

Within a group, the result name is listed in the group color on the left of the group. All the results with the group are always shown in the same order. The results are shown on separate rows.

In default mode, each column represents one channel of the instrument, and each channel is contained with a different group. Each group is configured as a wiring setup, for example: 1 phase, 2 wire. Each row shows the measurement type **Vrms**, the measured value, **248.4** and the measurement units, **V**. Normal engineering notation is used to describe units, mV = millivolts (10e-3) and MV = megavolts (10e+6).

Navigating the Results screen

On the right side of most screens is a column of soft keys. Use these keys to navigate through the displayed screen or to access other screens or menus. The soft keys are displayed on the menus, but are controlled by the front panel keys to the right of the display.

	Page up
	Scroll up one measurement row
	Scroll down one measurement row
	Page down

To view the results in a larger size, press  (ZOOM key on the left front panel). The screen will cycle through four different zoom levels, which are:

- Four columns of 12 results per column
- Two columns of six results per column
- One column of three results per column
- Four columns of nine results with six math results

If there are more columns than can be displayed on the screen (for example: six columns of results in four-column mode), use the left and right arrow hard keys to scroll to those columns.





Figure 4: Left and right arrow hard keys

The PA3000 has the option of fixed or auto ranging. Default is auto range. If you choose a fixed range, or the peak of the input signal is larger than the range, then an over range condition will occur. This will be indicated on the results screen by all the results in the over ranged channel flashing on and off. In addition, the “Vrms” and / or “Arms” will flash to indicate whether the over range is on either the voltage channel, the current channel, or both.

Navigating the menu system

The menu system provides complete access to all settings of the PA3000. To access the menu system, press the  (MENUS key).

To return to the measurement display at any time, simply press  again or press  (RESULT key).







With the menu system active, the five soft keys to the right of the display can be used to navigate and select options. A list of the menu keys can be found in the soft key section of the manual. (See page 23, *Soft keys*.)

If the menu you are in displays a group or channel name, this means that the setting is only for the displayed group or channel. To move to another group or channel, use the left and right arrow hard keys.



Example: Choosing measurements to display

One of the first tasks to carry out is to change the list of displayed measurements.

To choose the measurements on the display:

1. Press  (to show the menu).
2. Press  to see the list of Measurements. Measurements with a check mark will be displayed in the order shown.
3. Use the  and  keys to select a measurement to display and press  to enable it to be displayed.
4. To change the order in which a measurement is displayed, first select the measurement you want to move and then press .

The selection bar will turn red.



5. Use  and  to move the measurement and then press  to accept the new position.



To remove a selected measurement, select it and press .

To restore the default list, see the User Configuration Menu. (See page 61, *User Configuration*.)

NOTE. Depending on the mode selected, some measurements will not be selectable. (See page 42, *Modes*.) More details on selecting measurements are available. (See page 36, *Measurements*.)

On-screen help

Throughout the menu system, on-screen help is available to provide summarized help on the subject at hand. For example, press  and then press the  (HELP) key; help on the Main Menu will be displayed. Press  again to remove the help and return back to the previous screen.

As you select menu options and need help on a particular screen, press  to get a brief summary of help on that subject. Help does not exist on every screen and at every level; if you press  without any help showing then there is no help available at this level.

Front panel

Front panel controls and connectors

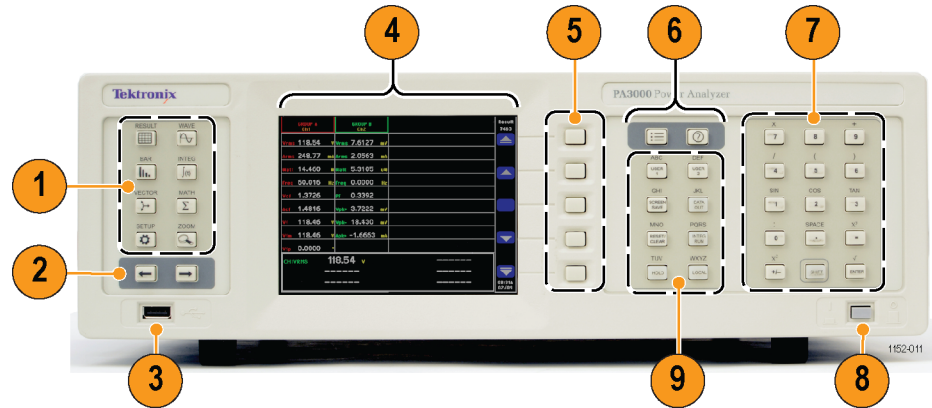

Figure 5: Front panel controls and connectors

Table 1: Front panel controls and connectors

1	Quick view keys
2	Left and right arrow hard keys
3	USB connection for flash drives
4	640 x 480 TFT display
5	Soft keys
6	Menu and Help keys
7	Number and formula keys
8	Front mounted on / off switch
9	Operational and alphabet keys







Quick view keys

The Quick view keys provide easy access to different display screens.



Figure 6: Quick view keys

The first seven keys change the display screen to show different information:

-  (RESULT key) displays the normal Results screen.
-  (WAVE key) displays waveforms.
-  (BAR key) displays a harmonics bar chart.
-  (INTEG key) displays integrator waveforms when in Integrator mode.
-  (VECTOR key) displays a vector diagram.
-  (MATH key) displays the math results as configured from the math menu.
-  (SETUP key) displays a screen showing the current instrument configuration.

Press any one of these keys to change to the appropriate display. Pressing the same key again has no effect.

At the bottom there is a ZOOM key () and left and right arrow hard keys.

The ZOOM key changes the number of results displayed on the screen. It will go from four columns, to two columns, to one column, and then to four columns with math results at the bottom. Pressing again will return the display to four columns.

Waveform screen

Press  to display the Waveform screen. This screen shows waveforms of the measured data in continuous operating mode.

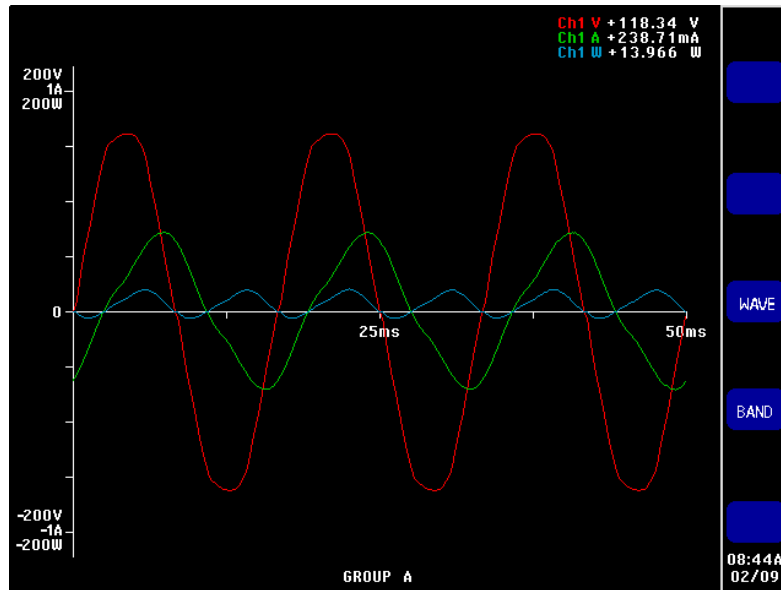



Figure 8: Waveform screen

The Waveform screen consists of two sections. At the top right of the display are the volts, amps and watts values for each of the channels in the group. The label for the channel is color coded to match the waveform. (See page 53, *Graphs and waveforms*.) Measurements are displayed even if the waveform is not.

Below these measurements is the actual waveform which is plotted out against the X and Y axes.

Select the waveforms to view by pressing , selecting **Graphs and Waveforms**, and then **Waveform** followed by the actual selection of volts, amps, or watts to display as a waveform. You can also press  as a shortcut to quickly access the Select Waveforms menu.

Waveform selection is done on a per-group basis. Only signals within a specified group can be displayed on the same waveform graph.

Changing the group is done by using the left and right arrow hard keys at the bottom left of the display. This changes the group of and the waveforms displayed.

When drawing a waveform, the phase reference signal for the group is started at the intersection of the X and Y axes. Choosing to display or not display the reference waveform will not affect the position of the other waveforms. For example, if Channel 1 volts was the phase reference and Channel 1 amps was 90 degrees lagging, but Channel 1 volts was not displayed, then Channel 1 amps would still start at 90 degrees lagging.

For the X (time) axis, the range will be twice the period of the lowest frequency signal being displayed, rounded up to time starting with 1, 2 or 5. For example, if 50 Hz is the lowest frequency, then twice the period would be 40 ms, and 50 ms would be the time base. If there is no frequency measured on any of the displayed waveforms (all DC), then 500 ms will be used for the time base.

For the Y axis the range for all the displayed channels of the same units (volts, amps, or watts) is examined. The maximum range is the range used.

Bar chart screen

Press  to display the Bar chart screen. The Bar chart screen displays either volts, amps or watts harmonic information in the form of a bar chart.

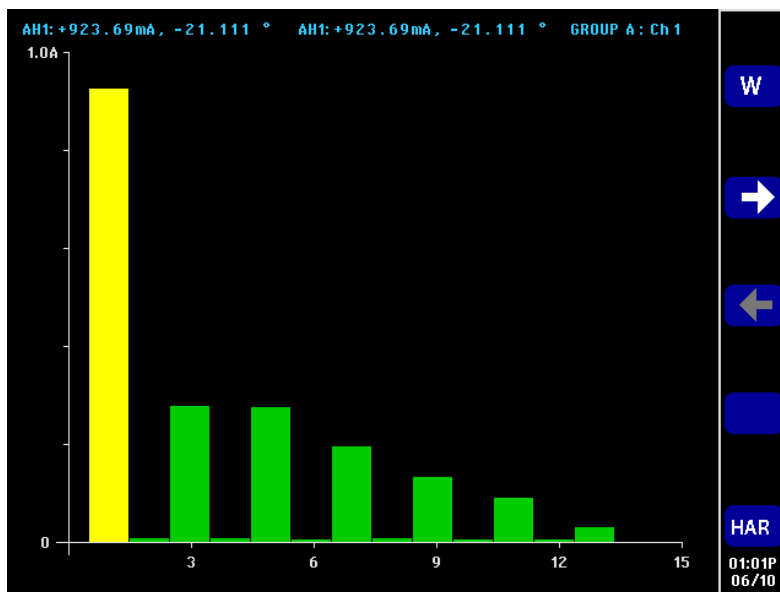

Figure 9: Bar chart screen

The data used for the display is based on the harmonics setup for the group in which the channel is in. All soft key actions are on a per-group basis. The left and right arrow hard keys are used to change channel.

Harmonics do not need to be displayed as results for the bar chart to show harmonics. If harmonics are never displayed, and never configured, then the bar chart would be based on the default harmonic setup.





At the top of each graph are two readings and group and channel name. The first reading is the fundamental value, in the measured units, and phase angle. The second result is the highlighted harmonic in the same units as it would be displayed on the results screen (either percentage or absolute as defined by the users setting for the group) and the phase angle. The phase angle will be displayed irrespective of whether it is displayed on the results screen.

An individual harmonic can be selected by using the left and right arrow soft keys. The selected harmonic will be yellow as opposed to green. The left and right arrows will only change the selection of the harmonic with the active group. If the display is only showing one bar chart, then using the selection is straightforward. When the user then changes to the next channel using the left and right arrow hard keys, the harmonic selected will be based on possible changes when viewing the previous channel.

For the X axis, the maximum number of harmonic values that can be displayed is 50, even though there could be up to 100. The harmonic values displayed are determined by the harmonic sequence and range for the appropriate group. For example, if the unit has been configured to display odd and even harmonics up to the 50th, then 50 harmonics will be displayed. If only odd harmonics up to the 19th, then 10 harmonics will be displayed.

If the number of harmonics to be displayed is less than 50, then they will be spread across the allowed width of the graph. If the user has selected more than 50 harmonics to display, then the left and right arrow soft keys will be used to scroll through the harmonics and the axis labels will be changed after the 50th harmonic result has been reached.

A summary of the soft keys is detailed below:

	Toggles the harmonics displayed between volts, amps, and then watts, returning back to volts. Works on a per-group basis.
	Changes the harmonic selected by one to the right (higher order).
	Changes the harmonic selected by one to the left (lower order).
	Jumps to the harmonics setup menu.

Integrator screen

Press  to display the Integrator screen. The Integrator screen allows you to display integrated results on a graph when in Integrator mode. (See page 43, *Integrator mode*.)

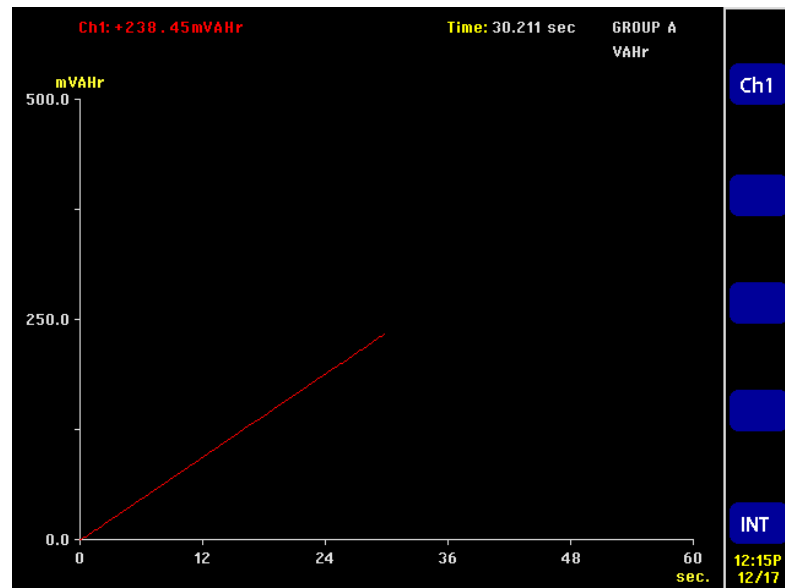

Figure 10: Integrator screen

One of the following results can be displayed at any one time:

- Watt Hours
- VA Hours
- VAr Hours
- Amp Hours
- Watts Average
- PF Average
- Volts
- Amps
- Watts
- Fundamental VA-Hours (VAHf)
- Fundamental VAr-Hours (VArHf)
- Correction VARs

As with the integrator itself, the results are displayed on a group-by-group basis. This means that the maximum number of plot lines is four, which will occur in a 3p4w system with sum results. There is the option of adding or removing plot lines from the display within the constraints of the group. For example, you could select to see the Channel 1 result and the Sum result.

There are two reasons for allowing this selection:

- In a balanced three-phase system, the integrated readings for each channel will be very similar and so the plot lines will be overlaid one on top of the other. This could lead to confusion.
- Again in a balanced three phase system, if a channel and the sum results are displayed on the same graph, the channel plot will never come higher up the Y axis than 1/3 way, at best. Removing the sum result and rescaling the Y axis allows better resolution for the channel plot.

At the top of the display is a reading for each channel in the group (including the Sum channel). The reading is for the same result as is selected in the integrator waveform setup screen to display on the screen, for example, if the plot is WHrs, then the reading is WHrs.

The plot is always in the same color as the channel designator.

At any time while the integration graph is being displayed, pressing the left or right arrow hard keys will change to group results. If only one group is in integrator mode, then graph will not change.

Both the X and Y axes are automatically scaled. For the Y axis, the time will change automatically as the integration time increases. This allows for the best viewing of the graph.

Any time during integration, you change the plots by pressing the **INT** soft key. This takes you directly to the integrator waveform setup menu with the appropriate group selected.

Vector screen

Press  to display the Vector screen. The Vector screen displays one of volts, amps, or volts and amps harmonic information in the form of a vector diagram.

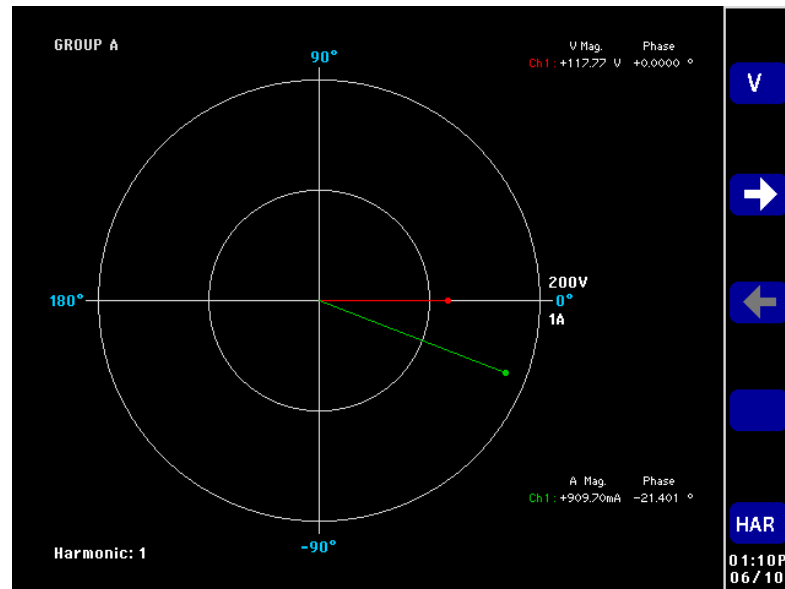

Figure 11: Vector screen

Vectors will be displayed on a per-group basis. The left and right arrow hard keys change the currently displayed group. The active group is displayed in the top left corner in the appropriate group color.

The left and the right soft keys change the harmonic number currently being displayed. The harmonics available for display will be the same as the harmonics in the results screen. There are two differences. The first is that if the results screen is configured to display magnitudes as a percentage of the fundamental, the absolute magnitude will still be used. This will allow a true comparison between the magnitudes of the selected harmonic for each channel in the group. The second is that if the user has not enabled harmonics to display, then the harmonic setup will still be used. This provides a quick way to view harmonic information without displaying harmonics.





The V/A top soft key toggles the display between displaying volts vectors only, amps vectors only, and both volts and amps vectors.

Each vector displayed is shown in a different color. There can be up to six vectors displayed on the graph at one time. This would be a for a 3p4w configuration showing volts and amps.

In addition to displaying a vector line, the magnitude and phase angle of the vector are displayed to the right of the vector diagram. Both the voltage and current information is shown even if the vector is not.

The magnitude is based on the maximum range for the group being displayed (in auto range channels can be on different ranges). The ranges will not change when the harmonic number is changed, allowing a visual comparison between harmonic numbers.

A summary of the soft keys is detailed below:

	Toggles the vectors displayed between volts only, amps only, and volt and amps together. Works on a per-group basis.
	Changes the harmonic vector displayed by one to the right (higher order). Works on a per-group basis.
	Changes the harmonic vector displayed by one to the left (lower order). Works on a per-group basis.
	Jumps to the harmonics setup menu. Jumps to the appropriate group.

Math screen

Press  to display the Math screen. The Math screen displays user configured values. These can be a selection of desired values displayed on one easy-to-read screen, or basic measurements mathematically manipulated to show a required a value.

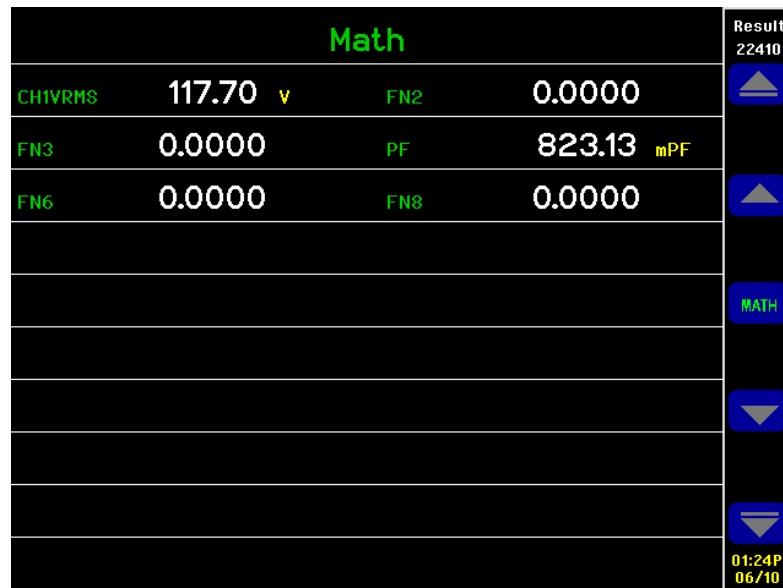





Figure 12: Math screen

Up to 30 math functions, labelled FN1 through FN30, can be defined. For each function the following can be specified:

- **Name.** User friendly name up to ten characters. (Default is the same as the label, for example, FN1). In the menus, the function label is always displayed alongside the users name for the function.
- **Units.** User friendly units such as W for watts. (Default is blank). Prefixes such as u, m, k, M will be added to the unit as appropriate. Units will be up to four characters.
- **Function.** The actual math formula, up to 100 characters.

Additional information can be found under the Math results. (See page 56.)

Setup screen

Press  to access the Setup screens. The first screen displays the current configuration of the channels and groups, and items such as blanking and remote control settings. Press  or  to view information at the bottom of the screen.

Analyzer Configuration				
	Channel 1	Channel 2	Channel 3	Channel 4
V Scaling	1.000	1.000	1.000	1.000
I Scaling	1.000	1.000	1.000	1.000
Ext.Shunt Scal.	1.000	1.000	1.000	1.000
V Ext.Phase Comp.	0.000	0.000	0.000	0.000
I Ext.Phase Comp.	0.000	0.000	0.000	0.000
V Range	5 V	5 V	5 V	200 V
I Range	12.5 mA	500 mA	500 mA	500 mA
	GROUP A	GROUP B	GROUP C	GROUP D
Wiring	1Ph2W	1Ph2W	1Ph2W	1Ph2W
Mode	Integrator	Normal	Normal	Normal
V Range	Auto	Auto	Auto	Auto
I Range	Auto	Auto	Auto	Auto
Shunt	Internal 1 A	Internal 30 A	Internal 30 A	Internal 30 A
Freq. Source	Volts	Volts	Volts	Volts
Phase Ref.	Volts	Volts	Volts	Volts
Freq. Range	>10 Hz	>10 Hz	>10 Hz	>10 Hz
Bandwidth	High	High	High	High

05:37P
01/22

Press -> for instruments information

Figure 13: Setup screen (first screen)

Access the second screen by pressing the right arrow hard key at bottom, left side of the front panel. This screen shows instrument configuration including information, such as when the unit was last verified and last adjusted, the serial number of the unit and the firmware version, and information on the installed analog cards.

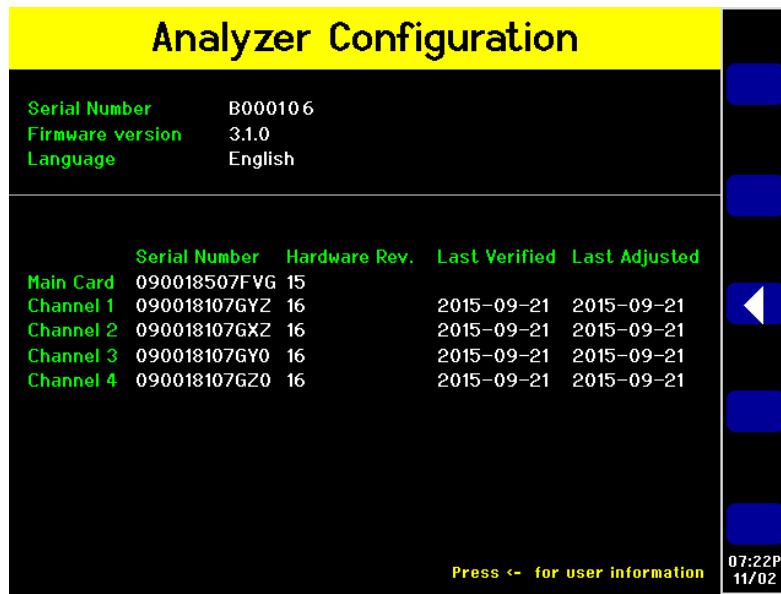

Figure 14: Setup screen (second screen)

Front panel USB port

Use the front panel USB port with an attached USB flash drive to capture screens or to collect data for use on another device.

When you connect the flash drive to the USB port, the LED under the DATA OUT key momentarily turns on.

When you press the SCREEN SAVE key, the instrument performs a screen capture and saves the screen to the flash drive. The LED under the DATA OUT key turns on while the screen is saved to the flash drive.

When you press the DATA OUT key, the instrument logs the measurement data to a file on the flash drive; the LED under the key blinks while the instrument logs the data. Press the key again to stop the data logging.

For additional information on the front panel USB port refer to the discussion under Communication ports, later in this document. (See page 146, *Front panel USB host port*.)



Soft keys

Soft keys provide context-sensitive functionality. Common soft key images provide common functionality. The common soft keys are shown below. If the symbol on the key is gray, the limit has been reached. Details on the specialized soft keys are in the appropriate section of this manual.

	Page up
	Move up one result / menu line / help text line.
	No functionality
	Move down one result / menu line / help text line.
	Page down
	Go to the previous menu.
	Go to the next menu.
	Move the selected measurement up or down in the list.
	Move selected measurement up one row
	Move selected measurement down one row.
	Select highlighted item.
	Cancel
	Apply value.
	Delete one character to the left of the cursor.
	Clear the text entry.

Menu and Help keys

The Menu and Help keys are located above the operational and alphabet keys to the right of the display.

-  Toggles the on screen menus on and off. The menu will always come on at the top level.
-  Toggles on screen help that is context sensitive based on the current display. Pressing any other key, other than configured soft keys, when help is displayed, will have no effect. Press  again to close the help screen.

Operational and alphabetical keys

To the right of the soft keys are the operational keys, which also function as a way of entering alphabetical characters.



Figure 15: Operational and alphabet keys

- USER 1 / ABC, USER 2 / DEF. These keys provide quick access to a set menu. Pressing and holding either of these keys for 2 seconds while displaying a menu will link the menu to the pressed key. For example, if you press and hold USER 1 while the Voltage range menu is showing, then press USER 1 while any other screen is showing, the Voltage range menu displays.
- SCREEN SAVE / GHI. Press this key to perform a screen capture and to save the screen to a compatible flash drive connected to the front panel USB port. The screen is saved as a bit mapped file in a PA3000 folder on the flash drive. The file name is automatically assigned by the instrument, such as SCREEN01.BMP; if the name already exists, the instrument increments the

number to avoid overwriting an existing file. The LED under the DATA OUT key turns on while the data is written to the flash drive.

- DATA OUT / JKL. Press this key to start or stop a data log. If data is being logged, then this key will flash.
- RESET/CLEAR / MNO. The function of this key depends on the configuration of the instrument. It can clear minimum / maximum hold results and reset the integrator.
- INTEG RUN / PQRS. Press this key to start or stop the integrator. If the integrator is running, then this key will be on.
- HOLD / TUV. Press this key to stop updating the results on the screen. Pressing again lets the results change. If the display is held, then the LED under the HOLD key will be on. If the integrator is running, the values will still be accumulating.
- LOCAL / WXYZ. Any time the instrument receives communications via USB, GPIB, Ethernet, or RS-232, the front panel will be locked out. Press the LOCAL key to return control to the front panel. When the front panel is locked out, the LED under the LOCAL key will be on.

To enter alphabetical characters, press the SHIFT key, located under the Number and formula keys. The LED under the SHIFT key turns on. Each time the same alphabetical character key is pressed the letter being entered changes in the order shown above the key. If the key is not pressed for one second, or a different key is pressed, the cursor will move to the next position.

Number and formula keys

The main purpose of the numeric section of the keypad is for numeric and formula entry. The keys are as follows:

- 7 / x. Number seven or, with SHIFT, multiply
- 8 / -. Number eight or, with SHIFT, subtract
- 9 / +. Number nine or, with SHIFT, add
- 4 / /. Number four or, with SHIFT, divide
- 5 / (. Number five or, with SHIFT, left parentheses
- 6 /). Number six or, with SHIFT, right parentheses
- 1 / SIN. Number one or, with SHIFT, sine function
- 2 / COS. Number two or, with SHIFT, cosine function
- 3 / TAN. Number three or, with SHIFT, tangent function
- 0 / :. Number zero or, with SHIFT, a colon)

- . / SPACE. Decimal point or, with SHIFT, space
- = / x^y . Equals or, with SHIFT, X to the power Y
- +/- / x^2 . positive or negative or, with SHIFT, X squared
- SHIFT. Press this key to enter alternate functions on the keypad.
- ENTER / $\sqrt{\quad}$. Enter or, with SHIFT, square root.

Logging data to a storage device

The PA3000 can log data to a USB flash drive. The unit will log all selected measurements into a comma separated value (.csv) formatted file that is stored on the connected USB flash drive. Results will be logged at the rate specified in the USB Host Data Out menu (the default rate is every 0.5 seconds).

Prior to enabling data logging, insert a USB flash drive into the USB host port on the front of the PA3000. The rear port cannot be used for USB flash drives.

Logging data

To start data logging press the DATA OUT key. The LED under the key flashes indicating the data is logging. To stop data logging, press the DATA OUT key. When the LED stops flashing, the USB flash drive is safe to remove.

Data storage and format

The data will be logged in a directory created by the PA3000 on the USB flash drive. The directory structure created will contain the last five digits of the serial number of the PA3000 used and the date at the start of data logging. The file name will reflect the time at the start of data logging in 24-hour clock format and will have a .csv extension.

For example, if a PA3000 with serial number 100010210134 begins data logging on 31 March 2016 at 2:18:56 PM, the directory tree will be as shown below.

```
\PA3000\10134\16-03-31\14-18-56.csv
```

The first portion of the file will contain a header identifying the instrument used by serial number and the time data logging began.

The second portion will contain information on the group configuration of the PA3000. It will contain the group index, the name of the group, the number of channels in the group, and the number of results returned for the group.

The third portion of the file will contain column headers for every measurement currently selected. Subsequent columns will contain an indexed set of the measurements currently selected, in the order displayed on the PA3000 screen. An example of the data returned is shown in the following figure.

	A	B	C	D	E	F	G	H
1	Tektronix PA3000							
2	Serial Nur B010134							
3	Firmware 3.1.0							
4	Start Date	3/15/2016						
5	Start Time	14:18:56 AM						
6								
7	Group	Name	# of Ch.	# of Res.	Wiring			
8	1	GROUP A	1	59	1Ph2W			
9	2	GROUP B	1	0	1Ph2W			
10								
11	# Math Re	6						
12								
13								
14	Index	Time	Vrms(1)	Arms(1)	Watt(1)	Freq(1)	PF(1)	Vcf(1)
15	1	11:56:24	1.19E+02	1.02E+00	1.00E+02	6.00E+01	8.25E-01	1.38E+01
16	2	11:56:25	1.19E+02	1.03E+00	1.01E+02	6.00E+01	8.26E-01	1.38E+01
17	3	11:56:25	1.19E+02	1.03E+00	1.01E+02	6.00E+01	8.28E-01	1.38E+01
18	4	11:56:26	1.19E+02	1.03E+00	1.01E+02	6.00E+01	8.27E-01	1.38E+01
19	5	11:56:26	1.18E+02	1.03E+00	1.00E+02	6.00E+01	8.25E-01	1.38E+01
20	6	11:56:27	1.18E+02	1.03E+00	1.00E+02	6.00E+01	8.26E-01	1.38E+01
21	7	11:56:27	1.18E+02	1.02E+00	1.00E+02	6.00E+01	8.25E-01	1.38E+01
22	8	11:56:28	1.18E+02	1.03E+00	1.00E+02	6.00E+01	8.24E-01	1.38E+01
23	9	11:56:28	1.18E+02	1.03E+00	1.00E+02	6.00E+01	8.25E-01	1.38E+01

Figure 16: Example data file

Math results are also returned when data logging. These will be after the channel results. Only enabled math results will be returned. The column name will consist of the function name and the units specified by the user.

Additional information on the front panel USB port and the USB flash drive requirements is available later in this document. (See page 146, *Front panel USB host port.*)

Connecting signals

Input overview



WARNING. To avoid possible electric shock or personal injury:

Do not touch connections, internal circuits, or measuring devices that are not connected to earth ground.

Always adhere to the instructions regarding the sequence of connections. (See page 2, Connection sequence.)

Signals are connected to the instrument on the rear of the power analyzer. There are multiple inputs for each analog card as shown below.

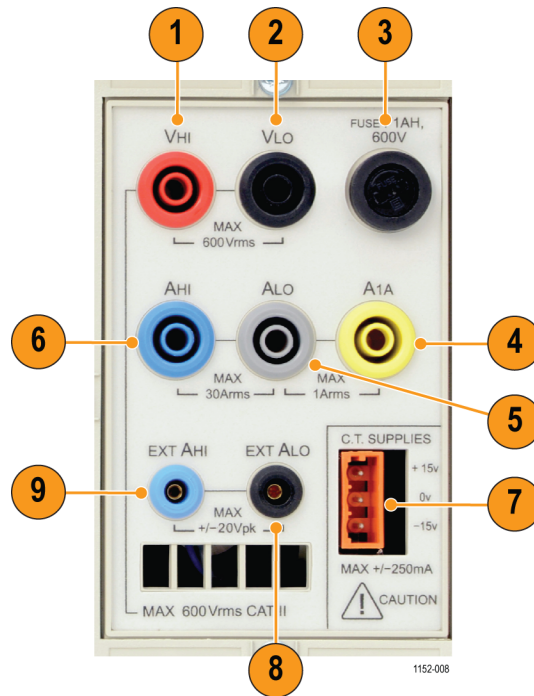

Figure 17: Signal inputs on rear panel (Channel 1 shown)

Table 2: Signal inputs on rear panel

Item	Description
1	Voltage high connection (VHI)
2	Voltage low connection (VLO)
3	T1AH, 250 V fuse to protect the 1 A shunt

Table 2: Signal inputs on rear panel (cont.)

Item	Description
4	1 A current high connection (A1A)
5	Current low connection (ALO, common to both the 30 A and 1 A shunt)
6	30 A current high connection (AHI)
7	± 15 V supply for powering external transducers
8	External shunt current input low (EXT ALO)
9	External shunt current input high (EXT AHI)

Voltage Voltages of up to $600 V_{\text{rms}}$ can be connected directly to the red and black 4 mm VHI and VLO safety sockets at the rear of each measurement channel of the PA3000.

Current The PA3000 has two built-in current shunts. The first shunt allows currents of up to $30 A_{\text{rms}}$, $200 A_{\text{pk}}$ to be connected directly to the blue and gray 4 mm AHI and ALO safety sockets at the rear of each measurement channel of the PA3000. The second shunt allows up to $1 A_{\text{rms}}$, $5 A_{\text{pk}}$ to be connected directly to the yellow and gray 4 mm A1A and ALO safety sockets also on the rear of each measurement channel.

External current inputs

The external current inputs accept a voltage of up to $\pm 20 V_{\text{pk}}$ that is proportional to the current being measured. This input allows a wide range of external current transducers to be connected, from low milliamp current shunts to high amplitude transducers. For each type of transducer, the PA3000 can be scaled to read the correct current. (See page 47, *Inputs*.)

The choice of current transducer will depend on:

- The current being measured, including peaks and transients.
- The accuracy required.
- The bandwidth required: Unless the waveforms are purely sinusoidal, a bandwidth in excess of the fundamental frequency will be required.
- Whether there is DC current present.
- Convenience of connection – that is, using a clamp-on current transformer, with jaws that open, for quick connection in a fixed wiring harness.
- The effect of the transducer on the circuit.

To connect a simple current transformer

To use a conventional current transformer (CT) like the Tektronix CL series (or any other transducer with a current output), connect the normal AHI and ALO inputs of the PA3000 to the outputs of the current transformer. Follow the manufacturer's instructions for the safe use and installation of the transducer. Depending on the output level of the current transformer, you will need to choose between the 30 A AHI input and the 1 A AHI input. The choice will be dependent on the dynamic range of the output of the current transformer that you are expecting.

Normally the positive or HI output of the transducer will be marked with the point of an arrow or a + symbol. Connect this terminal to the appropriate AHI input of the PA3000.

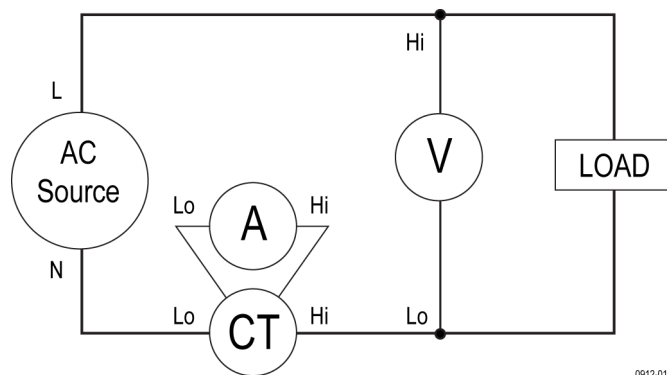













Figure 18: Current transformer connections

Current scaling

A current transformer produces an output current that is proportional to the load current being measured. For example, the Tektronix CL200 produces an output current that is 1/100 of the current being measured.

To measure the correct current on the PA3000, use the scaling function of the analyzer to scale, or multiply, the CT output current.

For example, the CL200 is a 100:1 CT. When measuring 100 A, its output is 1 A. To scale this on the PA3000, a scale factor of 100 must be entered:

- Press .
- Select   **Inputs** and press .
- Select   **Scaling** and press .
- Select   **Amps** and press .
- Use  to clear the entry.
- Enter the new scale factor (100).

Press 

Press  to return to the measurement display.

The PA3000 is now ready to make measurements using a CT.

To connect an external resistive shunt

Using a resistive shunt is a straightforward method of extending the current measuring range of the PA3000. The shunt resistor is connected in series with the load and the voltage across the shunt is directly proportional to current.

That voltage can be connected directly to the External Current Inputs of the PA3000.

For example, a 1 mΩ shunt is used to measure 200 A_{rms}.

1. Check that the voltage that will be generated is suitable for the PA3000

$$V = I \times R \text{ (Ohm's law)}$$

$$V_{\text{shunt}} = I \times R_{\text{shunt}}$$

$$V_{\text{shunt}} = 200 \text{ A} \times 0.001 \text{ } \Omega$$

$$V_{\text{shunt}} = 0.2 \text{ V}$$

This is well within the 20 V_{pk} rating of the PA3000's External Current Inputs

2. Connect the shunt in series with the load and to the EXT AHI and EXT ALO inputs as shown.

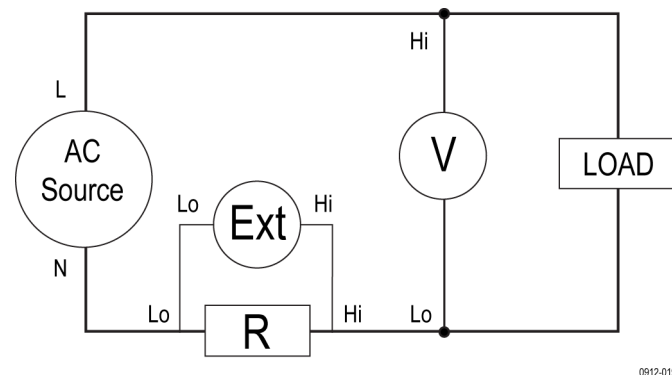

Figure 19: External resistive shunt connections

Remove any connections to the normal ALO terminal!



WARNING. *Connections to the normal AMPS terminals can have high voltage.*

To avoid errors and a risk of electric shock, remove all connections to ALO. EXT ALO and ALO are connected inside the PA3000 and so connections to AHI, ALO, and AIA can have the same potential as EXT ALO.

3. Set up the PA3000 to measure current from the EXT AHI and EXT ALO terminals.

Press

Select **Inputs** and press .

Select **Shunt** and press .

Select **External** and press .

Press to return to the measurement display.

4. Scale the measurement on the display.

The default scale is 1 V = 1 A.

In this example where $R = 0.001 \Omega$. The scaling factor is specified in amps-per-volt, so in this case, the scaling factor is 1000.

To enter a scale factor for current:

Press

Select **Inputs** and press .

Select **Scaling** and press .

Select **External Shunt** and press .

Use to clear the entry.

Enter the new scale factor (100).

Press

Press to return to the measurement display.

The PA3000 is now ready to make measurements using an external shunt.

To connect a transducer with a voltage output

These transducers contain active circuits that help to improve performance at high bandwidth. They can be of the Hall effect or Rogowski coil type.

The procedure is similar to that of installing an external shunt as described above.

1. Follow the manufacturer's instructions for the safe use and installation of the transducer.
2. Connect the voltage output to the EXT AHI and EXT ALO terminals of the PA3000 channel as above.
3. Set up the PA3000:

Press .

Select   **Inputs** and press .

Select   **Shunt** and press .

Select   **External** and press .

Press  to return to the measurement display.

4. Select and input a scale factor. These types of transducers are often rated in terms of mV / A. For example a transducer with an output of 100 mV / A is the equivalent of a 100 mΩ external shunt resistor. To convert the rated scaling from volts-per-amp to the desired amps-per-volt, invert the value. Using the above example, 100 mV / A is equivalent to 10 A / V.

Press .

Select   **Inputs** and press .

Select   **Scaling** and press .

Select   **External Shunt** and press .

Use  to clear the entry.

Enter the new scale factor (such as 0.1)

Press .

5. Press  to return to the measurement display.

The PA3000 is now ready to make measurements using a current transducer with a voltage output.

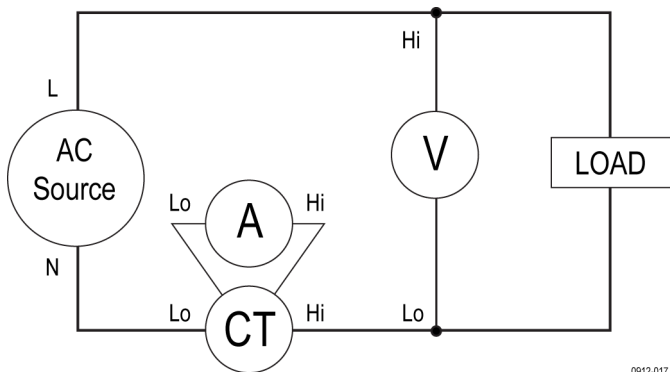

Figure 20: Current transformer connections

To connect a voltage transformer / transducer

The PA3000 can be used with a voltage transformer (VT) or other transducer to extend its measuring range. Follow the manufacturer’s instructions for the safe use and installation of the transducer.













The output of the transducer is connected to the normal VHI and VLO terminals. Normally the positive or HI output of the transducer will be marked with the point of an arrow or a + symbol. Connect this terminal to the VHI input of the PA3000.

Voltage scaling

A voltage transformer (VT) produces a voltage output, which is proportional to the voltage being measured.

To measure the correct voltage on the PA3000, use the scale function of the power analyzer to scale, or multiply, the VT output current.

For example, when measuring with a 1000:1 VT a scale factor of 1000 must be used.

- Press .
- Select   **Inputs** and press .
- Select   **Scaling** and press .
- Select   **Volts** and press .
- Use  to clear the entry.
- Enter the new scale factor (1000).
- Press .
- Press  to return to the measurement display.

The PA3000 is now ready to make measurements using a VT.

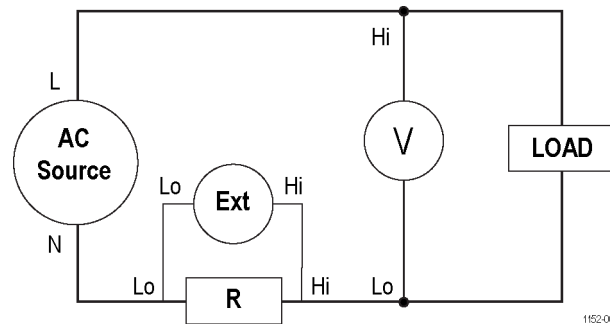

Figure 21: External resistive shunt connections

Power for external transducers

The PA3000 has a ± 15 V power supply for the purpose of providing power to external transducers. The supply is capable of supplying 250 mA per rail on each analog card (250 mA on +15 V and 250 mA on -15 V). The connector is conveniently placed next to the inputs on each analog card. Four mating connectors (Tektronix part number 56-598) are provided to aid in making a connection. These connectors are Wago 231-303/026-000.

The menu system

This section describes some of the key menus of the PA3000.

Measurements

Use the Measurements menu to set the order in which the measurements appear on the screen; default measurements are: V_{rms} , A_{rms} , Watt, VA, PF, and Freq. This is on a per-group basis. The measurements, on a group-by-group basis, can be displayed in any order, including harmonics. However, harmonic results will always be displayed as a block (all the voltage harmonics will be displayed as a continuous block based on the parameters set).

The following figure shows a normal Measurements screen.

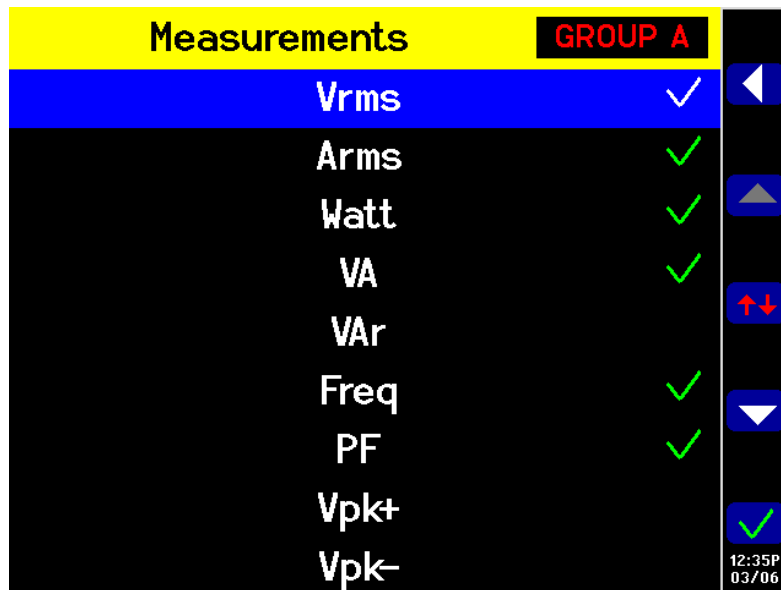







Figure 22: Measurements screen

On the measurements screen you can select a measurement to display as a result and change the order of the displayed results. The following soft keys available with the Measurements screen:

	Go to previous menu
	Selection Up or top of list
	Move Measurement

	Selection down or bottom of list
	Select measurement to be a result on the screen or de-select measurement

To navigate to a desired result, use the up and down arrow soft keys. The current selection will be highlighted in blue.

If a result is selected, it has a green check mark at the right edge of the list.





The results screen shows all the selected results, in the order in which they appear in the measurement list; the list only applies to the selected group.

NOTE. *Unless the group is in Integrator mode, integration measurements cannot be selected. These measurements are:*

- Hours*
- Watt-Hours*
- VA-Hours*
- VAr-Hours*
- Amp-Hours*
- Average Watts*
- Average PF*
- Correction VAr*
- Fundamental VA-Hours (VAHf)*
- Fundamental VAr-Hours (VArHf)*

To change the order of the results, navigate to the desired result and then press . When the key is pressed, the highlight bar changes from blue to red.

The soft keys will then change as shown below:

	Go back to the previous menu
	Move selected measurement up (gray if at the top of the list already).
	Cancel the move, and put the measurement back where it was before the move was started.
	Move selected measurement down (gray if at the bottom of the list already).
	Place the measurement in the selected position. The soft keys will change back to the standard measurement screen keys.

The following figure shows an example of a measurement being moved.

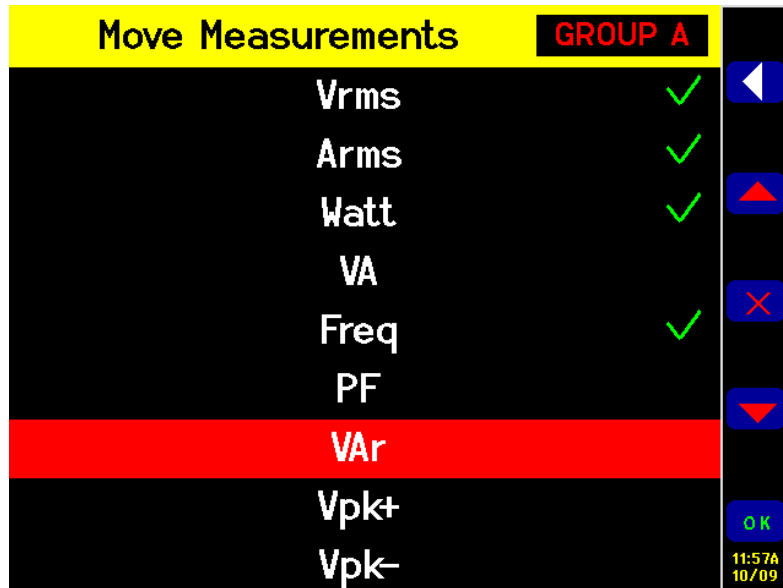

Figure 23: Example of a moved measurement

Measurement Configuration menu

Use the Measurement Configuration menu to change the way some results are computed and displayed.

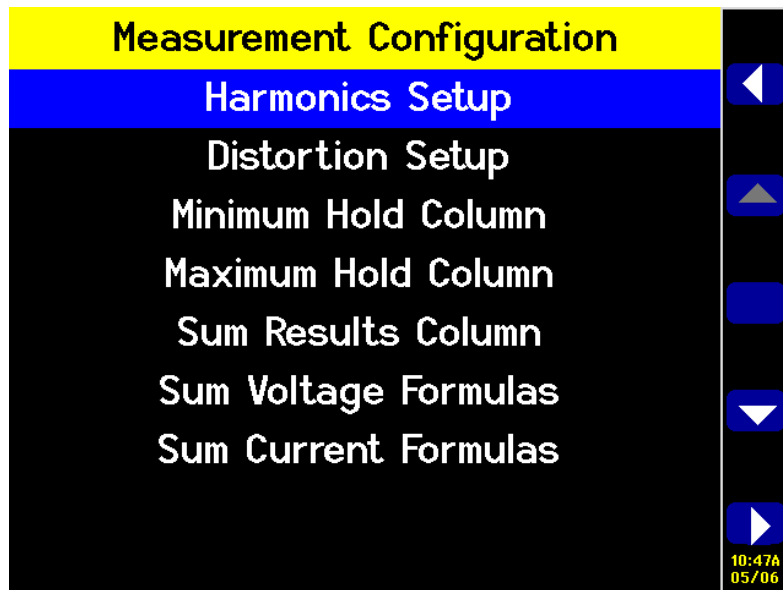

Figure 24: Measurement Configuration menu

The top-level menu consists of the following submenus:

- Harmonics Setup. Use these menus to configure V, A, and W harmonics.
- Distortion Setup
- Minimum Hold Column
- Maximum Hold Column
- Sum Results Column
- Sum Voltage Formulas
- Sum Current Formulas

Harmonics Setup

Use the Harmonics Setup to configure how quantities of harmonics are setup and viewed as measurement results. Individual voltage, current, and watts setups provide configurable options dependent on the application and how to view the results. There are separate voltage, current and watts menus that allow you to set the following items:

- **Sequence.** Odd and even or odd harmonic only (default Odd and even)
- **Range.** 1 to 100 (default 7)
- **Format.** Absolute or Percentage of the fundamental (default Absolute)
- **Display Phase Angle.** On or Off (default On) (volts and amps only)

Selecting the harmonics results to display has no impact on the harmonic data used in distortion calculations.

Please see the User Configuration section of this manual about update speed. (See page 61, *User Configuration*.) The instrument is not able to calculate and display 100 harmonics on V, A, and Watts every 100 ms.

Distortion setup

The Distortion Setup menu provides access to the voltage and current distortion factor (df), total harmonic distortion (THD), and telephone influence factor configurations.

Distortion factor. The distortion factor formula includes the effects of high frequency and noise. This equation only produces a valid number if the RMS is not less than the fundamental. If the fundamental is larger than the RMS the display shows - - - - -.

The equations are:

$$V_{df} = \frac{1}{V_{ref}} \sqrt{V_{rms}^2 - V_{h01}^2} \times 100\%$$

and

$$A_{df} = \frac{1}{A_{ref}} \sqrt{A_{rms}^2 - A_{h01}^2} \times 100\%$$

The reference value can be either the fundamental reading or the RMS reading. The default reference is the fundamental value.

Total Harmonic Distortion. THD is a measure of the distortion of a waveform.

Under the V and A measurement menus is the ability to set the following parameters:

- **Harmonic Reference.** Fundamental or RMS (default Fundamental).
- **Harmonic Sequence.** Odd and Even or Odd Only (default is Odd and Even).
- **Harmonic Range.** 2 to 100 (default 7). This is the last harmonic used in the calculation. If Odd Only harmonics are specified and the Range is set to an even number, the preceding harmonic will be the last one used.
- **Harmonic Zero.** Exclude or Include (default Exclude)

For the distortion settings and harmonics setting, the values will be remembered whether the actual displayed reading is turned on or off. For example, if the number of harmonics to be displayed is changed from 7 to 13, turning off and then on again the display of voltage harmonics will not affect this setting.

The formula for voltage and current THD are:

$$V_{thd} = \frac{1}{V_{ref}} \sqrt{\sum_{min\ harm}^{max\ harm} (V_{hn})^2} \times 100\%$$

and

$$A_{thd} = \frac{1}{A_{ref}} \sqrt{\sum_{min\ harm}^{max\ harm} (A_{hn})^2} \times 100\%$$

The Total Harmonic Distortion formula (previously called the series formula) will produce more accurate results for harmonic noise when the THD is less than 5%. When selecting the THD formula, it is important to set the maximum harmonics setting to an appropriately large number to get valid results. The higher the harmonic count the more accurate the calculation.

Telephone influence factor. The telephone influence factor (TIF) is a THD measurement weighted at frequencies within the bandwidth of a normal telephone circuit. It is a measure of how the voltage or current distortion in electrical power circuits might interfere with adjacent telephone circuits. TIF measurements are a requirement of standards such as ANSI C50.13 "Rotating Electrical Machinery - Cylindrical-Rotor Synchronous Generators" and are most often used on standby power generators and UPS. The harmonics included in a TIF measurement are from 1 to 73 odd and even.

The formula for voltage and current TIF are:

Default reference = Fundamental

$$V_{tif} = \frac{1}{V_{ref}} \sqrt{\sum_{min\ harm}^{max\ harm} (k_n \times V_{hn})^2}$$

and

$$A_{tif} = \frac{1}{A_{ref}} \sqrt{\sum_{min\ harm}^{max\ harm} (k_n \times A_{hn})^2}$$

The weighting factors (k_n) are:

Table 3: Weighing factors for TIF

Harm	k_n	Harm	k_n	Harm	k_n
1	0.5	21	6050	41	10340
3	30	23	6370	43	10600
5	225	24	6650	47	10210
6	400	25	6680	49	9820
7	650	27	6970	50	9670
9	1320	29	7320	53	8740
11	2260	30	7570	55	8090
12	2760	31	7820	59	6730
13	3360	33	8830	61	6130
15	4350	35	8830	65	4400
17	5100	36	9080	67	3700
18	5400	37	9330	71	2750
19	5630	39	9840	73	2190

Minimum and Maximum Hold Columns

The Minimum and Maximum Hold Columns provide a means for adding a new column along side the current selected results to display either the minimum or maximum values of the selected measurements. The columns can independently be enabled or disabled. To reset the values shown in the columns, press the RESET/CLEAR key. Each time either the minimum or maximum hold column is enabled, the values for both columns are reset.

Sum Results Column

The Sum Results Column provides a means to add a sum column along side the current group of measurements. The results are displayed for multi-channel groups. The column will appear after the last channel in the group. The maximum column will appear to the right of the sum results; the minimum column will appear to the left of the sum results as appropriate.

Sum results are available in all wiring configurations except 1 phase, 2 wire (1P2W). (See page 47, *Wiring*.)

Sum Voltage and Sum Current Formulas

The PA3000 provide a choice between two methods of summing voltage values and current values. The voltage methods are unrelated to the current methods. For a list of the sum voltage and current formulas, refer to sum equations later in this document. (See page 142, *Sum equations*.)

Modes

Modes are used to set up the instrument in specific way to allow certain types of measurements. These modes provide necessary filtering and unique configuration parameters to measure specific signals found in certain applications.

Modes are applied on a group basis. For example, in light ballast applications, group A could be in normal mode measuring the input power and group B could be in ballast mode measuring the output power.

The following modes are available:

- Normal
- Ballast
- Standby Power
- Integrator
- PWM Motor

It is often necessary to force the instrument in to a certain way of operating when a particular mode is selected. An example is forcing high bandwidth when Ballast mode is selected. In these cases two things will happen:

- Reverting back to Normal mode restores any changed settings.
- When a setting is forced, it cannot be changed by the operator while the power analyzer is in the non-normal mode

Normal mode Normal mode is used for most power measurements where signals are uniform and no special measurement methods are required. Normal mode is the default mode.

Ballast mode Ballast mode is designed to configure the group to make measurements on the complex ballast output modulated waveforms. In modern electronic lighting ballasts, it is often difficult to take accurate measurements because the output signals are high frequency waveforms that are heavily modulated by the power frequency. Ballast mode provides a way of locking the measurement period to the power frequency.

After selecting Ballast mode you need to set up the fundamental frequency at which power will be transmitted. This is typically 50, 60, or 400 Hz. The setup screen can be found under the **Modes** → **Setup Modes** → **Ballast Setup**. The power analyzer uses this to adjust the measurement window to fit the specified frequency.

The returned frequency is not the fundamental power frequency; but the ballast switching frequency. This is also the frequency used for harmonic analysis.

When Ballast mode is selected, the frequency range is set to “>10 Hz” and the bandwidth is set to “High” for the group. These settings are locked out in Ballast mode and, upon the return to normal mode, the settings are restored.

Standby Power mode

Standby Power mode integrates the watts, amps, VA and PF readings over a user-specified measurement period. This is a requirement of many standby power standards.

Driven by consumer demand and energy efficiency legislation, there is an ever-increasing need to measure power consumption of products while they are in standby mode.

One of the most widely used standards for measurement is IEC 62301. Part of this standard requires the measurement of power over a prolonged period of time without missing any short duration power events. The Standby Power mode provides continuous sampling of voltage and current to produce an accurate watts measurement over the user specified period.

In Standby Power mode, you must specify the integration window in seconds. Watts, amps, PF, and VA will then be integrated over the specified period. All other results will be updated at the normal user specified update rate.

The integration period depends on the combination of the specified window and the update rate of the instrument. (See page 60, *Update rate*.) This is because the results will be integrated over an exact multiple of the update rate. For example, if the update rate is 0.5 seconds (default), then the integration period will always be exactly as specified. However, if an update rate of 0.4 seconds is requested, then integration period will switch between 1.2 seconds and 0.8 seconds.

For the most accurate measurements it is recommended that the ranges are fixed during the measurement period. (See page 50, *Fixed/Auto ranging*.)

Integrator mode

Integrator mode provides measurements for determining energy consumption by integrating measurements over a specified period or by running continuously. Integration can be started manually, by a threshold trigger, or at a specific value. In addition, for certain parameters, average values are also available.

The required measurements are selected in the *Measurements* menu. (See page 36, *Measurements*.) The integrator measurements are:

- Hours
- Watt-Hours
- VA-Hours
- VAr-Hours
- Amp-Hours
- Average Watts
- Average PF
- Correction VAr
- Fundamental VA-Hours (VAHf)
- Fundamental VAr-Hours (VArHf)

These measurements are on a per-group basis. The measurements can only be selected and displayed when the group is in integrator mode. If an integrator measurement is selected and the mode is changed to a non-integrator mode, then the measurements will show as not being selected. Changing the group mode back to integrator mode restores the selection previously used.

Configuring Integrator mode

After selecting integrator mode, and the measurements to display, there are a number of options provided for starting and stopping the integrator under **Modes** → **Setup Mode** → **Integrator Setup**. The following options are available:

- **Start Method.** Select from Manual, Clock, or Level.
- **Configure Clock Start.** Specify a Start Time and Start Date.
- **Duration.** Specify the integrator run duration, measured in minutes. A duration of 0.0 will run indefinitely.
- **Configure Level.** Select a channel, signal, threshold, or direction.
- **CVars Power Factor.** Specify the desired power factor to be used for the correction VARs in the range of ± 1.0 V.

Start method. The Start methods are described below.

- **Manual start.** This is the default method. Manual starting of integration is triggered with the **INTEG RUN** key on the front panel. Press this key to start the integrator running on all groups configured as integrator mode with a manual start and are currently not running. The LED under the key turns on.
- **Clock start.** Use this mode to set the time and date of when you want the integration to start for the group. The time and date are entered in the specified format under the Clock menu under *System Configuration* (See page 60.). Once the desired time has been reached, integration will start.

If you set a time / date combination before the current time and date, then integration will not start. Integration will only start after at least one screen update has occurred before the start time.

- **Level start.** In this start method, you have the ability to start integrating when a certain parameter either goes above or below a user entered level. Once the conditions have been met, integration will start.

You can configure the following:

- Select the channel, 1 through 4.
- Select a signal parameter from that channel. This can be any parameter with the exception of integrated values and harmonic values (including fundamentals).
- Select the threshold level to be monitored. This is the actual parameter value in decimal. For example, for 80 mA enter 0.08; for 80 V enter 80.
- Select whether the signal level should be greater than or equal to the level or less than or equal to the level.
- A trigger Channel 1-4 can be selected from any group and used as a trigger for integration. The trigger measurement does not have to be in the channel or group that you are integrating.

Stopping integration. The integration of a group can be stopped manually or after a certain period of time. If the duration for the group is set to zero, then the integration will only stop if the **INTEG RUN** key is pressed. The duration is entered in minutes as a floating point number from 0.0 to 10,000.

When you press the **INTEG RUN** key to manually stop the integration, integration stops on all groups that are in integrator mode with the integrator running where the duration is set to zero. The LED under the key turns off if there is no more integration going on within any group.

Resetting integration values. The **RESET/CLEAR** key will reset the integration values to zero for all stopped groups. It has no effect on groups that are running integration.

Correction VAR (CVAr). This parameter displays the values of VARs required to correct the average power factor to a target power factor. The target power factor is entered under the integrator setup screen under CVAr Power Factor.

The correction will calculate the necessary VARs to provide a phase shift to reach a target power factor. It does not compute the total VARs. If a poor power factor is completely due to distortion, no amount of phase lead or lag will improve it.

PWM Motor mode

PWM Motor mode allows accurate measurements of PWM motors. It is designed to overcome the difficulties associated with making measurements on the complex waveforms found on the motor drive. High frequency sampling is combined with digital filtering to reject the carrier frequency and extract the motor frequency while still using pre-filtered data for power parameters.

After selecting PWM mode, select the frequency range of the motor frequency (not the carrier frequency) under the **Inputs** → **Frequency Source** → **Frequency Range** menu.

When in PWM mode, the maximum motor frequency is limited to 900 Hz, even if a higher frequency range is selected.

The selection of the frequency range will impact the rate at which results are returned. The update rate for all the channels is set in the System Configuration menu. (See page 60, *Update rate*.) However, if the frequency range in PWM mode is set to either 1 – 100 Hz or 0.1 – 10 Hz, then the rate at which results are returned for that group is altered per the table below:

Table 4: Effects of frequency range settings in PWM mode

Update rate (seconds)	>10 Hz <900 Hz	1 – 100 Hz	0.1 Hz – 10 Hz
0.2	0.4	2.4	20.2
0.3	0.3	2.4	20.4
0.4	0.4	2.4	20.4
0.5	0.5	2.5	20.5
0.6	0.6	2.4	20.4
0.7	0.7	2.1	20.3
0.8	0.8	2.4	20.8
0.9	0.9	2.7	20.7
1.0	1.0	3.0	21.0
1.1	1.1	2.2	20.9
1.2	1.2	2.4	20.4
1.3	1.3	2.6	20.8
1.4	1.4	2.8	21.0
1.5	1.5	3.0	21.0
1.6	1.6	3.2	20.8

Table 4: Effects of frequency range settings in PWM mode (cont.)

Update rate (seconds)	>10 Hz <900 Hz	1 – 100 Hz	0.1 Hz – 10 Hz
1.7	1.7	3.4	20.4
1.8	1.8	3.6	21.6
1.9	1.9	3.8	20.9
2.0	2.0	4.0	22.0

Results from channels not in PWM Motor mode will be returned at the specified rate.

Inputs

The Inputs menu provides configuration options for all physical signal inputs of the power analyzer. Use this menu and the submenus to configure all wiring and group settings. For normal operation, with the exception of the shunt selection, it is not necessary to change these settings from the default values.

Wiring

For multiphase measurements, a number of channels can be assigned to a group allowing precise frequency and phase analysis of the multiphase signals. The frequency of the first channel in the group is used as the fundamental frequency for all channels in the group, and all phase measurements are relative to the phase reference (voltage by default) of the first channel in the group.

Below are figures showing how each channel would be connected for each different wiring mode.

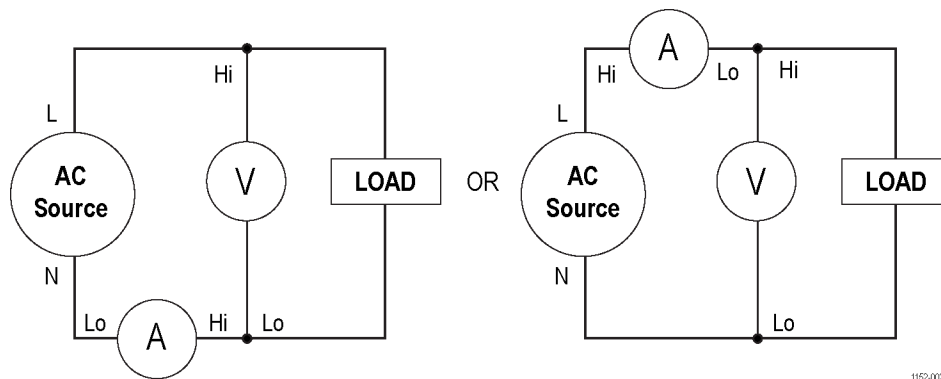

Figure 25: Single-phase, two-wire and DC measurements. Select 1 phase, 2 wire mode

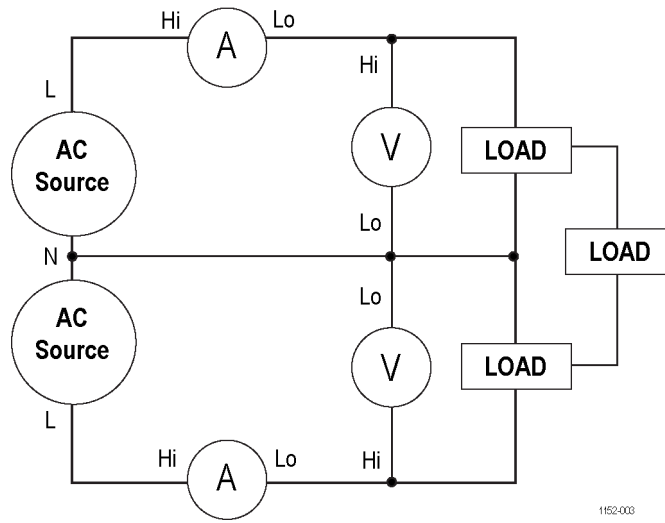

Figure 26: Single-phase, three-wire. Select 1 phase, 3 wire

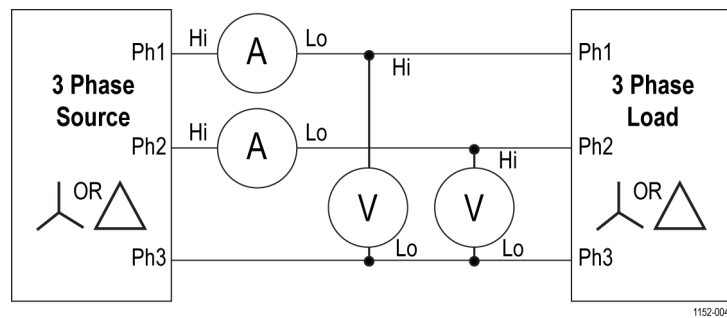

Figure 27: Three-phase, three-wire (2 Wattmeter method). Select 3 phase, 3 wire

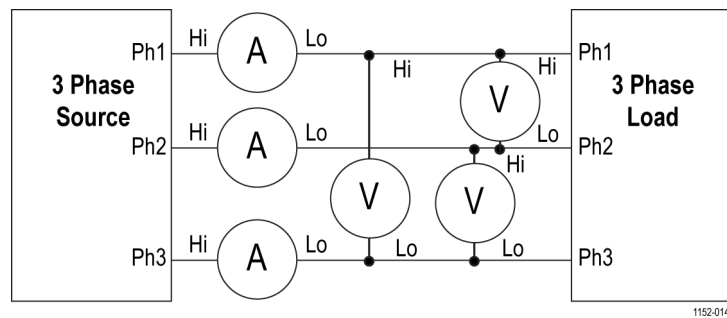

Figure 28: Three phase, three wire (3 Wattmeter method). Select 3 phase, 3 wire (3V3A).

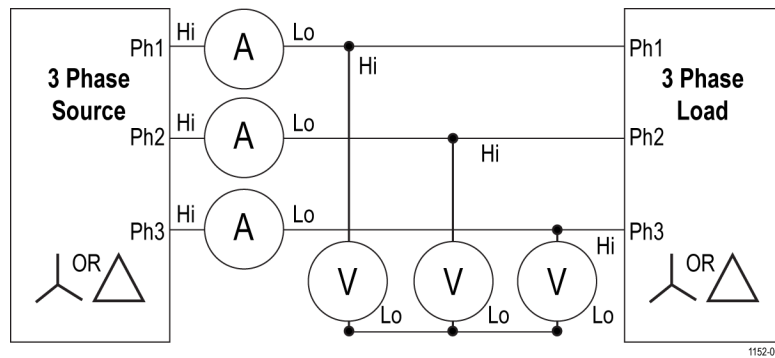

Figure 29: Three-phase, three-wire (3 Wattmeter method). Select 3 phase, 4 wire

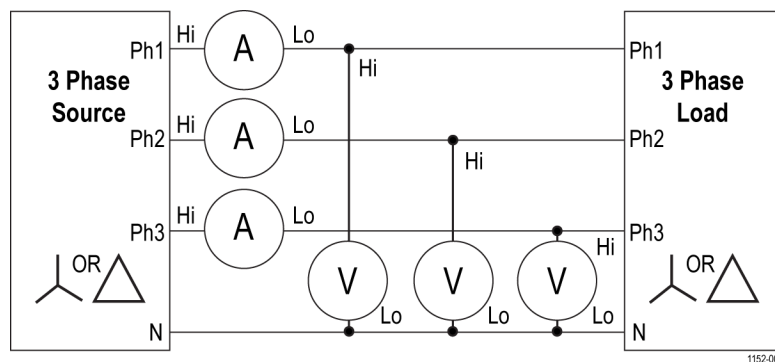

Figure 30: Three-phase, four-wire (3 Wattmeter method). Select 3 phase, 4 wire

Depending on the wiring configuration, not all groups will be available. For example, if wiring is 1p2w for each channel, then the four channels will correspond to the four groups. If the wiring is 1p3w for group A, then Channels 1 and 2 will be in-group A. This leaves Channels 2 and 3 for a maximum of groups B and C. Group D cannot exist in this condition.

Group A wiring takes priority, followed by groups B, C, and then D. For example, starting from a 1p2w configuration for all groups, if group A is set to 1p3w, then group D cannot be set to anything and therefore group C will be 1p2w only. Group B will have the choice of 1p2w, 1p3w and 3p3w.

Line-to-Line measurements are only valid when the signal frequency is less than 1 kHz. They are only valid in the 1p3w, 3p3w, and 3p4w wiring configurations.

Line-to-neutral measurements are only valid in the 3p3w and the 3p3w (3V3A) wiring configurations. The neutral current (AN) values in the math formulas is the phase 3 line current when in the 3p3w wiring configuration.

Ranging Ranging sets the voltage or current range to a particular fixed range or to allow ranging to automatically occur, depending on the application. For example, current inrush testing requires the current range to be fixed; auto-ranging would not be fast enough to capture the highest current inrush. The list of available current ranges depends on the selected shunt.

The ranges are set on a group basis. The ranges will be as follows:

Table 5: Input ranges

Range #	Volts	30 A shunt	1 A shunt	Ext. shunt
Auto				
4	5 V	0.5 A	0.0125 A	0.05 V
5	10 V	1 A	0.025 A	0.1 V
6	20 V	2 A	0.05 A	0.2 V
7	50 V	5 A	0.125 A	0.5 V
8	100 V	10 A	0.25 A	1 V
9	200 V	20 A	0.5 A	2 V
10	500 V	50 A	1.25 A	5 V
11	1000 V	100 A	2.5 A	10 V
12	2000 V	200 A	5 A	20 V

Fixed/Auto ranging. Auto ranging is the default selection; this is the best choice for most measurements. Choosing a fixed range can be useful if the voltage or current is changing continuously or has large peaks that make the power analyzer spend excessive time changing ranges.

If you choose a fixed range, or the peak of the input signal is larger than the range, then an over range condition will occur. This will be indicated on the screen by all the results in the over ranged channel flashing on and off. In addition, the “Vrms” and/or “Arms” will flash to indicate whether the over-range is on either the voltage channel, the current channel, or both.

Shunts. The power analyzer has three different current inputs, or shunts. They are:

- **Internal 30 A.** This is the default value and is used for normal current measurement up to 30 A_{rms} (200 A_{pk}). This selection uses the blue AHI and the gray ALO 4 mm sockets on the rear panel.
- **Internal 1 A.** This is used for small current measurements such as those found in standby power applications where current is less than 1 A. This selection uses the yellow A1A and the gray ALO 4 mm sockets on the rear panel.
- **External.** This is used for the measurement of current where an external transducer is used and the transducer has a voltage output. The blue and black 2 mm sockets on each analog card are used for the external shunt inputs.



CAUTION. *Passing an rms current of greater than 15 A when the instrument power is off can damage the instrument. To avoid damaging the instrument, do not apply rms currents of greater than 15 A when the instrument is off.*

Frequency Source The Frequency Source menu provides the following selections:

- Source
- Phase Reference
- Frequency Range

Source. Many measurements (including rms volts, amps and watts) are based on calculations are dependent on the correct fundamental frequency being determined by the power analyzer. The PA3000 uses proprietary techniques to determine frequencies that eliminate problems created by noise when simple zero-crossing techniques are used. It is therefore not normally necessary to adjust the settings from the default of voltage.

The following source selections are available:

- **Volts.** This is the default frequency source and is suitable for most applications.
- **Amps.** Amps can be selected if the voltage waveform is heavily distorted, but the current is not. The waveforms at the output of a PWM motor drive are an example of this.
- **External Frequency 1 / 2.** On the rear of the power analyzer there are two counter inputs on the Auxiliary Inputs / Outputs connector. Either of these can be used as an external frequency source for signals where there is too much noise on the voltage and current waveforms. Apply a TTL compatible square wave to the external input at the required frequency.

Phase Reference. The Phase Reference is used for harmonic analysis to create a zero-degree reference point.

The following selections are available:

- Volts. This is the default selection; the phase is calculated with respect to the voltage signal on the first channel in the group.
- Amps. Phase is calculated with respect to the current signal on the first channel in the group.
- External Frequency 1 / 2. Phase is calculated with respect to the external input signal.

Frequency Range.

There are three frequency ranges:

- **>10 Hz.** This is the default selection.
- **1 – 100 Hz**
- **0.1 – 10 Hz**

If the fundamental frequency is greater than 50 kHz, then the range should be set to >10 Hz. For measurements where the fundamental is below 50 kHz, the range of >10 Hz is recommended, especially at low signal levels. The 1 – 100 Hz and 0.01 – 10 Hz ranges should only be used with slow signals; using these ranges slows the update rates.

Bandwidth The bandwidth is set on a per-group basis. Setting the bandwidth to low applies a 10 kHz, two-pole filter to the voltage and current channel inputs. High is the default selection.

Scaling Scaling adjusts the scaled output of transducers, such as current transformers, so that the true measured current is displayed on the power analyzer. The scaling factor affects every measured value related to the input to which it is applied. The maximum scale factor is 100000; the minimum is 0.00001. The default selection is 1.0000 for all scale factors.

Volts scaling. Enter the scale factor of the transducer. For example, a 100:1 voltage transformer is used to measure 15 kV. The output of the transformer is $15000 / 100 = 150$ V. Enter the scale factor 100, and the power analyzer will display 15,000 V.

Amps scaling. Enter the scale factor of the transducer being used. For example, the Tektronix CL1200 produces 1 A for every 1000 A flowing in the opening of the CL. It is a 1000:1 current transformer. Enter the scale factor 1000 and the power analyzer will display the correct current.

Scale factor = Transducer Input Current ÷ Transducer Output Current.

External shunt scaling. This scaling is applied to the current measurement channel voltage inputs. This is used for current transducers that have a voltage output. These include Hall effect transducers as well as simple resistive shunts.

The scaling factor is expressed in Amps (read) per Volt (applied). The default value is 1. This means that with 1 V_{rms} applied, the current channel will read 1 A_{rms} .

An example would be a clamp-on Hall effect current transducer measures up to 100 A. It has a voltage output of 10 mV per Amp, which is equivalent to 100 A / V. Enter “100.00” and the power analyzer will display the correct system current.

Analog inputs The power analyzer has four analog inputs on the rear of the instrument. Each of the four inputs can be used to measure signals from a device such as a torque or speed sensor. Each of the four inputs has two different ranges. The ranges are ± 10 V (default range) and ± 1 V. Each input is sampled every millisecond and the reported measurement is the average of the samples over the time period controlled by the update rate.

Analog inputs are made available to the MATH setup. They can be incorporated into the MATH formula and displayed on the MATH screen. (See page 56, *Math results*.)

Graphs and waveforms

The PA3000 provides different ways to display data:

- Waveforms
- Harmonic bar charts
- Vector diagrams
- Integrator graphs

There are menu options for waveforms and integrator graphing, bar charts, and vector diagrams. (See page 12, *Quick view keys*.)

Waveforms Use the waveform menu to select waveforms to display. For each group, you can select any voltage, current, or watts waveform for each channel in the group to display on the waveform graph. (See page 12, *Quick view keys*.)

To change groups use the left and right arrow keys at the bottom left of the display.

Integrator parameters Use the Integrator Graph menu to select one parameter to display on the integrator graphing screen. The following integrator parameters are available:

- Watt Hours
- VA Hours

- VAr Hours
- Amp Hours
- Watts Average
- PF Average
- Volts
- Amps
- Watts
- Fundamental VA-Hours (VAHf)
- Fundamental VAr-Hours (VArHf)
- Correction VArS

For each waveform selected, there is a choice on the graph menu to turn on or off the selected parameter for each channel in the group.

Integrator graphing parameters are set on a per-group basis. To change groups use the left and right arrow keys at the bottom left of the display.

Additional information is available for setting up the integrator. (See page 43, *Integrator mode*.) Additional information is available for displaying the integrator waveforms. (See page 17, *Integrator screen*.)

Interfaces

This menu can be used to set up the remote control interfaces of the PA3000.

RS-232 baud rate 9600, 19200, and 38400 (default) are available.

The PA3000 uses hardware handshaking (RTS / CTS) with no parity, eight data bits and one stop bit (N,8,1).

The RS-232 baud rate is unchanged after a “*RST” or “:DVC” command.

GPIB address Enter the GPIB address.

Default address is 6. The address is unchanged after a “*RST” or “:DVC” command.

Ethernet The PA3000 offers Ethernet communications through an Ethernet port using TCP/IP.

The Ethernet port will make a TCP/IP connection on port 5025. Port 5025 is designated by the Internet Assigned Numbers Authority (IANA) to be a SCPI port.

Use the IP Selection Method menu, to opt for a dynamically assigned IP address, by selecting **Set IP using DHCP**, or a fixed/static IP address by selecting **Fix IP Address**. To view the current IP settings, press  and scroll to the bottom of the menu.

To configure the static IP address, choose **Static IP Settings** in the Ethernet Setup menu. This allows entry of the IP address, the subnet mask and the default gateway. After entering the relevant data press , in each menu, to apply.

For basic communication needs via TCP/IP, refer the information available from National Instruments at (<https://www.ni.com/visa>).

The Ethernet mode (Static/DHCP), IP address, default gateway and subnet mask are unchanged after a “*RST” or “:DVC” command.

Dead socket connection. The dead socket termination (DST) port 5030 is used to terminate an existing Ethernet connection. A dead socket is a socket that is held open by the instrument because it has not been properly closed. This most often happens when the host computer is turned off or restarted without first closing the socket. This port cannot be used for command and control functions.

Use the dead socket termination port to manually disconnect a dead session on an open port. An existing Ethernet connection will be terminated and closed when the connection to the dead socket termination port is made.

Datalog

You can configure the USB data logging interval. To configure the data logging interval, press , go to Interfaces and select USB Host Data Out.

Math results

The math results are displayed on a different results screen from the other results. This improves the ability to view math results. Normal measurement parameters can be displayed on the math results screen. They just have to be specified in a formula. (See page 20, *Math screen*.)

You can set the values of up to 30 math functions, labelled FN1 through FN30. For each function you can specify the following:



- **Name.** User-friendly name up to 10 characters. (Default is the same as the label, for example, FN1.) In the menus, the function label is always displayed alongside the user's name for the function.
- **Units.** User friendly units such as W for watts. (Default is blank). Scaling such as u, m, k, M will be added to the unit as appropriate. Units are up to four characters.
- **Function.** The actual math formula, up to 100 characters.

Example: $W = 21.49$, $VA = 46.45$

Name = "PF"

Units = "PF"

Function = "CH1:W / CH1:VA"



To select this function for viewing, go to the MATH menu list showing FN1 – FN30 and press  to select the function. Next press  to display the result value of the function; the math results display shows "PF 463.27 mPF".

Example: $CH1:W = 21.49$, $CH2:W = 53.79$

Name = "EFFICIENCY"

Units = "%"

Function = "(CH1:W/CH2:W)*100"

To select this function for viewing, go to the MATH menu list showing FN1 – FN30 and press  to select the function. Next press  to display the result value of the function; the math results display shows "EFFICIENCY 39.95 mw".

You can specify any channel or group parameter listed below in addition to the voltage input on each of the four analog inputs.

- Valid characters are A-Z, 0-9, ., x, -, +, /, (,), :, space, and ^
- No more than 100 characters can be used
- The number format is [+/-]<decimal digits>[E[+/-]exponent]

When entering a formula you can use the left and right arrow keys to move the cursor. This allows for easy correction and changing of complex formulas.

Each math function can be either enabled or disabled. Only enabled results are available for display.

The valid channel parameters are CH<1 – 4> followed by ":" and then one of the following parameters:

Table 6: Valid channel parameters

VRMS – Volts RMS	ACF – Amps Crest Factor	VAHF – Fundamental VA Hours
ARMS – Amps RMS	VTHD – Voltage Total Harmonic Distortion	VARHF – Fundamental VAR Hours
W – Watts	VDF – Voltage Distortion Factor	VF – Fundamental Volts
VA – Volt-Amps	VTIF – Voltage Telephone Influence Factor	AF – Fundamental Amps
VAR – Volt-Amps Reactive	ATHD – Amps Total Harmonic Distortion	WF – Fundamental Watts
FREQ – Frequency	ADF – Amps Distortion Factor	VAF – Fundamental Apparent Power
PF – Power Factor	ATIF – Amps Telephone Influence Factor	VARF – Fundamental Volt-Amps Reactive
VPKP – Volts Peak (positive)	Z – Impedance	PFF – Fundamental Power Factor
VPKN – Volts Peak (negative)	R – Resistance	VRNG – Voltage Range
APKP – Amps Peak (positive)	X – Reactance	ARNG – Amps Range
APKN – Amps Peak (negative)	TINT – Integration Time (Hours)	VLL – Line-to-Line Voltage
VDC – Volts DC	WHR – Watt Hours	VLN – Line-to-Neutral Voltage
ADC – Amps DC	VAHR – VA Hours	VHA<1-99> – Voltage Harmonic Angle (1-99)
VRMN – Rectified Mean Volts	VARH	VHM<1-99> – Voltage Harmonic Magnitude (1-99)
ARMN – Rectified Mean Amps	AHR – Amp Hours	AHA<1-99> – Current Harmonic Angle (1-99)
VCMN – Volts Corrected Rectified Mean	WAV – Average Watts	AHM<1-99> – Current Harmonic Magnitude (1-99)
ACMN – Amps Corrected Rectified Mean	PFAV – PF Average	WHM<1-99> – Watts Harmonic Magnitude (1-99)
VCF – Volts Crest Factor	CORRVARS – Correction VARs	

The valid group parameters are GRP<A-D>: followed by one of the following parameters:

Table 7: Valid group parameters

AN	Neutral current (or phase 3 current for 3p3w)
----	---

The valid group sum parameters are GRP<A-D> followed by ":SUM:" and then one of the following parameters:

Table 8: Valid group sum parameters

VRMS	Volts RMS	ARMS	Amps RMS
W	Watts	VA	Volt-Amps
VAR	Volt-Amps Reactive	PF	Power Factor
AHR	Ampere Hours	WHR	Watt Hours
VAHR	VA Hours	VARH	VAr Hours
WAV	Watts Average	PFAV	PF average
TINT	Integration Time	CORRVARs	Correction VARs
WF	Fundamental Watts	VF	Fundamental Volts
AF	Fundamental Amps	VARF	Fundamental Volt-Amps Reactive
PFF	Fundamental Power Factor		

The follow parameters are used to return the values from the analog and counter inputs:

Table 9: Parameters for returning values from the analog and counter inputs

ANA1	Analog Input 1	ANA2	Analog Input 2
ANA3	Analog Input 3	ANA4	Analog Input 4
COUNT1	Counter 1 frequency	COUNT2	Counter 2 frequency

In addition, a function can refer to another function by using “FNx” where x is the function number. Functions will be calculated in the order of 1 through 30, so this will have to be factored in when writing functions.

Operators available from the front panel keypad are:

- + - x / ()
- X^2 . Shown as ^2 and will square the preceding number
- X^y . Shown as ^ and will take the preceding number to the power of the following number
- $\sqrt{\quad}$. Shown as SQRT() and will take the square root of the number between the brackets

Operators that can be typed:

- SIN(), COS(), TAN(). These operators take an angle in degrees which is between the brackets and return its sine, cosine or tangent.
- ASIN(), ACOS(). These operators take a number between -1 and 1 which is between the brackets and return an angle in degrees.
- ATAN(). This operator takes a number that is between the brackets and returns an angle in degrees.
- LN(), LOG(). This operator returns the logarithm of the number between the brackets. LN is log to the base e, LOG is log to the base 10.

Constants that can be typed:

- PI. Where $\pi \approx 3.14159$

NOTE. When the shift key turns on, operators such as COS(), SIN(), and TAN() will be entered as whole words. Operators such as ACOS(), ASIN(), ATAN(), LN(), and LOG() must be typed as individual letters when the shift key is turned on.

The formula is checked for validity when OK is selected. If there is an error, then an error message is displayed. If there are no errors the calculated value will be shown at the bottom of the screen.

If the math result is invalid (for example, infinity because of a divide by zero) the display will show four dashes.

System Configuration

Blanking Use Blanking to zero the results below a given value. The Blanking levels are set to 5% of the currently selected range.

When Blanking is enabled (default), all values below the threshold will show a zero value. Disable Blanking to measure small voltages or currents.

If blanking operates on either voltage or current then all related measurements would be blanked including W, VA and PF.

Averaging An averaging depth of between 1 and 10 can be specified. The default value is 10. With the update rate set to 0.5 seconds, this corresponds to values being averaged over five seconds.

If the range is changed, the averaging is reset.





Update rate The update rate determines how often new results are available in the instrument. The values in the Update Rate menu list indicate the time interval (in seconds) between every update of the results. Restrictions are placed on the number and type of results permitted at faster update rates.

The range is 0.2 s to 2 s in 0.1 s increments, where 0.5 is the default value. With update rates below 0.5 seconds, the number of results that can be updated at that rate is limited.

Autozero Autozero is a method of automatically canceling any small parasitic signals, such as DC offsets, in the measurement. Three options are available:

- **On.** (default) The instrument runs autozero every minute.
- **Off.** When autozero is disabled the instrument uses the last autozero values.
- **Run Now.** The instrument runs an immediate autozero on the currently selected ranges. This takes approximately 100 ms. The state of whether autozero is either enabled or disabled will not be changed, and there is no feedback to indicate it has run.

Clock Use the following options to check or set the internal clock:

- **Set Time.** Enter the time using the format shown and press  to confirm.
- **Set Date.** Enter the date using the format shown and press  to confirm.
- **Time Format.** Select 12 Hour or 24 Hour and press  to confirm.
- **Date Format.** Select the required date format and press  to confirm.

Power saving The instrument has the ability to reduce its own power consumption by switching off the display.

In the Display menu you have the following options:

- **Always On.** This is the default mode and the display will always be on.
- **Switch off after 10 minutes.** The display turns off after 10 minutes if no key is pressed. Pressing any key turns the display on again.
- **Switch off in remote mode.** If the instrument receives a command through any of the communication interfaces, the display turns off. Pressing any key turns the display on again, but the instrument will remain in the remote mode until the LOCAL key is pressed. Pressing the LOCAL key to switch the display on will not return the instrument to local mode.

Analyzer Configuration

The Analyzer Configuration menu has the same function as the  (SETUP) key. Selecting this menu displays the complete instrument setup. Use the up and down soft keys to scroll through the configuration.

Pressing the right arrow key changes the configuration screen to display information on the physical unit. This includes the serial number of the unit, the firmware version, and information on the main card and analog cards, including calibration date.

User Configuration

The User Configuration menu provides the means for loading changing the current configuration.

Load Default Configuration

Choosing this option by pressing  sets every menu option of the PA3000 to its factory default. The defaults are listed in previous sections of this chapter.

Load from USB

Load a configuration from a file on an attached USB flash drive.

Save to USB

Save the current configuration to a file on an attached USB flash drive in the \PA3000 folder.

The file name is of the format CONFIGXY.CFG, where XY is the first available number in the sequence of 01 to 99. For example, if a file named CONFIG01.CFG already exists on the flash drive, then the new configuration will be named CONFIG02.CFG.

Configuration

Save or load preset user configurations using one of eight selectable internal storage locations.

For each user configuration you can do the following:

- Apply the saved configuration.
- Rename the configuration. A name can have up to 16 characters.
- Save a configuration. This is the complete setting of the instrument at the time you choose this option.

NOTE. Loading a configuration that has never been saved results in an error message. The current configuration of the unit will not be changed.

Remote operation

Overview

Using the remote commands the instrument can be used to perform high speed, complex, or repetitive measurements. All PA3000 instrument communicate by RS-232, Ethernet, or USB as standard. Optionally, a GPIB port can be added.

Interfacing with RS-232 systems

The RS-232 port is a standard PC type 9-way male D-type located on the rear of the instrument and can be used for remote control of the PA3000. A modem cable should be used.

The RS-232 port uses 8 bits, no parity, one stop bit and hardware flow control.

See *Serial Port* for a detailed pin description of the RS-232 connector. (See page 149, *Serial port*.)

See *RS-232 Baud Rate* for details on the interface menus. (See page 54, *RS-232 baud rate*.)

Interfacing with USB systems

The PA3000 supports USB control using the Test and Measurement class.

A detailed pin description of the port, along with speed and connection information is given in the *Reference* section of this document. (See page 146, *Communication ports*.)

Interfacing with Ethernet systems

The PA3000 supports Ethernet control using a 10Base-T network.

See *Ethernet Port* for more information on the Ethernet connection. (See page 147, *Ethernet port*.)

See *Ethernet Configure* for information on how to set up the Ethernet addressing information. (See page 54, *Ethernet*.)

Interfacing with GPIB systems (optional)

The PA3000 optionally supports control via a GPIB port. This option must be installed by an authorized Tektronix representative.

See *IEEE 488/GPIB* for a detailed pin description of the GPIB connector. (See page 148, *IEEE 488 / GPIB (Optional)*.)

Status reporting

Status byte

The PA3000 uses a similar status byte to IEEE 488.2. The PA3000 Status Byte Register (STB) contains the ESB and DAS bits. These two bits indicate a non-zero state in the Standard Event Status Register (ESR) or the Display Data Status Register (DSR) respectively.

The ESR and DSR each have enable registers, ESE and DSE respectively, set by the user. These enable registers act as a mask to reflect chosen elements of the appropriate status registers to the Status Byte Register. Setting the appropriate bit of the enable register to 1 configures the bits to be summarized in the STB.

If a status byte is read, the DSR and ESR registers are cleared.

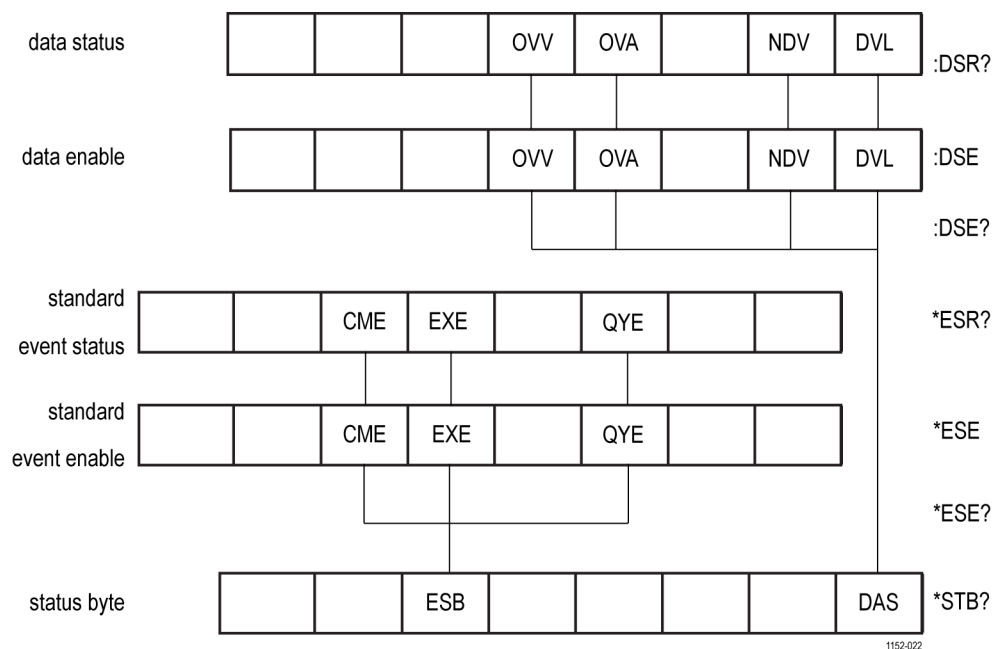

Figure 31: Status byte

Status Byte Register (STB)

Read by “*STB?”.

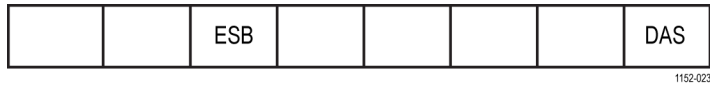

Figure 32: Status byte register

Table 10: Status byte register bit definitions

Bit	Name	Description
5	ESB	Event status summary bit to show standard event status
0	DAS	Display status summary bit to show display data

Display Data Status Register (DSR)

Read by “:DSR?” or in summary by *STB? DAS bit. On power-up DSR is initialized to zero. When read using the “:DSR?” command the register bits are cleared.

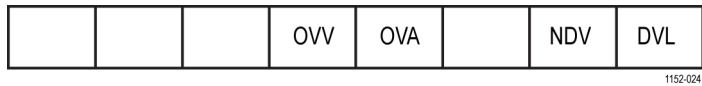

Figure 33: Display Data Status Register

Table 11: Display data status register bit definitions

Bit	Name	Description
4	OVV	Set to indicate there is a voltage range overload
3	OVA	Set to indicate there is a current range overload
1	NDV	Set to indicate that new data has become available since the last :DSR? command
0	DVL	Set to indicate the availability of data

Display Data Status Enable Register (DSE)

Read by “:DSE?” and set by “:DSE <value>”.

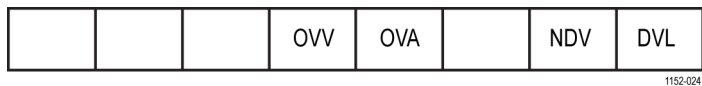

Figure 34: Display Data Status Enable Register

Table 12: Display data status enable register bit definitions

Bit	Name	Description
4	OVV	Enable OVV bit
3	OVA	Enable OVA bit
1	NDV	Enable NDV bit
0	DVL	Enable DVL bit

Standard Event Status Register (ESR)

Read by “*ESR?” or in summary by the ESB bit in STB.

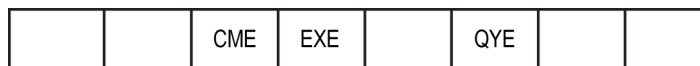

1152-021

Figure 35: Standard Event Status Register**Table 13: Standard event status register bit definitions**

Bit	Name	Description
5	CME	Command error; command not recognized
4	EXE	Command execution error
2	QYE	Query error

Standard Event Status Enable Register (ESE)

Read by “*ESE?” and set by “*ESE <value>”.

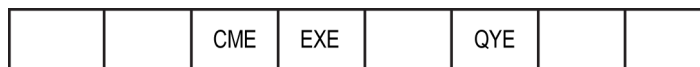

1152-021

Figure 36: Standard Event Status Enable Register**Table 14: Standard event status enable register bit definitions**

Bit	Name	Description
5	CME	Enable CME bit
4	EXE	Enable EXE bit
2	QYE	Enable QYE bit

Command listing

The following conventions are used for command syntax:

- Square brackets indicate optional parameters or keywords [].
- Angle brackets indicate values to be specified < >.

Commands and responses are sent as ASCII strings terminated with a line feed. The PA3000 is not case sensitive and white space characters are ignored except where required between command and parameter.

Multiple commands cannot be sent in a single string where a semicolon (;) is used at the end of each command.

For all commands where a parameter is supplied, a space is required between the end of the command and the first parameter. For example, `:SYST:CTYPE? 1` will work. However, `:SYST:CTYPE?1` causes a time out error.

The list of commands is split into relevant sections. In general each section corresponds to a menu option from the Main Menu.

IEEE 488.2 standard commands and status commands

*IDN?	Unit identity
Syntax	*IDN?
Returns	Tektronix, PA3000, serial number, firmware version
Description	The serial number is the serial number of the main chassis. The firmware version is the version of the firmware suite, which includes all processors.
*CLS	Clear event status
Syntax	*CLS
Description	This command clears all event registers and queues.
*ESE	Set standard event status enable register
Syntax	*ESE <flags> Where flags is the value for enable register as a decimal 0 – 255
Default	0
Description	This command sets the bits in the Standard Event Status Register that are summarized by the ESB bit in the Status Byte. The Standard Event Status Enable Register uses the same bit definitions as the Standard Event Status Register.
*ESE?	Read standard event status enable register
Syntax	*ESE?
Returns	0 – 255
Description	This command returns the value in the Standard Event Status Enable Register.
*ESR?	Read standard event status register
Syntax	*ESR?
Returns	0 – 255
Description	This command returns the value in the Standard Event Status Register. The register is cleared once it has been read.

***RST Reset device**

Syntax	*RST
Description	This command resets the unit configuration to default values (performs the same action as Load Default Configuration menu option on the front panel).

Allow at least three seconds after sending the *RST command before sending further commands to allow all defaults to be processed and set.

***STB? Read status byte**

Syntax	*STB?
Returns	0 – 255
Description	This command returns the value in the status byte.

:DSE Set Data Status Enable Register

Syntax	:DSE <flags> Where flags is the value for enable register as a decimal 0 – 255
Default	255
Description	This command sets the bits in the Data Status Enable register that are summarized by the DAS bit in the Status Byte.

:DSE? Read Data Status Enable Register

Syntax	:DSE?
Returns	0 – 255
Description	This command returns the value in the Data Status Enable register.

:DSR? Read Data Status Register

Syntax	:DSR?
Returns	0 – 255
Description	This command returns the value in the Data Status register. The Data Status Register is cleared once it has been read.

:DVC Device clear

Syntax	:DVC
Description	This command has the same affect as *RST or :CFG:USER:LOAD 0 (loading the default user configuration).

Allow at least three seconds after sending the *RST command before sending further commands to allow all defaults to be processed and set.

Channel and group commands

The following commands are used to select the active group or channel. They are similar in concept to pressing the left and right arrow keys to change the group or channel while displaying a menu screen.

:INST:NSEL Set active group

Syntax	:INST:NSEL <group number> Where <group number> is an integer between 1 and 4, depending on the number of groups available in the power analyzer
Description	This command sets the specified group as the active group for command and actions that might follow. Not affected by reset.

:INST:NSEL? Read active group

Syntax	:INST:NSEL?
Returns	<group number>
Description	This command returns the number of the group selected (between 1 and 4 depending on wiring configuration).

:INST:NSELC Select active channel

Syntax	:INST:NSELC <channel number> Where <channel number> is an integer between 1 and 4, depending on the number of channels installed in the power analyzer. Not affected by reset.
Description	This command sets the number of the channel selected (between 1 and 4) depending on number of channels installed in the power analyzer.

:INST:NSELC? Return active channel

Syntax	:INST:NSELC?
Returns	<channel number>
Description	This command returns the number of the channel selected (between 1 and 4) depending on number of channels installed.

Unit information commands

The Unit Information commands are commands that are used to return information on the unit beyond the information returned by the *IDN? command.

:CAL:DATE? Calibration date

Syntax	:CAL:DATE? <channel number>, <date type> Where <channel number> is 1 through 4 and <date type> is 1 through 2
--------	--

Returns	Appropriate calibration date in the format dd-mm-yyyy
---------	---

Description	This command returns the calibration date from the designated analog card. <date type> can be either 1 for date verified or 2 for date adjusted.
-------------	--

:SYST:CTYPE? Card type

Syntax	:SYST:CTYPE? <channel number> Where <channel number> is 0 through 4
--------	--

Returns	Tektronix, <card type>, <serial number>, <hardware revision> <card type> is either CPU for the main card, or ANALOG for a channel card. <serial number> is a 12 character string. <hardware revision> is up to four characters.
---------	--

Description	This command returns the card type, serial number and hardware revision for the designated channel. Channel 0 is the main CPU card.
-------------	---

Measurement selection and reading commands

These commands are related to selecting the required measurements and returning the results.

:SEL Select results

Syntax :SEL:ALL
 :SEL:ALL:GRP<group>
 :SEL:CLR
 :SEL:CLR:GRP<group>
 :SEL:<measurement>

Where <group> is a group number 1 through 4.
 Where <measurement> is:

VLT – Volts rms
 AMP – Amps rms
 WAT – Watts
 VAS – VA
 VAR – VAr
 FRQ – Frequency
 PWF – Power factor
 VPK+ – Volts peak (positive)
 VPK- – Volts peak (negative)
 APK+ – Amps peak (positive)
 APK- – Amps peak (negative)
 VDC – Volts DC
 ADC – Amps DC
 VRMN – Volts rectified mean
 ARMN – Amps rectified mean
 ACMN – Amps corrected rectified mean
 VCMN – Volts corrected rectified mean
 VCF – Volts crest factor
 ACF – Amps crest factor
 VTHD – Volts Total Harmonic Distortion
 VDF – Volts Distortion Factor
 VTIF – Volts Telephone Influence Factor
 ATHD – Amps Total Harmonic Distortion
 ADF – Amps Distortion Factor
 ATIF – Amps Telephone Influence Factor
 IMP – Impedance
 RES – Resistance
 REA – Reactance
 HR – Integrator time ¹
 WHR – Watt Hours ¹
 VAH – VA Hours ¹
 VRH – VAr Hours ¹
 AHR – Amp Hours ¹
 WAV – Average Watts ¹
 PFAV – Average Power Factor ¹
 CVAR – Correction VAr ¹
 VAHF – Fundamental VA-hours
 VARHF – Fundamental VAr-hours
 VF – Fundamental Volts rms
 AF – Fundamental Amps rms
 WF – Fundamental Watts

Select results (cont.)

- VAF – Fundamental VA
 - VARF – Fundamental VAR
 - PFF – Fundamental Power Factor
 - VRNG – Voltage range
 - ARNG – Current range
 - VLL – Line-to-line voltage
 - VLN – Line-to-neutral voltage
 - VHM – Volts harmonics
 - AHM – Amps harmonics
 - WHM – Watts harmonics
-

Description :SEL determines which results are displayed on the screen, also the results returned by the :FRD? command. To see the currently selected command, use the :FRF? command.

:SEL:ALL selects all results. Adding the secondary command of :GRP allow only those results within the specified group to be selected.

:SEL:CLR clears all the results selected for all groups. Adding the secondary command of :GRP allows only those results within the specified group to be cleared.

To add results to a group the :INST:NSEL <group> command must be used first. If it is not, then the last selected group will be affected (or group 1 if no group has previously been selected).

¹ These results are only available for displaying / returning when the group is in integrator mode.

:FRF? Read selected results

Syntax	<p>:FRF? :FRF:GRP<group>? :FRF:CH<channel>?</p> <p>Where <group> is a group number 1 through 4 Where <channel> is a channel number 1 through 4</p>
Description	:FRF? and :FRF:GRP? commands return a list of the displayed results. The actual result is not returned.
Returns	<p><group>, <number of measurements selected>, <number of results returned>, <measurement 1>, <measurement 2>, ..., <group>, <number of measurements selected>, ...</p> <p><number of measurements selected> is the number of measurements selected using either the front panel or the SEL command.</p> <p><number of results returned> equals the number of rows on the display used. When harmonics are selected, the number of results returned will exceed the number of measurements selected.</p> <p><measurement 1>, <measurement 2>, ... are the names of the selected measurements. The returned data will be the same as the label on the results display. For harmonics: "Vharm", "Aharm", and "Wharm" will be returned. Each returned value will be separated by a comma.</p> <p>:FRF? will return the selections for all groups.</p> <p>:FRF:CH<channel>? will return the list of results for a particular channel. This is useful for ease of measurements. The data returned for this command will be the same as ":FRF:GRP?", except the channel number will also be included. For example:</p> <p><group>, <channel>, <number of measurements selected>, <number of results returned>, <measurement 1>, <measurement 2>, ..., <group>, <channel>, <number of measurements selected>, ...</p>

:MOVE Move results

Syntax	<p>:MOVE:<measurement> <new position></p> <p>Where <measurement> is the list of measurements defined under the :SEL command. (See page 71, :SEL.)</p> <p><new position> is the position in the list of results on the screen and is in the range 1 through 51.</p>
Description	The move command is used to change the order of results on both the screen in the returned results using :FRD?. :FRF? can be used to confirm the order of results.

:FRD? Read foreground data

Syntax	<p>:FRD? :FRD:CH<ch>? :FRD:GRP<group>? Where <ch> is a channel number 1 through 4 Where <group> is a group number 1 through 4</p>
Description	<p>The commands returns results from the power analyzer. The results are returned in the order in which they are displayed on the screen. Each result is a floating point number separated by a comma.</p> <p>The sequence is determined by order in which results are displayed on the front panel. The sequence can be configured either by changing the order using the front panel of the instrument, or by using the :MOVE command.</p> <p>Results will be returned column by column starting from the left of the display. This means that if the user has selected Sum results or Max and Min results to be displayed, then these results will also be returned.</p>
Returns	<p>For :FRD:CH<ch>?, if Min or Max results are selected, these will be returned. The order will be <min>, <ch>, <max>.</p> <p>For :FRD:GRP<group>?, if Min, Max, or Sum results are selected, these will be returned. The order will be <min>, <ch>, <max>, <min>, <ch>, <max>, ..., <sum min>, <sum>, <sum max>.</p> <p>For :FRD?, each group will be returned starting with group A. The order of the results with the group will be the same as the :FRD:GRP <group>? command.</p>

Measurement configuration commands

Measurement configuration commands correspond to the Measurement Configuration menu. (See page 38, *Measurement Configuration menu*.)

:HMX:VLT/AMP/WAT Commands for configuring the display of harmonics.**Harmonics configuration**

Syntax	<p>:HMX:VLT:SEQ <value> :HMX:AMP:SEQ <value> :HMX:WAT:SEQ <value> Where <value> equals 0 for odd and even and 1 for odd only</p>
Description	<p>If harmonics measurements are selected with the :SEL command (See page 71.), the power analyzer can display all harmonics, or just the odd number harmonics from the first harmonic up to the number specified.</p> <p>This command works on a group. Use the :INST:NSEL command first to select the active group.</p>

Harmonics configuration (cont.)

Syntax	<p>:HMX:VLT:RNG <value> :HMX:AMP:RNG <value> :HMX:WAT:RNG <value></p> <p>Where <value> is the maximum harmonic to be display in the range of 1 to 100</p>
Description	<p>If harmonics measurements are selected with the :SEL command (See page 71.), the power analyzer will display all the harmonics up to the number specified by <value>. The displayed harmonics can be restricted to only odd numbered harmonics using the harmonic sequence command.</p> <p>This command works on a group. Use the :INST:NSEL command first to select the active group.</p>
Syntax	<p>:HMX:VLT:FOR <value> :HMX:AMP:FOR <value> :HMX:WAT:FOR <value></p> <p>Where <value> is 0 for absolute values or 1 for percentage values</p>
Description	<p>If harmonics measurements are selected with the :SEL command (See page 71.), the power analyzer can display all harmonics (except the first) as an absolute value or as a percentage of the fundamental (first) harmonic.</p> <p>This command works on a group. Use the :INST:NSEL command first to select the active group.</p>

:HMX:VLT/AMP:DF Commands for setting up the distortion factor measurements.

Distortion factor setup

Syntax	<p>:HMX:VLT:DF:REF <value> :HMX:AMP:DF:REF <value></p> <p>Where <value> is 0 for fundamental or 1 for rms</p>
Description	<p>For distortion factor readings (also known as the difference formula), the reference on the denominator of the equation can be either the rms reading or the fundamental harmonic reading.</p> <p>This command works on a group. Use the :INST:NSEL command first to select the active group.</p>

:HMX:VLT/AMP:PHA **Display phase angle**

Syntax :HMX:AMP:PHA <value>
 :HMX:VLT:PHA <value>
 Where <value> is 0 for on or 1 for off

Description This command turns the display of the voltage or current phase angle on or off (default On).

Syntax :HMX:AMP:PHA?
 :HMX:VLT:PHA?

Returns 0 or 1

:HMX:VLT/AMP:THD **Commands for setting up the total harmonic distortion measurements.****Total harmonic distortion setup**

Syntax :HMX:VLT:THD:REF <value>
 :HMX:AMP:THD:REF <value>
 Where <value> is 0 for fundamental or 1 for rms

Description For total harmonic distortion (THD) readings (also known as the series formula), the reference on the denominator of the equation can be either the rms reading or the fundamental harmonic reading.
 This command works on a group. Use the :INST:NSEL command first to select the active group.

Syntax :HMX:VLT:THD:SEQ <value>
 :HMX:AMP:THD:SEQ <value>
 Where <value> is 0 for odd and even or 1 for odd only

Description For total harmonic distortion (THD) readings, the harmonics used in the measurement can include all harmonics up to the specified number or only the odd harmonics.
 This command works on a group. Use the :INST:NSEL command first to select the active group.

Syntax :HMX:VLT:THD:RNG <value>
 :HMX:AMP:THD:RNG <value>
 Where <value> is the maximum harmonic to display in the range of 2 to 100.

Description For total harmonic distortion (THD) readings, <value> specifies the maximum harmonic number used in the formula.
 This command works on a group. Use the :INST:NSEL command first to select the active group.

Total harmonic distortion setup (cont.)

Syntax	:HMX:VLT:THD:NZ <value> :HMX:AMP:THD:NZ <value> Where <value> is 0 for exclude or 1 for include
Description	For total harmonic distortion (THD) readings, the formula can either include or exclude the DC component. This command works on a group. Use the :INST:NSEL command first to select the active group.

:HMX:VLT/AMP:TIF Telephone influence factor setup

Syntax	:HMX:VLT:TIF:REF <value> :HMX:AMP:TIF:REF <value> Where <value> is 0 for fundamental or 1 for rms
Description	For telephone influence factor readings, the reference on the denominator of the equation can be either the rms reading or the fundamental harmonic reading. This command works on a group. Use the :INST:NSEL command first to select the active group.

:MIN Minimum column

Syntax	:MIN <value> Where <value> is 0 for disabled or 1 for enabled
Description	The MIN command adds a column to the results that displays the minimum value of each parameter since the last time the minimum values were reset. A column is added for each channel in the group, as well as for sum results, if they are selected. Enabling the column will always reset the MIN and MAX values for the currently selected group. The values can also be reset by using the :RES command or pressing the RESET/CLEAR key on the front panel. To reset the MIN hold values, send the command :MIN 1 to re-enable the column. Note that both MIN and MAX hold values will be reset. This command works on a group. Use the :INST:NSEL command first to select the active group.
Syntax	:MIN?
Returns	0 or 1
Description	This command returns the status of the minimum value column. A 0 will be returned if disabled; a 1 if enabled. This command works on a group. Use the :INST:NSEL command first to select the active group.

:MAX Maximum column

Syntax	<code>:MAX <value></code> Where <value> is 0 for disabled or 1 for enabled
Description	<p>The MAX command adds a column to the results that displays the maximum value of each parameter since the last time the maximum values were reset. A column is added for each channel in the group, as well as for sum results, if they are selected.</p> <p>Enabling the column will always reset the MIN and MAX values for the currently selected group. The values can also be reset by using the :RES command or pressing the RESET/CLEAR key on the front panel.</p> <p>To reset the MAX hold values, send the command :MAX 1 to re-enable the column. Note that both MIN and MAX hold values will be reset.</p> <p>This command works on a group. Use the :INST:NSEL command first to select the active group.</p>
Syntax	<code>:MAX?</code>
Returns	0 or 1
Description	<p>This command returns the status of the maximum value column. A 0 will be returned if disabled; a 1 if enabled.</p> <p>This command works on a group. Use the :INST:NSEL command first to select the active group.</p>

:SUM Sum results

Syntax	<code>:SUM <value></code> Where <value> is 0 for disabled or 1 for enabled
Description	<p>The command adds a column to the results that displays the sum values of each parameter selected (where applicable) for a group. This command works on a group. Use the :INST:NSEL command first to select the active group. If the currently selected groups wiring mode is 1 phase, 2 wire, then a request to add sum results will be ignored.</p>
Syntax	<code>:SUM?</code>
Returns	0 or 1
Description	<p>This command returns the status of the sum results column. A 0 will be returned if disabled; a 1 if enabled.</p> <p>This command works on a group. Use the :INST:NSEL command first to select the active group.</p>
Syntax	<code>:SUM:AMP:METHD <method></code> <code>:SUM:VLT:METHD <method></code> Where <method> is 1 or 2 to select the summation method
Description	<p>These commands select the summation method used for the Min, Max, and Sum columns. Refer to the sum equations later in this document. (See page 142, <i>Sum equations</i>.)</p>

Sum results (cont.)

Syntax	:SUM:AMP:METHD? :SUM:VLT:METHD?
Returns	The summation method (1 or 2)

Mode setup commands

The mode setup commands correspond to the Modes menu. (See page 42, *Modes*.) They are used to control how groups are configured to measure parameters in certain conditions.

:MOD Mode

Syntax	:MOD:NOR (normal mode) :MOD:BALL (ballast mode) :MOD:SBY (standby power mode) :MOD:INT (integrator mode) :MOD:PWM (PWM Motor mode)
Description	This command will set the mode for the group. Because this command works with a group, use the :INST:NSEL command first to select the active group.
Syntax	:MOD?
Returns	Mode number from 0 to 4
Description	This command will return a reference to mode for the active group. Because this command works with a group, use the :INST:NSEL command first to select the active group. The returned values are: 0 – Normal Mode 1 – Ballast Mode 2 – Standby Power Mode 3 – Integrator Mode 4 – PWM Motor Mode

:MOD:BALL Ballast mode

Syntax	:MOD:BALL:FREQ <value> Where <value> is the power frequency in the range of 45 to 1000 Hz
Description	This command sets the power frequency for ballast mode. (See page 42, <i>Ballast mode</i> .) Because this command works with a group, use the :INST:NSEL command first to select the active group.
Syntax	:MOD:BALL:FREQ?

Ballast mode (cont.)

Returns	Ballast frequency for the selected group
Description	This command returns the ballast frequency for the active group.

:MOD:SBY Standby mode

Syntax	:MOD:SBY:PER <value> Where <value> is the standby power integration period in the range of 1 to 1200 seconds as an integer
Description	This command will set the integration period for standby power mode. (See page 43, <i>Standby Power mode</i> .) Because this command works with a group, use the :INST:NSEL command first to select the active group.
Syntax	:MOD:SBY:PER?
Returns	Integration period for the selected group
Description	This command returns the integration period for the active group.

:MOD:INT Integrator mode

Syntax	:MOD:INT:ST:METH <method> Where <method> 0 – manual 1 – clock 2 – level Because the integrator is a group function, use the :INST:NSEL command first to select the active group.
Description	This command sets the starting method for the integrator.
Syntax	:MOD:INT:ST:CLK:TIME <time> Where <time> is either hh:mm:ssA/P or hh:mm:ss
Description	This command sets the integrator start time when used in clock start method. The data in input is in the same format as the user has requested.
Syntax	:MOD:INT:ST:CLK:DATE <date> Where <date> is in one of the following formats: ■ dd:mm:yyyy or mm:dd:yyyy or yyyy:mm:dd ■ dd/mm/yyyy or mm/dd/yyyy or yyyy/mm/dd ■ dd-mm-yyyy or mm-dd-yyyy or yyyy-mm-dd
Description	This command sets the integrator start date when used in clock start method. The data in input is in the same format as the user has requested.
Syntax	:MOD:INT:ST:LVL:CH <channel> Where <channel> is 1 through 4

Integrator mode (cont.)

Description	This command sets the channel to use for level trigger. Specified as 1, 2, 3, or 4. If the channel number is not valid, then the ESR bit will be set.
Syntax	:MOD:INT:ST:LVL:SIG: <measurement> Where <measurement> is the measurement is: VLT – Volts rms AMP – Amps rms WAT – Watts VAS – VA VAR – VAR FRQ – Frequency PWF – Power factor VPK+ – Volts peak (positive) VPK- – Volts peak (negative) APK+ – Amps peak (positive) APK- – Amps peak (negative) VDC – Volts DC ADC – Amps DC VRMN – Volts rectified mean ARMN – Amps rectified mean VCF – Volts crest factor ACF – Amps crest factor VTHD – Volts Total Harmonic Distortion VDF – Volts Distortion Factor VTIF – Volts Telephone Influence Factor ATHD – Amps Total Harmonic Distortion ADF – Amps Distortion Factor ATIF – Amps Telephone Influence Factor IMP – Impedance RES – Resistance REA – Reactance AI1 - Analog input 1 AI2 - Analog input 2 AI3 - Analog input 3 AI4 - Analog input 4
Description	This command sets the signal to be monitored for comparison against the threshold. The command is followed by the normal signal selection parameter such as VRMS or PWF.
Syntax	:MOD:INT:ST:LVL:SIG?
Description	This command returns the numerical identifier of the selected measurement.
Syntax	:MOD:INT:ST:LVL:THRES <threshold>
Description	This command sets the threshold level, a floating point number from $\pm 1e9$
Syntax	:MOD:INT:ST:LVL:DIR <direction> Where <direction> is 0 for \geq and 1 for \leq

Integrator mode (cont.)

Description	This command sets the direction of signal change when using level trigger start.
Syntax	:MOD:INT:DUR <duration> Where <duration> is the time in minutes
Description	This command sets the duration for integration, a value of 0.0 to 10,000.
Syntax	:MOD:INT:PF <power factor> Where <power factor> is the desired power factor
Description	This command sets the desired power factor for correction VARs, a value of +1.0 to -1.0.
Syntax	:MOD:INT:RUN
Description	This command starts integration on all integrators.
Syntax	:MOD:INT:STOP
Description	This command stops integration on all running integrators.
Syntax	:MOD:INT:RESET
Description	This command resets integration on all integrators.

:MOD:PWM

NOTE. *There are no specific PWM Motor mode commands other than the normal :MOD:PWM command to select PWM Motor mode.*

Input setup commands

The input setup commands correspond to the Inputs menu. (See page 47, *Inputs*.) They are used to control how signal inputs to the PA3000 are channelled and controlled.

:WRG Wiring configuration

Syntax	:WRG:1P2 - Set 1 phase, 2 wire :WRG:1P3 - Set 1 phase, 3 wire :WRG:3P3 - Set 3 phase, 3 wire :WRG:3P4 - Set 3 phase, 4 wire :WRG:3P3V3A - Set 3 phase, 3 wire (3V3A)
Description	This command sets up the wiring configuration for the group currently selected. Use the :INST:NSEL command first to select the active group.
Syntax	:WRG?
Returns	0, 1, 2, 3, or 4 Each value represents a wiring configuration: 0 is 1p2w 1 is 1p3w 2 is 3p3w 3 is 3p4w 4 is 3p3w (3V3A)

:NAME Group name

Syntax	:NAME <value> Where <value> is the group name
Description	This command will set the display name for the group. The limit is eight characters, per group name. Because this command works with a group, use the :INST:NSEL command first to select the active group.
Syntax	:NAME?
Returns	Group name up to eight characters
Description	This command will return the display name for the active group. Because this command works with a group, use the :INST:NSEL command first to select the active group.

:RNG Ranging

Syntax :RNG:VLT:FIX <range>
 :RNG:AMP:FIX <range>
 :RNG:VLT:AUT
 :RNG:AMP:AUT
 VLT – set voltage ranging
 AMP – set current ranging
 FIX – fixed ranging
 AUT – auto ranging
 Where <range> is the range number from 4 to 12

Description This command sets the range for the currently selected group, Use the :INST:NSEL command first to select the active group.
 The range numbers for each input are defined in the following table.

Range #	Volts	30 A shunt	1 A shunt	External shunt
Auto				
4	5 V	0.5 A	0.0125 A	0.05 V
5	10 V	1 A	0.025 A	0.1 V
6	20 V	2 A	0.05 A	0.2 V
7	50 V	5 A	0.125 A	0.5 V
8	100 V	10 A	0.25 A	1 V
9	200 V	20 A	0.5 A	2 V
10	500 V	50 A	1.25 A	5 V
11	1000 V	100 A	2.5 A	10 V
12	2000 V	200 A	5 A	20 V

Syntax :RNG:VLT?
 :RNG:AMP?

Returns 0 through 12

Description This command returns the range configuration that applies to the currently selected group. If the currently selected group is in auto-range, then 0 will be returned.

Syntax :RNG:VLT:AUT?
 :RNG:AMP:AUT?

Returns 0 through 12

Description This command is linked to a channel, not a group. It returns the actual range that the currently selected channel is in. When there are multiple channels in a group, and the group is set to auto range, each channel will find the best range for signals applied.
 Use the :INST:NSELC command first to select the active channel.

:SHU Shunt selection

Syntax	:SHU:INT :SHU:INT1A :SHU:EXT INT – set internal 30 A _{rms} shunt INT1A – set internal 1 A _{rms} shunt EXT – set external shunt
Description	This command sets the shunt for all channels in the currently selected group. Use the :INST:NSEL command first to select the active group.
Syntax	:SHU?
Returns	0, 1, or 2
Description	This command returns the shunt setting for the currently selected group. 0 – Internal 30 A _{rms} shunt 1 – Internal 1 A _{rms} shunt 2 – External shunt Use the :INST:NSEL command first to select the active group.

:FSR Frequency settings

Syntax	:FSR:VLT :FSR:AMP :FSR:EXT1 :FSR:EXT2 VLT – set voltage channel as the source. INT1A – set current channel as the source. EXT1 – set external counter input 1 as the source. EXT2 – set external counter input 2 as the source.
Description	This command sets the frequency source for the currently selected group. The first channel in the group determines the frequency. Use the :INST:NSEL command first to select the active group.
Syntax	:FSR?
Returns	0, 1, 2, or 3
Description	This command returns the currently configured frequency source for the selected group. The values returned correspond to: 0 – Voltage channel 1 – Current channel 2 – External counter input 1 3 – External counter input 2 Because this command works with a group, use the :INST:NSEL command first to select the active group.

Frequency settings (cont.)

Syntax	:FSR:PHR:VLT - Set the voltage channel as the reference. :FSR:PHR:AMP - Set the current channel as the reference.
Description	These commands set the phase reference for the group to be either the voltage or the current channel of the first card in the group. The commands work on a group. Use the :INST:NSEL command first to select the active group.
Syntax	:FSR:PHR?
Returns	0 or 1
Description	This command returns the currently configured phase reference for the selected group. The values returned correspond to: 0 – Voltage channel 1 – Current channel Because this command works with a group, use the :INST:NSEL command first to select the active group.
Syntax	:FSR:RNG <value> Where <value> is 0 through 2
Description	This command sets the frequency range allowed for the input signal. The values correspond to: 0 – >10 Hz 1 – 1 Hz to 100 Hz 2 – 0.1 Hz to 10 Hz This command works on a group. Use the :INST:NSEL command first to select the active group.
Syntax	:FSR:RNG?
Returns	0, 1, or 2
Description	This command returns the currently configured frequency range for the selected group. The values returned correspond to: 0 – >10 Hz 1 – 1 Hz to 100 Hz 2 – 0.1 Hz to 10 Hz Because this command works with a group, use the :INST:NSEL command first to select the active group.

:BDW Bandwidth

Syntax	:BDW <value> Where <value> is 0 or 1
Description	This command sets the bandwidth of all voltage and current measurement channels in the active group. 0 = high bandwidth and 1 = low bandwidth. Low bandwidth mode introduces a 10 kHz 2-pole filter into the voltage and current measurement channels.
Syntax	:BDW?
Returns	0 or 1
Description	This command returns the currently configured bandwidth for the selected group. The values returned correspond to: 0 – High bandwidth 1 – Low bandwidth Because this command works with a group, use the :INST:NSEL command first to select the active group.

:SCL Scaling

Syntax	:SCL:VLT <scale> :SCL:AMP <scale> :SCL:EXT <scale> :SCL:VLT:GRP <scale> :SCL:AMP:GRP <scale> :SCL:EXT:GRP <scale> VLT – Voltage channel scaling AMP – Current channel scaling EXT – External shunt scaling Where <scale> is a number from 0.00001 to 100000
Description	This command sets the scaling factor for the currently selected channel. Use the :INST:NSELC command first to select the active channel. If the GRP option is used the same scaling factor will be applied to all channels in the group. Use the :INST:NSEL command first to select the active group before using the GRP option.
Syntax	:SCL:VLT? :SCL:AMP? :SCL:EXT? VLT – Voltage channel scaling AMP – Current channel scaling EXT – External shunt scaling

Scaling (cont.)

Returns	A number from 0.00001 to 100000
Description	This command is linked to a channel, not a group. It returns the scaling factor for the currently selected channel. Use the :INST:NSEL command first to select the active channel.

:ANA Analog inputs

Syntax	:ANA <input>, <range> Where <input> is an input number 1 through 4 and <range> = 1 or 10
Description	This command sets the analog inputs 1 through 4. If <range> is 1, then the ± 1 V range is selected. If <range> is 10, then the ± 10 V range is selected for the specified input.
Syntax	:ANA? <input> Where <input> is an input number 1 through 4.
Returns	The measured analog signal on the selected input

Graph and waveform commands**:WAV Waveform graphs**

Syntax	:WAV:VLT <enable> :WAV:AMP <enable> :WAV:WAT <enable>
Description	These commands enable or disable the display of a waveform graph, where <enable> is 1 to enable or 0 to disable. The commands are all channel based commands. Select the channel with :INST:NSEL before using these commands.
Syntax	:WAV:VLT? :WAV:AMP? :WAV:WAT?
Description	These commands return the enable or disable status of the waveform graph display. The commands are all channel based commands. Select the channel with :INST:NSEL before using these commands.
Returns	1 if the waveform is enabled or 0 if the waveform is not enabled.

Interface commands

Interface commands are used to set up and control the various ways of communicating with the power analyzer.

:COM:RS2 RS-232 configuration

Syntax :COM:RS2:BAUD <baud rate>
Where <baud rate> is a baud rate of 9600, 19200, or 38400

Description This command sets the RS-232 baud rate.

Syntax :COM:RS2:BAUD?

Returns Baud rate of 9600, 19200 or 38400

:COM:IEE GPIB configuration

Syntax :COM:IEE:ADDR <address>
Where <address> is an address in the range of 1 to 30

Description This command sets the GPIB address for the PA3000.

Syntax :COM:IEE:ADDR?

Returns The GPIB address for the power analyzer. If -1 is returned, no GPIB card is installed.

:COM:ETH Return Ethernet configurations

Syntax :COM:ETH:SUB?
:COM:ETH:IP?
:COM:ETH:GATE?
SUB – Subnet mask
IP – IP address
GATE – Default gateway

Returns Number in the form of v4 IP address xxx.xxx.xxx.xxx

Description This command returns the requested information in the form of an IP address. The information returned is the current configuration. If DHCP is used as the assignment method, then the values returned would be those values assigned by the DHCP server.

:COM:ETH:STAT Static Ethernet configuration

Syntax :COM:ETH:STAT <value>
Where <value> is 0 or 1

Description This command determines whether the power analyzer uses a static IP address or one assigned by a DHCP server. If <value> = 0 then a DHCP server is used. If <value> = 1 then the static IP settings are used.

Static Ethernet configuration (cont.)

Syntax	:COM:ETH:STAT?
Returns	0 or 1
Syntax	:COM:ETH:STAT:SUB <ip value> :COM:ETH:STAT:IP <ip value> :COM:ETH:STAT:GATE <ip value> SUB – Subnet mask IP – P address GATE – Default gateway Where <ip value> is in the format xxx.xxx.xxx.xxx
Description	These commands set the assigned static IP values for the power analyzer.
Syntax	:COM:ETH:STAT:SUB? :COM:ETH:STAT:IP? :COM:ETH:STAT:GATE? SUB – Subnet mask IP – IP address GATE – Default gateway
Returns	The IP address in the format xxx.xxx.xxx.xxx.

:COM:ETH:MAC

Ethernet MAC Address

Syntax	:COM:ETH:MAC?
Returns	MAC address in the format of 12 hexadecimal characters
Description	This command returns the MAC address on the Ethernet controller. The MAC address would be of the form: 0x0019B9635D08.

Datalog commands

The datalog commands produce the same functionality as the Datalog menu and as the DATA OUT key on the front panel.

:DATA:USB

USB Data logging

Syntax	:DATA:USB <stop/start> Where <stop/start> 0 = stop; 1 = start
Description	This command has the same function as pressing the DATA OUT key. If a USB flash drive is present, it will log data to the flash drive.

Screen save commands

:DISP:DATA? Display data

Syntax	:DISP:DATA?
Description	The command freezes the display and returns a bitmap image of the screen. Once the transfer is complete the display will update normally. The binary data is the contents of a .bmp file and can be written directly to a file on a host computer.
Returns	This command returns a bitmap image as an IEEE 488.2 <DEFINITE LENGTH ARBITRARY BLOCK RESPONSE DATA> formatted response.

Math commands

The math commands enable setting up the math screen on the power analyzer, as well as the returning the results.

:MATH:FUNC Math function information

Syntax	:MATH:FUNC <funcNumber>, <name>, <formula>, <unit> Where <funcNumber> = 1 through 30 <name> – user visible name <formula> – formula for math function <unit> – units to be displayed
Returns	1 if successful, otherwise 0.
Description	This command configures the specified math function.
Syntax	:MATH:FUNC? <funcNumber> Where <funcNumber> is a valid math function number between 1 and 30
Returns	<name>,<formula>,<unit> Where <name> – user visible name <formula> – formula for math function <unit> – units to be displayed
Description	This command will return the math function name, formula, and units for the function.

:MATH:FUNC:EN Math function enable

Syntax	:MATH:FUNC:EN <funcNumber>, <enable> Where <funcNumber> is a valid math function number between 1 and 30 <enable> is 1 to enable the display of the function and 0 to disable it.
Description	This command will enable or disable math function in the Math screen.

Math function enable (cont.)

Syntax	:MATH:FUNC:EN? <funcNumber> Where <funcNumber> is a valid math function number between 1 and 30
Description	This command returns the status of whether a math function is enabled (1) or disabled (0).

:MATH? Return MATH results

Syntax	:MATH?
Description	This command returns all the calculated math functions that are enabled in a comma-separated string.

System configuration commands

The System configuration commands correspond to the System Configuration menu screen. (See page 59, *System Configuration*.)

:BLK Blanking

Syntax	:BLK:ENB – blanking enabled :BLK:DIS – blanking disabled
Description	With blanking enabled, the power analyzer returns a zero when the measured signal is less than 5% of the range for the selected channel. If the blanked channel is also used in another result, such as, Watts, then that value will also be blanked.
Syntax	:BLK?
Returns	ENB if enabled, DIS if disabled
Description	This command returns the status of blanking.

:AVG Averaging

Syntax	:AVG:AUT <depth> Where <depth> is 1 through 10
Description	The command sets the depth of the averaging buffer to average up to <depth> sample periods. The sample period can also be changed using the :UPDATE command. The averaging buffer will be reset whenever there is a range change or the signal changes by more than 20%. The command will also set the depth of the auxiliary inputs to the same value.
Syntax	:AVG?
Description	This command returns the averaging value as an integer.
Syntax	:AVG:CH <depth>

Averaging (cont.)

Description	The command sets the averaging depth of the selected channel. The sample period can also be changed using the :UPDATE command. The averaging buffer will be reset whenever the signal changes by more than 20% of the average.
Syntax	:AVG:CH?
Description	This command returns the averaging value as an integer.
Syntax	:AVG:AUX <depth> Where <depth> is 1 through 10
Description	The command exclusively sets the depth of the auxiliary inputs averaging buffer to average up to <depth> sample periods. The sample period can also be changed using the :UPDATE command. The averaging buffer will be reset whenever the signal changes by more than 2% of the average.
Syntax	:AVG:AUX?
Description	This command returns the averaging value of the auxiliary inputs as an integer.

:UPDATE Update rate

Syntax	:UPDATE <update rate> Where <update rate> is 0.05, 0.1, 0.2, 0.5, 1.0, or 2.0 seconds
Description	This command changes the display update rate. If the update rate is set to less than 0.5 seconds, then the number of harmonics returned in the update period will be reduced.
Syntax	:UPDATE?
Description	This command returns the update rate as a floating point number.

:SYST:ZERO Autozero

Syntax	:SYST:ZERO <value> Where <value> is 0 for disable, 1 for enable, or 2 to run immediately
Description	This command sets whether the autozero function for the channels is enabled or disabled.
Syntax	:SYST:ZERO?
Description	This command returns the autozero function for the channels. 0 if the function is disabled or 1 if the function is enabled.

:SYST:DATE **System date**

Syntax `:SYST:DATE?`
 `:SYST:DATE:SET <date value>`
 `:SYST:DATE:FORMAT <date format>`
 Where <date value> is the new date in the selected format and <date format> is the date format

Returns Date formatted in the way specified by the user separated by forward slashes (/)

Description The `:SYST:DATE?` command returns the date on the power analyzer.
 The `:SYST:DATE:SET` command sets the date on the power analyzer. The <date value> should be in the format specified by the `:SYST:DATE:FORMAT` command. For example, if the specified format were 0 (mm/dd/yyyy), then the command would be: `:SYST:DATE:SET 12/31/2015`.
 Use one of the three formats with the `:SYST:DATE:FORMAT` command:
 <date format> = 0 – mm/dd/yy or mm:dd:yyyy or mm-dd-yyyy
 <date format> = 1 – dd/mm/yy or dd:mm:yyyy or dd-mm-yyyy
 <date format> = 2 – yyyy/mm/dd or yyyy:mm:dd or yyyy-mm-dd

:SYST:TIME **System time**

Syntax `:SYST:TIME?`
 `:SYST:TIME:SET <time value>`
 `:SYST:TIME:FORMAT <time format>`
 Where <time value> is the new time in the selected format and <time format> is the time format

Returns The time will be in either 12-hour or 24-hour format in hours and minutes and seconds separated by colons (:). For example, 01:34:22P for 12 hour or 13:34:22 for 24 hour.

Description The `:SYST:TIME?` command returns the time on the power analyzer in the specified format. The time can be in one of two formats:
 <time format> = 0 – 12 Hour hh:mm:ssA/P
 <time format> = 1 – 24 Hour hh:mm:ss
 The time can also be set on the power analyzer using the `:SYST:TIME:SET` command. In this case, the <time value> should be in the format specified. For example, if the specified format were 0 (12 Hour), then the command would be:
`:SYST:TIME:SET 08:32:20P`
 For 12 hour clock, A should be used for AM and P for PM.

:SYST:POWER Power usage

Syntax	<code>:SYST:POWER:DISP <value></code> Where <value> is 0, 1, or 2
Description	This command allows the display to be switched off to reduce the power consumption of the power analyzer. The operation of the display is determined by the following values: 0 – always on 1 – off after 10 minutes with no key press nor remote control 2 – off in remote control mode
Syntax	<code>:SYST:POWER:DISP?</code>
Returns	0 – always on 1 – off after 10 minutes with no key press nor remote control 2 – off in remote control mode

User configuration commands

These commands relate to the User Configuration menu item.

:CFG:USER User configurations

Syntax	<code>:CFG:USER:LOAD <value></code> <code>:CFG:USER:SAVE <value></code> Where <value> is user configuration 1 through 8 for saving and 0 through 8 for loading. 0 is the default configuration.
Returns	1 for success or 0 for failure
Description	These commands will be used to load and save one of the user configurations.
Syntax	<code>:CFG:USER:REN <value>, <config.Name></code> Where <value> is user configuration 1 through 8 and <config.Name> is a new configuration name (up to 16 characters)
Description	This command changes the name of the configuration to aid in finding it again. Tip: When saving or loading configurations, allow at least three seconds after sending the <code>:CFG:USER:LOAD <value></code> command before reading a 1 for success, or 0 for failure.

Sending and receiving commands

There are many ways in which to send commands to the PA3000, but there are some common rules for all methods:

- All instructions should be terminated with a line feed (ASCII 10) character.
- All returned information will be terminated by a line feed (ASCII 10) character.
- Only one instruction can be sent at a time. For example, `:SEL:VLT;:SEL:AMP` is not a valid command.
- For all commands that configure the unit, allow 0.5 seconds between each command or use flow control to wait until the next command is sent.
- The running of autozero, which happens every minute, results in no new results for approximately one second. For this reason autozero can be disabled.

NOTE. *When using communications through the Ethernet interface on the power analyzer, all communications will be responded to with a line feed character, such as, ASCII LF(0x0A). In the examples below the line feed character is represented by “[LF]”.*

Tip. If using Visual Studio or LabVIEW, use the Flush, In-buffer command to quickly remove the carriage return from the input buffer. This can be set up as a discipline in the software to occur after every read and write command sent.

Example 1. Send a query to the power analyzer to determine the status of the shunt. The power analyzer will respond with a LF added to the end of the string;

USER: “:SHU?”

Power analyzer: “0[LF]”

The power analyzer responds as normal with a LF character added to the end of the string.

Example 2. User sends a command to the power analyzer to disable blanking and the power analyzer responds with a LF character;

USER: “:SHU:INT”

Power analyzer: “[LF]”

The power analyzer responds with a LF character.

Using all other communication methods, the power analyzer does not reply with a LF to every communication.

Communications examples

Basic selection and returning of results

The results are returned using the FRD command. This returns the results that are shown on the screen, in the order in which they appear on the screen. As results are selected using remote control, the results are added to the bottom of the list, with the exception of harmonics, which always appear at the end of the list.

<code>:INST:NSEL 1</code>	Sets the current group as group 1
<code>:SEL:CLR</code>	Clears all results from all groups
<code>:SEL:VLT</code>	
<code>:SEL:AMP</code>	
<code>:SEL:FRQ</code>	
<code>:SEL:WAT</code>	
<code>:SEL:VAS</code>	
<code>:SEL:VAR</code>	
<code>:SEL:PWF</code>	
<code>:SEL:VPK+</code>	
<code>:SEL:APK+</code>	
<code>:FRD?</code>	Returns V_{rms} , A_{rms} , Frequency, Watts, VA, VA_r , power factor, V_{pk+} and V_{pk-} in floating point format.
<code>:FRF?</code>	Returns the results selected for confirmation using the label that appears on the display. In this case will return, "Vrms, Arms, Freq, Watt, VA, VAR, PF, Vpk+, Apk+"

Returning results repeatedly

The power analyzer updates the results at the specified update rate. To return results as soon as they are available, set up the DSE register to enable bit 1, the New Data Available (NDV) bit. Then read the DSR register using the ":DSR?" command until it indicates that there is new data available, and then send a ":FRD?" command to get selected results.

```
:DSE 2 // This enables the NDV bit.
while strDSR <> "2"
    :DSR?
    strDSR = received data
Loop
:FRD?
Receive results
```

Harmonics

To return harmonics, first the number of harmonic and the scope need to be selected and then they need to be added to the list of results on the display.

:HMX:VLT:SEQ 0	Select odd and even harmonics (use 1 to select odd harmonics only).
:HMX:VLT:RNG 9	Return all harmonics from 1 to 9.
:SEL:VHM	Add Voltage harmonics to the list.

Now, assuming :SEL:CLR has not been issued after example 1, then the following results would be returned by :FRD?

V_{rms} , A_{rms} , Freq, Watt, VA, VA_r , PF, V_{pk+} , A_{pk+} , V_{h1Mag} , V_{h1Ph} , V_{h2Mag} , V_{h2Ph} , ..., V_{h9Mag} , V_{h9Ph} .

Communication example using a group of channels

Example showing a full sequence of commands used to communicate with a group of channels. This example will use the 1 A shunt and will blank below 5% of the range.

*RST	Reset the instrument to default values.
*IDN?	Identify the instrument and returns a string that can be used by the user in the software "Tektronix, PA3000, Serial Number, Firmware Version".
:INST:NSEL 1	Select group 1.
:WRG:3P3	Set Channel 1 and Channel 2 for 3 phase 3 wire setup as part of group 1.
:RNG:VLT:AUT	Set voltage auto ranging.
:RNG:AMP:AUT	Sets current auto ranging.
:SHU:INT1A	Set the 1A shunt for current measurements.
:FSR:VLT	Set voltage as the frequency source.
:BLK:ENB	Enable blanking.
:AVG:AUT 5	Set the measurements average to 5.
:SEL:CLR	Clear the measurement selection list.
:SEL:VLT	Select V_{rms} .
:SEL:WAT	Select watts power.
:SEL:AMP	Select A_{rms} .
:SEL:FRQ	Select frequency.
:SEL:PWF	Select power factor.
:SEL:VAS	Select VA power.
{ }	
{ Any additional parameters such as harmonics enter here. (See page 98, Harmonics.) }	
{ }	
:DSE 3	Set DSR when data is available.

<code>while dsr <> 3</code>	Poll in a continuous loop until DSR = 3.
<code>:DSR?</code>	
<code>Loop</code>	
<code>:FRD:GRP1?</code>	Read the measured data, which will be shown as follows in floating point format: V_{rms} , Watts, A_{rms} , Freq, Power Factor, VA Power, V_{rms} , Watts, A_{rms} , Freq, Power Factor, VA Power.

PA3000 software

PWRVIEW PC software

PWRVIEW is a supporting software application for Windows PCs that compliments and extends the functionality of the power analyzer.

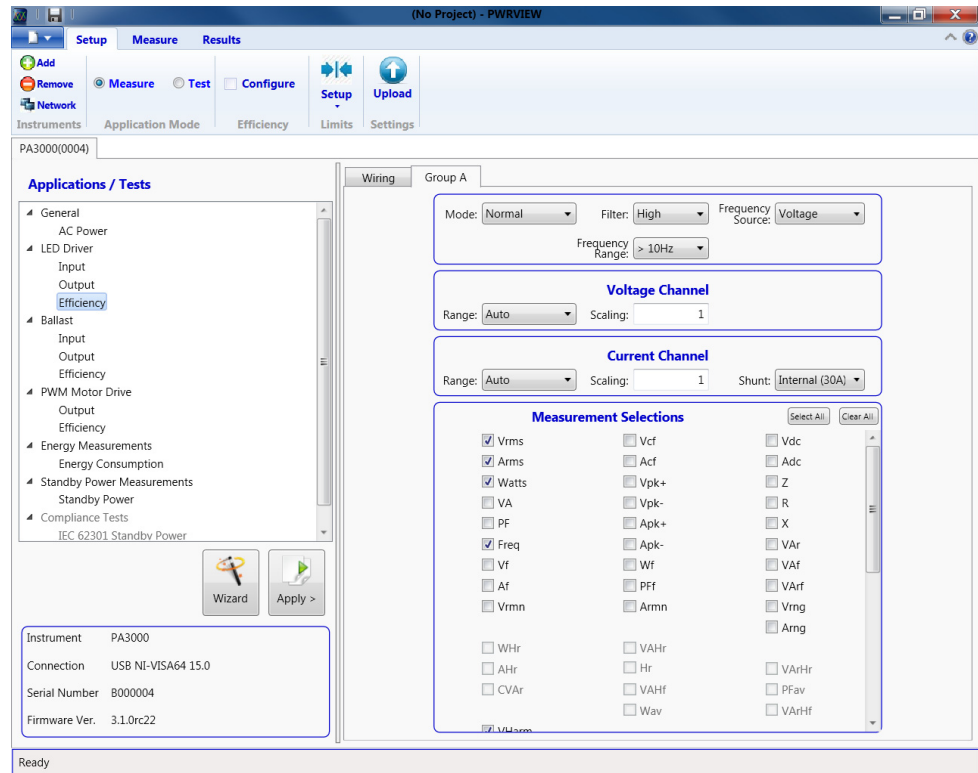

Figure 37: PWRVIEW software

PWRVIEW is a free download from www.tek.com that enables you to do the following:

- Communicate with the power analyzer over any of the available instrument communication ports
- Change instrument settings remotely
- Transfer, view, and save measurement data in real-time from the instrument, including waveforms, harmonic bar charts, and plots
- Log measurement data over a period of time
- Communicate with and download data from multiple Tektronix power analyzers simultaneously

- Create and log formulas for the calculation of power conversion efficiency and other values
- Export measurement data to .csv or .xls format for import into other applications
- Automate instrument setup, data collection, and report generation for key applications with just a few clicks, using wizard-driven interfaces
- Perform automated full compliance testing for Low Power Standby per IEC 62301 Ed. 2.0
- Perform automated pre-compliance testing for current harmonics per IEC 61000-3-2:2014 Ed. 4 and IEC 610004-7-:2002 + A1:2009. (Only currently available with a PA1000 Power Analyzer)
- Set user-defined limits

Several application examples using the power analyzer and the PWRVIEW software are provided in this document. (See page 103, *Application examples*.) Use these examples to become more familiar using the power analyzer by itself or with PWRVIEW software. A PDF version of the PWRVIEW online help is available for download at www.tek.com.

Firmware update utility

The PA3000 has been designed to add new features by updating the firmware within the product. The firmware is updated by using a free PC software program. This program can be found under the PA3000 section of the Tektronix Web site (www.tek.com). Download the software and install it on your PC.

Once installed, run the software to get the main screen:

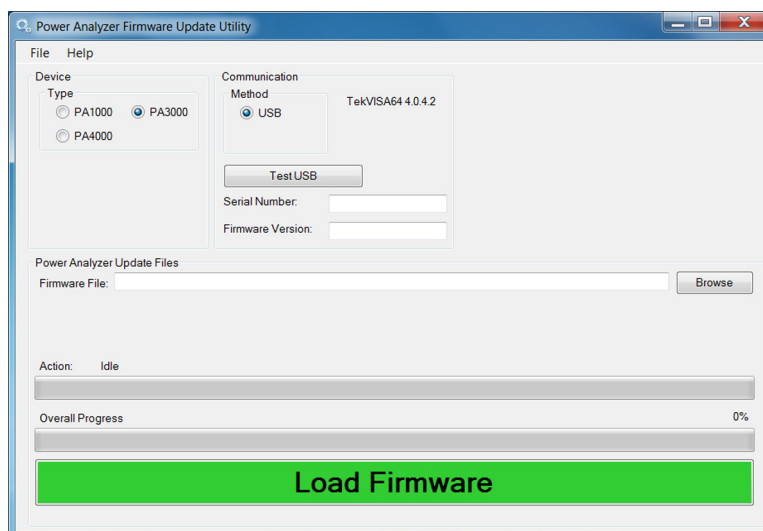

The software supports the downloading of firmware through USB.

1. Select PA3000 as the Device Type.
2. Click the Test USB button to see the serial number and firmware version of the PA3000.
3. Point the software to the firmware file.

The file will be named in the form of “PA3000_va_b_c.bin” where a, b, and c are decimal numbers representing the firmware version number; such as, PA3000_v3_1_0.bin.

The file can also be found on Tektronix Web site under the PA3000 page.

4. When ready, click **Load Firmware**.



CAUTION. *Do not remove power from the PA3000 during the download.*

During the second stage of the download, the PA3000 screen will go blank and the SHIFT key will blink.

After the second stage completes, the PA3000 will restart with the normal screen and additional firmware sections will be downloaded.

At this point wait until the dialog box on the PC appears “Firmware has been loaded successfully.”

Application examples

Most single and three phase power measurements can be made on a PA3000 using the default settings. The power analyzer is fully auto-ranging and because of its proprietary frequency detection technique and peak ranging, it will adjust itself to make the required measurements to the published specification irrespective of frequency or crest factor

Certain measurements can be optimized using the special modes built in to the power analyzer such as Standby Power mode, Integration mode, Ballast mode, or PWM mode. The following application examples demonstrate the use of some of these capabilities.

Each application example discusses two methods of making the same measurements with some variations. The first method refers to making the measurements directly on the PA3000 and the second shows the use of free PWRVIEW software. The PA3000 is great for most bench measurements that need quick checks or monitoring while the PWRVIEW software with default applications and compliance test suites, makes it easy to remotely control, analyze, log, and run compliance tests. For PWRVIEW installation instructions, please go to the product page on www.tek.com.

Tektronix recommends looking over all of the application examples to get the best understanding of all features that the PA3000 and the PWRVIEW software have to offer.

The following application examples are provided in this section:

- Efficiency testing single phase applications (See page 104.)
- Efficiency testing three phase applications (See page 112.)
- Energy consumption testing (See page 121.)
- Standby power measurements (IEC 62301 Ed. 2.0) (See page 127.)
- Inrush current testing (See page 133.)

Example 1: Efficiency testing single phase applications

The push towards green energy in recent years has raised the standards for efficiency across all electronic and electrical products. Stricter energy standards such as *Level VI efficiency protocol*, command tighter limits on efficiency which makes it important to accurately measure input and output power and simultaneously calculate efficiency over different load and source conditions. This example demonstrates a simple method to make efficiency measurements on an external AC-DC power supply that is rated to the level VI efficiency standard. Similar principles can also be applied to efficiency testing on any AC-DC power supplies, DC-AC inverters, and other related converters including solar inverter and UPS systems.

Measurement challenge

Efficiency measurements are straight forward; they accurately measure input power and output power, and calculate efficiency over specified load and source conditions. This example describes the setup and process for making accurate and repeatable efficiency measurements on an external power supply. Make sure the device under test is stable after the initial turn-on. A burn in time of 30 minutes is recommended before taking any efficiency measurements. Many efficiency standards also call for checking stability for about five minutes before taking the final measurement at a given load setting.

Measurement solutions

Efficiency can be measured directly on the PA3000 power analyzer display or through the PWRVIEW software. The direct method is ideal for a quick test and monitoring; however, for long term testing and recording, the PWRVIEW software is recommended. The PWRVIEW software makes it easy to configure, monitor, set custom limits, and record efficiency measurements. These features are especially useful if you are measuring to energy efficiency standards where prolonged logging is required.

Test setup

Complete the following steps to set up the efficiency measurement on an AC-DC power supply with the PA3000 Power Analyzer:

1. Connect the AC input on the device under test (DUT) to the first channel of the PA3000 using a Tektronix Breakout Box (BB1000) as shown in the wiring diagram. (See Figure 38 on page 105.)

The breakout box taps in to the current signal and measures the voltage across the input terminals. It makes it easier and safer to connect the input AC signal on the DUT using the 4 mm safety leads provided with PA3000.

2. Connect the output DC terminals on the second channel of the PA3000 using the provided safety leads. The current shunt on the PA3000 is connected in series with the output load; the voltage channels are connected across the positive and negative terminals of the power supply as show in the figure.

- After making all of the connections, use one of the two methods to make the efficiency measurements.

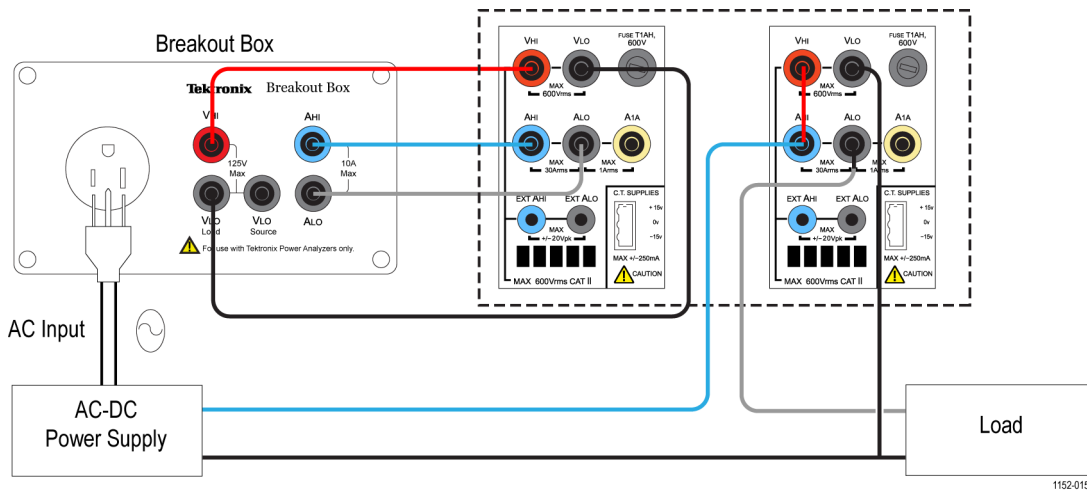

Figure 38: AC-DC efficiency measurement wiring diagram



Method 1: Efficiency measurements on single phase AC-DC power supplies. (PA3000 direct)



The following steps describe the process for setting up the PA3000 for efficiency measurements on an AC-DC power supply. This procedure can also be used for testing efficiency on other applications such as: UPS systems, LED drivers, or DC-AC inverters.

GROUP A Ch1	GROUP B Ch2	GROUP C Ch3	GROUP D Ch4	Result 1332
Vrms 109.85	V Vrms 12.077	V Vrms 109.88	V Vrms 11.965	▲
Arms 330.82	mA Arms 1.3762	A Arms 136.85	mA Arms 527.76	▲
Watt 20.628	W Watt 16.620	W Watt 7.3105	W Watt 6.3129	▲
VA 36.339	VA Vdc 12.077	V VA 15.037	VA Vdc 11.965	▲
Freq 60.000	Hz Adc 1.3762	A Freq 60.000	Hz Adc 527.63	▲
PF 0.5677		PF 0.4862	VII -----	▲
Apk+ 1.0227	A	Apk+ 494.55	mA	▲
Apk- -1.0184	A	Apk- -485.91	mA	▼
Vdc 10.299	mV	Vdc 37.148	mV	▼
EFFICIENCY1	80.569 %	EFFICIENCY2	86.329 %	▼
-----		-----		02:02P 11/20

Figure 39: Efficiency measurement on the PA3000

1. Set the PA3000 to the default configuration:

- a. Press 
- b. Scroll down to **User Configuration** and press .
- c. Select **Load Default Configuration**, and then press  to confirm.

The PA3000 will load the defaults and display a confirmation screen. Press  and then return to the Main Menu by pressing .

2. In the Main Menu, go to **Measurements**, press , and then select the desired parameters for the AC input signal.

The first channel will be represented as Group A on the yellow bar at the top of the screen.

Select the desired measurements such as Vrms, Arms, Watts, VA, PF, Acf, Athd, and A Harmonics.



3. Select Group B representing the second channel on the PA3000 by pressing the right arrow key on the left panel of the PA3000.
4. Select the desired measurements for the DC output such as Watt, Vdc, and Adc; deselect any preset measurements that are not needed.

5. After selecting all of the desired parameters, press  to view the Results screen.







The PA3000 is now set up for making AC and DC measurements on the first and second channels respectively.

6. Power on the DUT from the AC source; an appropriate load can be applied to the DUT at this point.

The Results screen should start updating the real time measurements.

7. The Math function can be used for calculating efficiency. Press  to set up the efficiency formula.
8. On the Math screen, press the MATH soft key.
9. Select the desired function from the list and then press  to enter the options.



NOTE. The Edit Function can be used to edit any specific math formula. While in the edit function, press  to enter the Help menu for help in formatting the function or refer to the information earlier in this manual. (See page 56, Math results.)

10. For the efficiency calculations, enter $(CH2:W/CH1:W)*100$ and then press . Press  to go back to the Math menu where the function can be renamed and units can be added, if desired.
11. Go back to the Math menu and scroll down to the newly edited function and enable the function by pressing . Select all functions that need to be displayed on the screen.
12. Press  to view the Results screen.
13. To view selected math formulas, press .
14. To view math formulas along with other results, press  to view the Results screen and press  multiple times until the math window appears at the bottom of the screen.

You are now ready to take efficiency measurements on an AC-DC power supply.

Further settings if required

Data logging. The logging feature allows you to log data over time for prolonged efficiency testing involving load and source sweeps. Use the DATA OUT key to log data to any compatible flash drive connected to the front panel USB connector. The actual logging interval can be changed by pressing  and going to **Interfaces** → **USB Host Data Out**. The log file will be saved as a .csv file.

Waveforms and harmonics. To monitor AC input waveforms and harmonics, use the  or  key respectively. Switch between channels by using the arrow keys on the left panel. Various options for viewing waveforms and harmonics can be selected from within the Graphs and Waveforms menu.

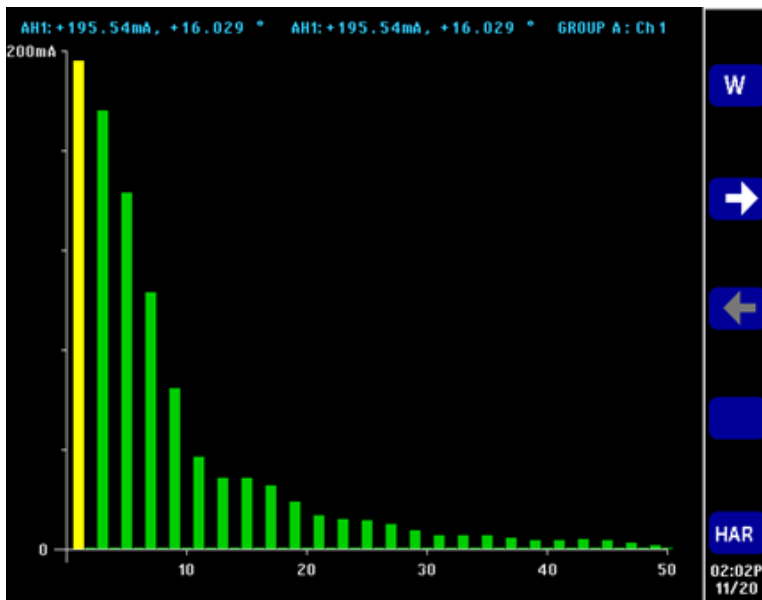

Figure 40: Harmonic bar chart on the PA3000

Method 2: Efficiency measurements on single phase AC-DC power supplies. (PWRVIEW software)

The following steps describe the process for setting up the PWRVIEW software with a PA3000 for efficiency measurements.

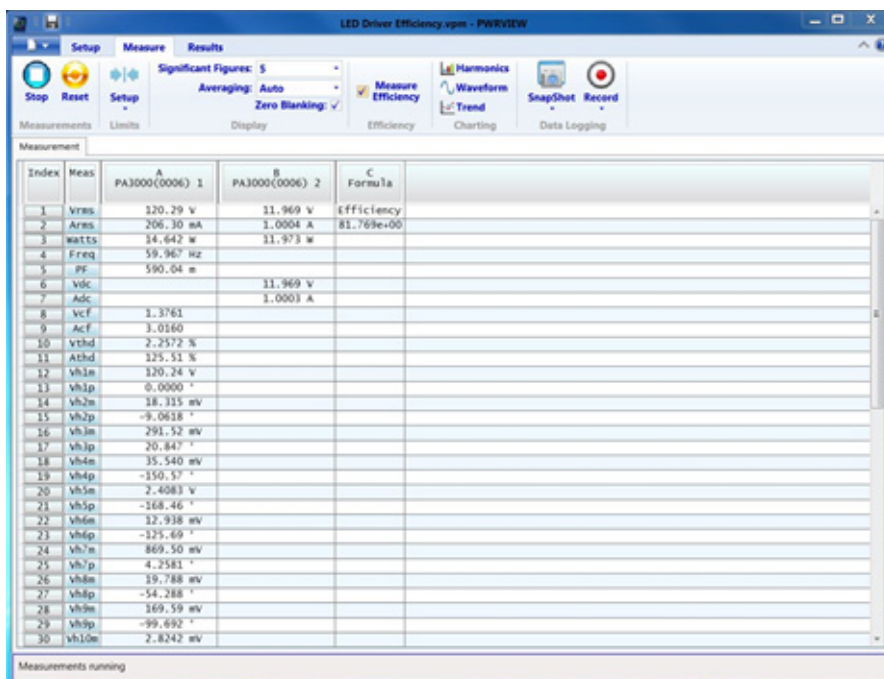

Figure 41: Efficiency measurement with the PWRVIEW software

1. Connect the PA3000 to the computer with the PWRVIEW software installed using the supplied USB cable. Ethernet or GPIB can also be used, if desired.
2. Open the PWRVIEW software by double-clicking the desktop icon.
3. Click the Add button to connect the PA3000.

All available instruments will be listed in the selection panel.

4. Select the desired instrument (the PA3000) and then click Connect.

NOTE. *There are various default applications and compliance tests on the left panel that you can select from. This example discusses the AC-DC LED Driver efficiency measurement. This method can also be used for similar AC-DC power supplies.*

5. Select LED Driver Efficiency under the Applications/Test section on the left panel and then click the Wizard button.

The wizard helps with wiring and shunt selections. A 1 A shunt or 30 A shunt can be selected based on the peak input and output currents.

6. Make changes on the setup wiring as suggested.
7. Click Finish when done and the page will direct you to the Efficiency Setup tab.
8. Verify the instrument and group information and then click the check box for the Measurement Efficiency.

PWRVIEW is now ready to take efficiency measurements.

9. Click the Measure tab page at the top and then click the blue Start button.

The measurements will start updating.

10. To add more measurements or change other settings, such as range and filters, go to the Setup tab and select the desired settings.

NOTE. *The measurements have to be stopped to make any changes on the Setup page. Stop the measurements by clicking the Stop button on the bottom of the Setup page.*

Further settings if required

Waveform, Harmonics, and Trend Chart. In the measurement Grid, you can view Waveform, Harmonics, and Trend charts by clicking the respective icons on the menu bar.

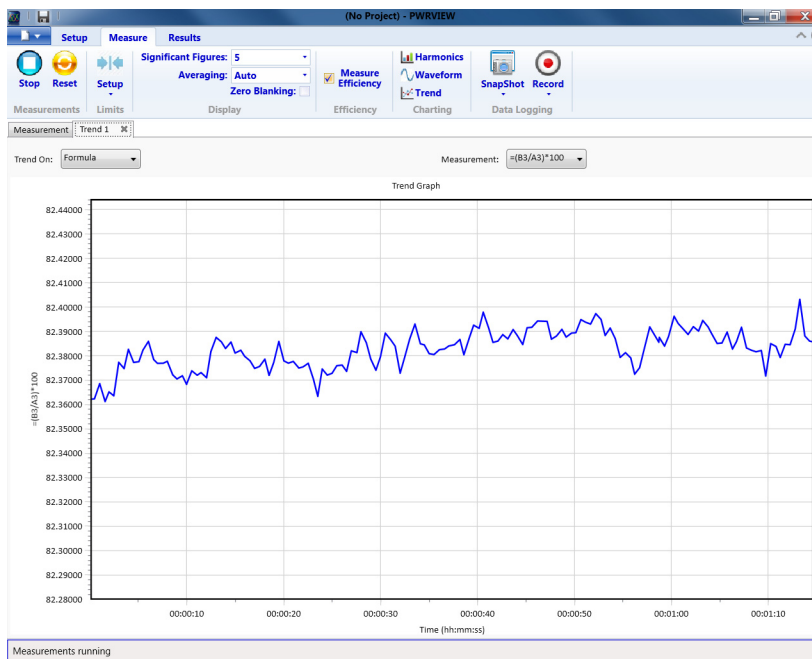

Figure 42: Efficiency Trend Chart

- Waveforms in the PWRVIEW software are constructed using the harmonic data collected from the power analyzer. The accuracy of the waveform depends on the amount of harmonic information available. For optimum results, select maximum number of harmonics to display in the setup area. Selecting 100 harmonics for the PA3000 gives the best results. If no harmonics are selected, waveform feature will display a blank screen.
- The Harmonic bar chart can be enabled for all voltage, current, and watts measurements. Up to 100 harmonics can be selected through the setup screen. Hovering over any harmonic bar will display the absolute value and percentage of fundamental for that harmonic.
- The Trend chart can be activated for any measurement parameter by either right clicking on the desired parameter or by clicking the Trend icon on menu bar. The Trend chart can be reset by using the Reset button on the menu bar.

Data logging. Recording data is important for most efficiency measurements where load and source sweep is required.

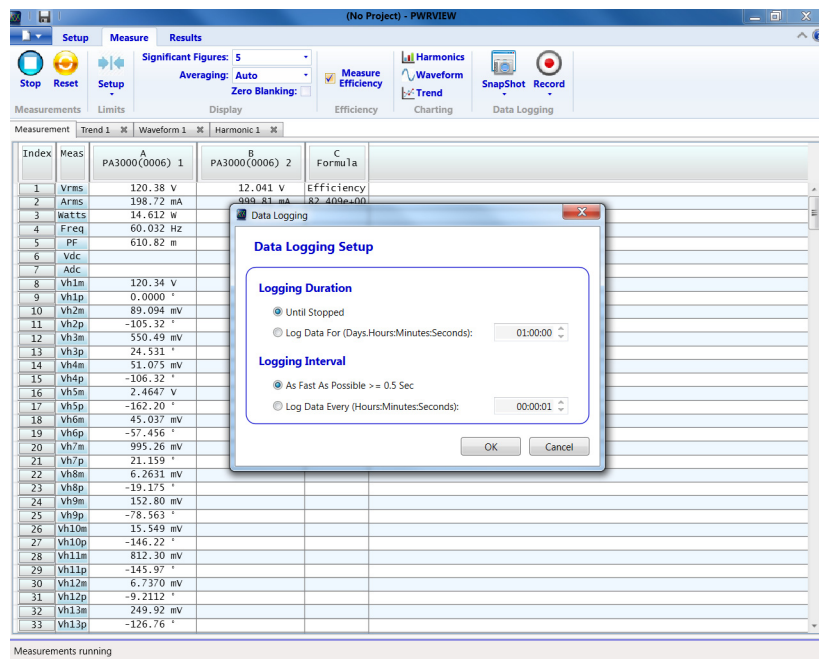

Figure 43: Logging setup

- To record data using PWRVIEW, click the Record button on the menu bar. The software will start recording all the selected data including formulas and limits.
- To change the data logging rate or to set the total log time, click the down arrow on the Record icon to open the data logging setup. Here you can select the desired logging duration and interval.
- To stop the data logging, click the Stop button.
- All the recorded data is stored in a database on the local computer. To access the data, click the Results tab and then click the Measure icon. The dialog box will present all the archived data.
- Select the desired data set and export to either an Excel or a .csv format.

Custom limits. Custom limits can also be set with any of the measurement parameters. Custom limits help set limits based on various standards or test specifications.

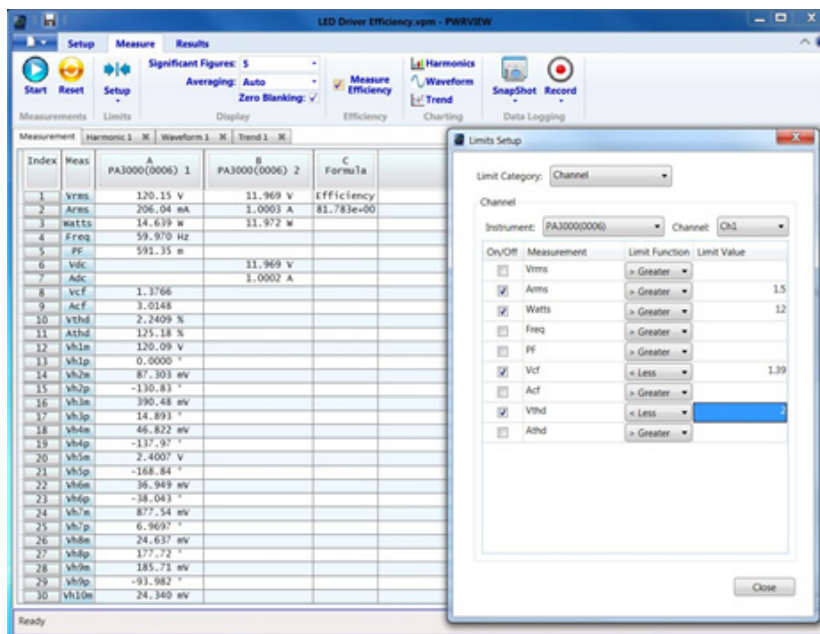

Figure 44: Custom limits setup

- To set custom limits, either right-click the desired measurement parameter or click the Limits Setup icon on the menu bar. Stop the measurement update to set up custom limits.
- Custom limits will appear as a separate tab on the measurement grid. The result column will display red fonts if the limits are failing. Hovering over the results will display the limit function, limit value, and relative value.

Example 2: Efficiency testing three phase applications

Applications such as motor drives, wind power turbines, and other large loads rely on three phase power delivery to make the system more efficient and economical. This example discusses how the PA3000 can help with three phase efficiency measurements. The example applies to various three phase AC-DC, DC-AC Inverters, and AC-AC converter applications such as PWM motor drive, three phase inverters, three phase UPS systems, and wind power.

Measurement challenge

Measurements on a three phase application can be complex due to floating high power signals and complex power calculations that can be prone to errors. Ideally the three phases should be symmetric with balanced phases, but in most real world applications there is always some imbalance due to inconsistencies in the load impedance, cabling, and other system aspects. It is important to have highly accurate isolated measurements with good phase accuracy and synchronization between the measurement channels.

Measurement solutions

There are two main wiring configuration that can be used while measuring three phase power. The two wattmeter method is common with 3-phase, 3-wire applications and three wattmeter method is common with 3-phase, 4-wire applications. Refer to the wiring section for details on all available wiring configurations. (See page 47, *Wiring*.)

The two wattmeter method can be used for measuring efficiency on three phase in and three phase out applications using four power measuring channels. The three wattmeter method is preferred for applications that have a dedicated neutral cable. The following methods discuss different configurations for three phase power measurement and demonstrates efficiency measurements on a three phase system.

Method 1: Efficiency measurements on three phase PWM motor drive (PA3000 direct)

This method demonstrates three phase power and efficiency measurements on a single phase input and three phase output PWM motor drive directly on the PA3000 display.

Test Setup

The following steps describe the process to set up the efficiency measurement on a single phase input PWM motor drive using the PA3000.

1. Connect the single phase AC input on the PWM motor drive to the first channel of the PA3000 using a Tektronix Breakout Box (BB1000) as shown in wiring diagram.

The breakout box taps into the current signal and measures the voltage across the input terminals. It makes it easier and safer to connect input AC signal on the DUT with the 4 mm safety leads provided with the PA3000.

2. Connect the three phase output of the PWM drive to other three channels using the 3 phase 4 Wire configuration as shown in the wiring diagram.

All three phases are set up in series with the internal shunt and the voltage is measured across respective phase and neutral.

3. If the motor drive does not have a dedicated neutral cable, create a floating neutral by connecting all three VLO terminals on channels 2, 3, and 4 together.

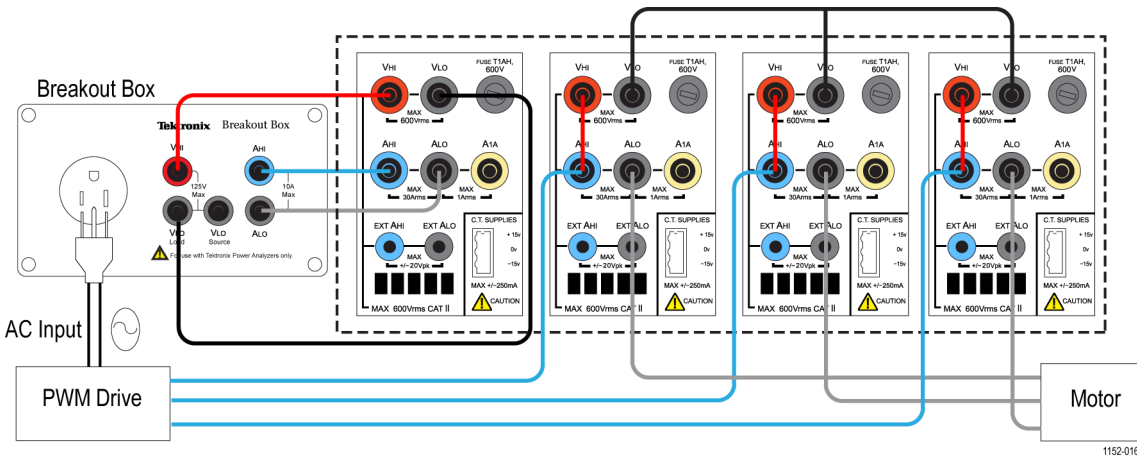







Figure 45: PWM motor drive efficiency (1 phase in and 3 phase out)

4. After making all of the connections, set the PA3000 to the default configuration:

- a. Press 
- b. Scroll down to **User Configuration** and press .
- c. Select **Load Default Configuration**, and then press  to confirm.

The PA3000 will load the defaults and display a confirmation screen. Press  and then return to the Main Menu by pressing .



5. To select the correct wiring configuration within the Main Menu, go to **Inputs** → **Wiring** → **Configuration** and select **1 Phase 2 Wire** for Group A.
6. Scroll to Group B by pressing the arrow key on the left front panel and select **3 Phase 4 Wire**.

NOTE. *If desired, both groups can be named for ease of monitoring. Go back one step and enter the appropriate name using the Group Name option.*







7. The PA3000 makes it easy to configure important settings using default modes. For the PWM motor drive output, from the Main Menu by select **Modes** → **Select Mode** → **PWM Motor**.

The PWM Mode will set up the PA3000 to accurately measure the output voltage of a typical PWM drive that switches at high frequencies. The algorithm applies a proprietary sensing method to determine the actual fundamental power frequency in real time for all power calculations so that the calculated power and harmonic data are always accurate even in dynamic speed conditions.

The PWM Mode is not required for the input line frequency measurements. The PWM Mode and other modes are described under the Modes section. (See page 42, *Modes*.)

8. To enable sum measurements for the three phase output on group B, enable the Sum Results column by entering the Main Menu and going to **Measurement Configuration** → **Sum Results Column** → **Enabled**.
9. To make the efficiency measurements, enable the Math function by pressing  and then pressing the MATH soft key.
10. Select the desired function to edit and press  to enter the options.

NOTE. *The Edit Function can be used to edit any specific math formula. While in the edit function, press  to enter the Help menu for help in formatting the function or refer to the information earlier in this manual. (See page 56, *Math results*.)*

11. For the efficiency calculation, enter (GRP B:SUM:W/CH1:W)*100 and then press . Press  to go back to the Math menu where the function can be renamed and units can be added, if desired.
12. Go back to the Math menu and scroll down to the newly edited function and select the function by pressing . Select all functions that need to be displayed on the screen.
13. Press  to view the Results screen.
14. To view selected math formulas, press .
15. To view math formulas along with other results, go back to the Results screen and press  multiple times until the math window appears at the bottom of the screen.

You are now ready to take efficiency measurements on a PWM Motor drive with single phase input and three phase output.

Further settings if required

Torque and speed inputs. The overall efficiency of a motor drive system requires measuring real-time speed and torque data. PA3000 has four analog and two counter inputs to enable various auxiliary input measurements such as torque and speed. More information on specifications of this inputs can be found under Auxiliary inputs and output section of this manual. (See page 149, *Auxiliary inputs/outputs*.)

- Refer to the pin number for desired analog or counter input under *Auxiliary inputs/outputs* and connect the signal (torque, speed, or others) directly to the respective pin on the AUXILIARY INPUTS/OUTPUTS connector on the rear panel.
- The auxiliary inputs can be enabled and viewed through the math screen.

Press  and then press the MATH soft key to enter options. Select any desired function and edit function as ANA1, ANA2, ANA3, or ANA4 for analog inputs and COUNT1 or COUNT2 for counter inputs to enable and view auxiliary inputs on the screen.

- To view the math screen along with other results, press  multiple times until the math window appears on the bottom of the display.

Data logging. The logging feature allows you to log data over time for prolonged efficiency testing involving load and source sweeps. Use the DATA OUT key to log data to any compatible flash drive connected to the front panel USB connector. The actual logging interval can be changed by pressing  and going to **Interfaces** → **USB Host Data Out**. The log file will be saved as a .csv file.

Waveforms, harmonics, and vector graphs. Waveforms, harmonics, and vector graphs can be enabled for all three phase signals.

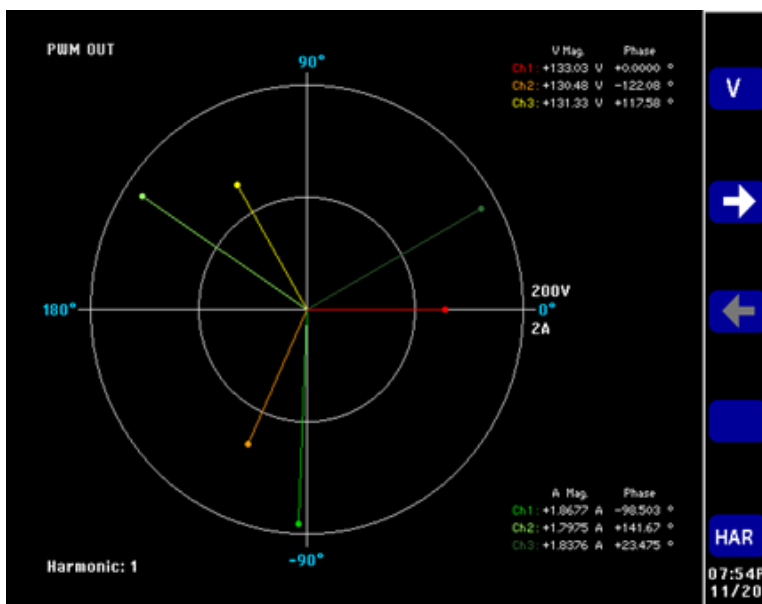





Figure 46: Vector graph on the PA3000

- To monitor AC waveforms, harmonics, or the vector graph use the , , or  keys respectively.
- Switch between channels using the arrow keys on the front panel.
- Select various options for viewing waveforms and harmonics within the Vector and Waveforms menus.

Method 2: Efficiency measurements on three phase PWM motor drive (PWRVIEW software)

This method discusses efficiency measurement on three phase input and output PWM motor drives using the PWRVIEW software.

Test setup

1. Connect the three phase AC input of the PWM motor drive to the first two channels of the PA3000 as shown in wiring diagram. (See Figure 47.)
2. Connect the three phase output of the PWM drive to the other two channels using the configuration as shown in the wiring diagram.

NOTE. The 3 phase 3 wire (2 Wattmeter) configuration enables testing three phase signals by using two power channels. This method can be used for simultaneously testing 3 phase input and outputs on a 4 channel power analyzer. Detailed information on the wiring configurations is given in the wiring section of this user manual. (See page 47, Wiring.)

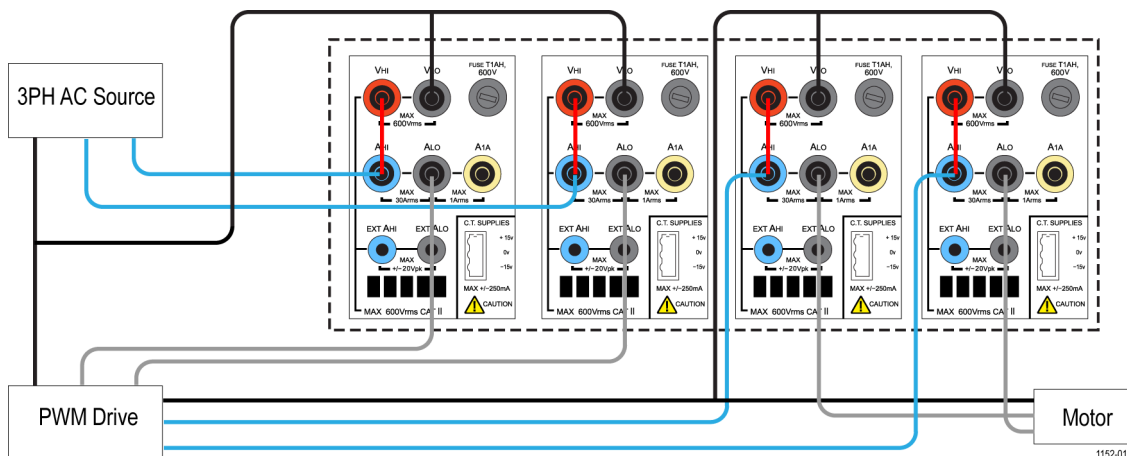

Figure 47: PWM Motor drive efficiency (3 phase in and 3 phase out)

3. After making all of the power connections, connect the PA3000 to the computer with the PWRVIEW software installed using the supplied USB cable. Ethernet or GPIB can also be used, if desired

4. Open the PWRVIEW software by double-clicking the desktop icon.
5. Click the Add button to connect the PA3000.

All available instruments will be listed in the selection panel. Select the desired instrument (the PA3000) and then click Connect.

NOTE. *There are various default applications and compliance tests on the left panel that you can select from.*

6. Select PWM Motor Drive Efficiency under the Applications/Test section on the left panel and then click the Wizard button.

The wizard helps with wiring and shunt selections.

7. Select the three phase input and three phase output on the wizard and enter the expected current in the appropriate box.
8. Click Finish when done and the page will direct you to the Efficiency Setup tab.
9. Verify that the instrument and group information and then click the check box for the Measurement Efficiency.

PWRVIEW is now ready to take efficiency measurements.

10. Go to the Measure tab and then click the blue Start button.

The measurements will start updating.

11. To add more measurements or change other settings, such as range and filters, go to the Setup tab and select the desired settings.

NOTE. *The measurements have to be stopped to make any changes on the Setup page. Stop the measurements by clicking the Stop button on the bottom of the Setup page.*

Further settings if required

Torque and speed inputs. The overall efficiency of a motor drive system requires measuring real-time speed and torque data. The PA3000 has four analog and two counter inputs to enable various auxiliary input measurements such as torque and speed. More information on specifications of this inputs can be found under Auxiliary inputs and output section of this manual. (See page 149, *Auxiliary inputs/outputs.*)

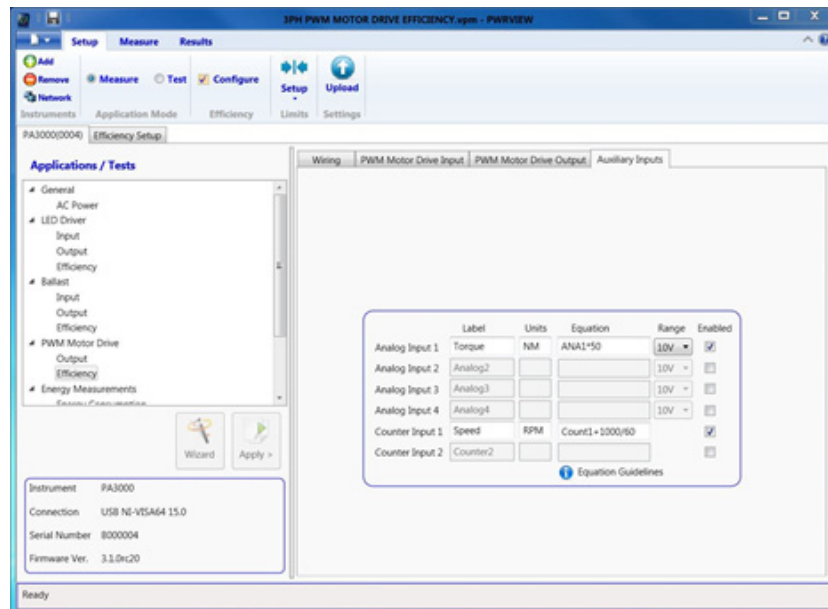

Figure 48: Auxiliary inputs setup for torque and speed measurements

- Refer to the pin number for desired analog or counter input under *Auxiliary inputs/outputs* and connect the signal (torque, speed, or others) directly to the respective pin on the AUXILIARY INPUTS/OUTPUTS connector on the rear panel.
- To enable the auxiliary inputs using PWRVIEW, go to the Setup tab.
- On the Setup tab, go to the Wiring page and select the check box near the bottom of the page for enabling the *Auxiliary Inputs (Analog and Counters)*. A new tab page named Auxiliary Inputs will be created.
- On the Auxiliary Inputs tab page, enter the desired label, units and equation for the respective analog and counter inputs. Equation Guidelines on the bottom can be used for assistance with entering equations. Enable the desired inputs.
- Go to the Measure tab page and click the Start button.

The selected analog and counter input signals will be displayed on the measurement grid with proper labels and units.

- Desired formulas for further equating system efficiency using analog and counter inputs along with any other measurement parameters can be entered in the Formula column on the measurement grid.

Waveform, Harmonics, and Trend chart. In the measurement grid, you can view waveforms, harmonics, and trend charts by clicking the respective icons on the menu bar.

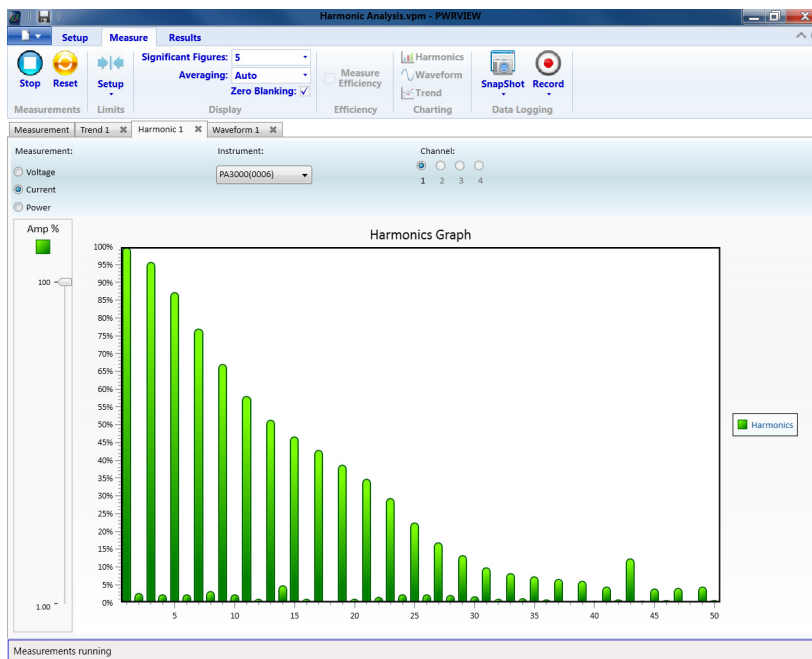

Figure 49: Harmonic bar chart

- Waveforms in the PWRVIEW software are constructed using the harmonic data collected from the PA3000. The accuracy of the waveform depends on the harmonic information available. For optimum results, select the maximum number of harmonics to display in the setup area. Selecting 100 harmonics for the PA3000 gives the best results. If no harmonics are selected, waveform feature will display a blank screen.
- The Harmonic bar chart can be enabled for all voltage, current, and watts measurements. Up to 100 harmonics can be selected through the setup screen. Hovering over any harmonic bar will display the absolute value and percentage of fundamental for that harmonic.
- The Trend chart can be activated for any measurement parameter by either right-clicking the desired parameter or by clicking the Trend icon on the menu bar. The Trend chart can be reset by clicking the Reset button on the menu bar.

Data logging. Recording data is important for most efficiency measurements where load and source sweep is required.

- To record data using PWRVIEW, click the Record button on the menu bar. The software will start recording all the selected data including formulas and limits.
- To change the data logging rate or to set the total log time, click the down arrow on the Record icon to open the data logging setup. Here you can select the desired logging duration and interval.
- To stop the data logging, click the Stop button.

- All the recorded data is stored in a database on the local computer. To access the data, click the Results tab and then click the Measure icon. The dialog box will present all the archived data.
- Select the desired data set and export to either an Excel or a .csv format.

Custom limits. Custom limits can also be set with any of the measurement parameters. Custom limits help set limits based on various standards or test specifications.

- To set custom limits, either right-click the desired measurement parameter or click the Limits Setup icon on the menu bar. Stop the measurement update to set up custom limits.
- Custom limits will appear as a separate tab on the measurement grid. The result column will display red fonts if the limits are failing. Hovering over the results will display the limit function, limit value, and relative value.

Example 3: Energy consumption testing

Energy consumption testing on home and office appliances is required for compliance to many international and regional standards programs such as ENERGY STAR®. Energy consumption testing involves the integration of power consumed over a long period of time, often days. Use the dedicated Integration Mode on the PA3000 to make energy consumption testing easier and faster.

Measurement challenges

Energy consumption testing is often done over a wide range of loads and requires an accurate measurement system that can capture all dynamic load changes. If the load is expected to have several load variations, Tektronix recommends to set up the PA3000 in manual range.

Measurement solutions

The Integrator mode on the PA3000 integrates desired measurements over a specified period. Integrator mode enables measurement options such as Watt-Hours, VA-Hours, Amp-Hours, and Hours under the Measurements menu. Integration measurements are on a per-group basis and can be enabled for single and three phase configurations. Detailed information on integration setup and all available measurements is covered under the Integrator mode section in this manual. (See page 43, *Integrator mode*.)

Test Setup

The following steps describe the process to set up energy consumption measurements on a home or office appliance using a PA3000. This method can be used for testing energy consumption of any DUT that plugs into the AC wall socket for power.

1. Connect the AC input on the DUT to the first channel of the PA3000 using a Tektronix Breakout Box (BB1000) as shown in the wiring diagram.

The breakout box taps in to the current signal and measures the voltage across the input terminals. It makes it easier and safer to connect the input AC signal on the DUT using the 4 mm safety leads provided with the PA3000.

2. After making all of the connections, use one of the two methods to make the efficiency measurements.

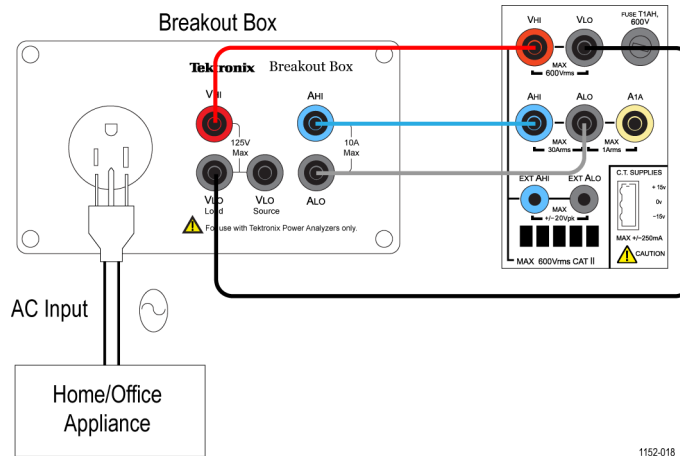

Figure 50: Energy consumption measurements wiring diagram

**Method 1: Energy
consumption
measurements (PA3000
direct)**

The following steps describe the process to set up energy consumption testing on home or office appliances using the PA3000.

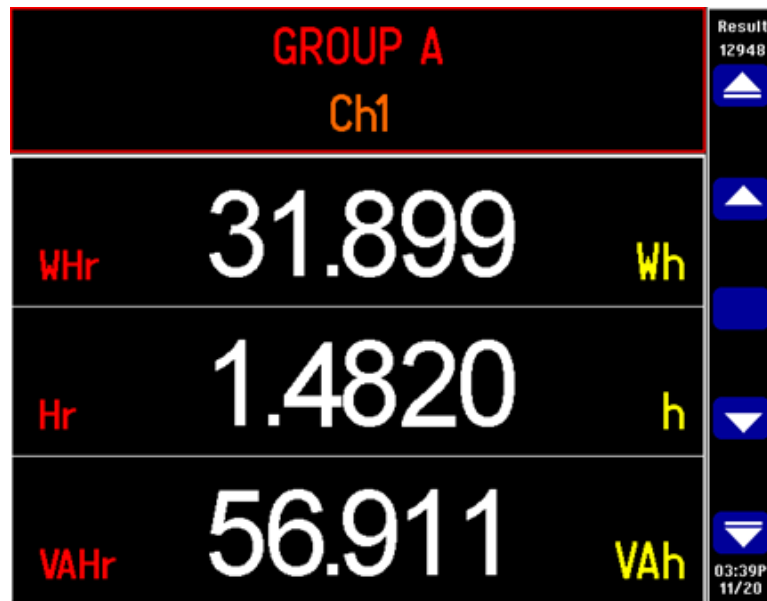









Figure 51: Energy consumption testing on the PA3000

1. Set the PA3000 to the default configuration:
 - a. Press .
 - b. Scroll down to **User Configuration** and press .
 - c. Select **Load Default Configuration**, and then press  to confirm.

The PA3000 will load the defaults and display a confirmation screen. Press  and then return to the Main Menu by pressing .
2. To enable the Integrator mode, go to **Modes** → **Select Mode** → **Integrator**.
3. Press , select **Setup Modes** → **Integrator Setup**, and select the desired start method.
 - Manual works by pressing the INTEG RUN key to start and stop integration.
 - Clock allows for setting up a specific time to start integration.
 - Level allows you to set trigger levels on a specific signal to start the integration measurement.

- Go back to the Integrator Setup menu to configure the clock start, duration or the trigger level.

NOTE. *The Integrator Setup menu also provides an option to set up the target power factor for the design. This feature displays the value of VARs required to correct the average power factor to the target power factor. Refer to the Integrator mode section of this manual for more information on each option. (See page 43, Integrator mode.)*

- After you have set the integration mode and selected the start-stop method, press .

The PA3000 will display integration parameters such as: Hr, Whr, VAHr, and AHr.

- Power on the DUT and the results on the PA3000 should start updating.

The integration results will display zero until it is triggered either manually using the INTEG RUN key on the front panel or by the selected start method.

The LED under the INTEG RUN key stays on while integration measurements are running.

- To stop the integration, press the INTEG RUN key again; to reset, use the RESET/CLEAR key.

The integrator can be run simultaneously on all groups/channels on the PA3000.

While in the integrator mode, the integration graph can be enabled by pressing . The graph displays all integration measurements for a given group. Scroll through the different groups by using the arrow keys on the front panel.

Other parameters to graph can be selected by pressing the INT soft key.

Further settings if required

Data logging. The logging feature allows you to log data over time for prolonged efficiency testing involving load and source sweeps. Use the DATA OUT key to log data to any compatible flash drive connected to the front panel USB connector. The actual logging interval can be changed by pressing  and going to **Interfaces** → **USB Host Data Out**. The log file will be saved as a .csv file.

Ranging. By default the PA3000 is auto-ranging. Auto-ranging is fast and generally unnoticeable, but might lead to loss of data while the auto-ranging occurs. Using a fixed range while measuring energy consumption ensures that no data is lost during the ranging process. To set a fixed range, press  and go to **Ranging** → **Current Range**, and then choose a suitable fixed range, based on the measurements made during auto-ranging. If the range is too low, a warning

message will display. This will not harm the PA3000. The range should not be set too high as this will compromise the overall accuracy.

Method 2: Energy consumption testing (PWRVIEW software)

The following steps describe the process to set up energy consumption tests on home or office appliances using a PA3000 along with the PWRVIEW software.

1. Use the same test setup as with the preceding PA3000 direct example.
2. After making all of the power connections, connect the PA3000 to the computer with the PWRVIEW software installed using the supplied USB cable. Ethernet or GPIB can also be used, if desired
3. Open the PWRVIEW software by double-clicking the desktop icon.
4. Click the Add button to connect the PA3000.
All available instruments will be listed in the selection panel.
5. Select the desired instrument (the PA3000) and then click Connect.

NOTE. *There are various default applications and compliance tests on the left panel that you can select from.*

6. Select Energy Consumption under the Applications/Test section on the left panel and then click the Wizard button.
The wizard helps with wiring and shunt selections.
7. The PA3000 can compute the value of VARs required to correct the power factor to a target value. This can be selected with the wizard by entering the desired power factor.
8. Click Next to review and then click Finish.
9. Go to the Measure tab and then click the Start button to start the measurements.
All integration measurements will be initialized as zero values.
10. Click the green Start button on the top ribbon to start the integration.
Each of the integration measurements should start updating in real time.
11. Reset the integration, if needed, by clicking the green Reset button.

Each individual channel can be used to run integration testing on more than one device. Integration testing can also be used for three phase devices. Select Integration from the Mode drop-down menu on the Setup page for desired channels or for the three phase group.

Further settings if required

Trend chart. The integration graph can be activated through the Trend chart feature in PWRVIEW.



Figure 52: Integration Trend chart

The Trend chart can be activated for any integration measurement by either right-clicking the desired parameter or by clicking the Trend icon on the menu bar. The Trend chart can be reset by using the Reset button on the menu bar.

Data logging. Recording data is important for most energy consumption testing.

- To record data using PWRVIEW, click the Record button on the menu bar. The software will start recording all the selected data including formulas and limits.
- To change the data logging rate or to set the total log time, click the down arrow on the Record icon to open the data logging setup. Here you can select the desired logging duration and interval.
- To stop the data logging, click the Stop button.
- All the recorded data is stored in a database on the local computer. To access the data, click the Results tab and then click the Measure icon. The dialog box will present all the archived data.
- Select the desired data set and export to either an Excel or a .csv format.

Custom limits. Custom limits can also be set with any of the measurement parameters. Custom limits help set limits based on various standards or test specifications.

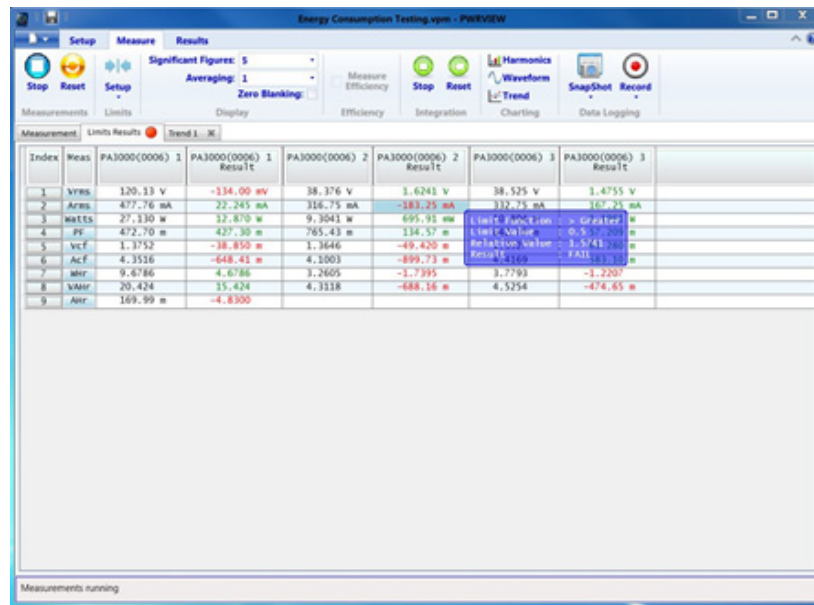

Figure 53: Custom Limits

- To set custom limits, either right-click the desired measurement parameter or click the Limits Setup icon on the menu bar. Stop the measurement update to set up custom limits.
- Custom limits will appear as a separate tab on the measurement grid. The result column will display red fonts if the limits are failing. Hovering over the results will display the limit function, limit value, and relative value.

Example 4: Standby power measurements (IEC 62301 Ed. 2.0)

Power supplies, adapters and common electrical and electronic goods often operate in standby mode. Examples are a TV switched off by a remote control but consuming power while waiting for further remote control, a microwave oven displaying its clock, or a cell phone charger that has finished charging.

The cumulative power drawn by these and other common loads is significant and programs such as ENERGY STAR® and the European Eco-Directives seek to limit the power drawn by equipment when in standby mode. The typical standby power levels continue to decrease from the 1 Watt initiative of 2010 towards the level VI efficiency standards of 2016.

Measurement challenges

The standby power and the measured current are low compared to the normal operating point of the DUT. The PA3000 should accurately measure currents as low as 100 μ A, along with the full-load current. The PA3000 offers low current measurement ranges and very low noise to accurately measure the standby current and power.

To meet the standby regulations, the power supply often operates in burst mode, where, the power is drawn in small bursts and then the circuit is forced to sleep. To make accurate standby measurements in burst mode, the PA3000 executes following:

- Samples the waveforms continuously such that no data is missed.
- Averages all the measured data to produce a stable result.

Measurement solutions

The PA3000 offers a dedicated Standby Power mode for quickly checking standby power on the bench. The PWRVIEW software with the PA3000 also offers full compliance standby power testing to IEC62301 Ed. 2.0. Standard. The 1 A shunt on the PA3000 offers high resolution and accuracy for testing currents as low as 80 μ A. This enables the PA3000 to measure standby power as low as 20 mW at 240 V.

Test Setup

Complete the following steps to set up the PA3000 to make the standby power measurements:

- Connect the DUT using a Tekronix Breakout Box (BB1000) as shown in the wiring diagram. (See Figure 54.)
- Use the 1 A shunt on the PA3000 for better accuracy if the expected current is below 1 A.
- Use the VLO Source connection for voltage. Using the VLO Source terminal for standby power measurements, moves the voltage low node to the source side of the current shunt. This helps eliminate measurement errors due to current drawn by voltmeter impedance of PA3000. This is important while making very low standby power measurements. For all other measurements, VLO Load terminal should be used.

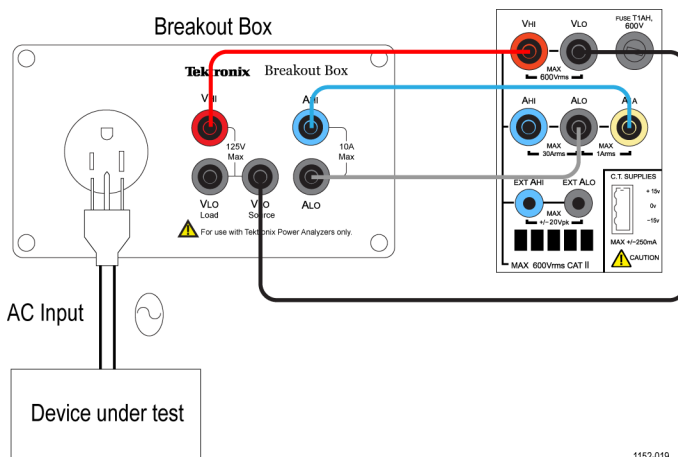

Figure 54: Standby power measurements wiring diagram

Method 1: Standby power quick check (PA3000 direct)

The front-panel mode of the PA3000 is designed to give product designers a fast, yet reliable, check of standby power consumption.

Enabling standby power mode automatically sets a long averaging time to average the typical power variations and bursts and it disables low-level blanking so that very low power and current values can be displayed.

NOTE. The PA3000 samples continuously in standby mode to ensure that no data is lost.

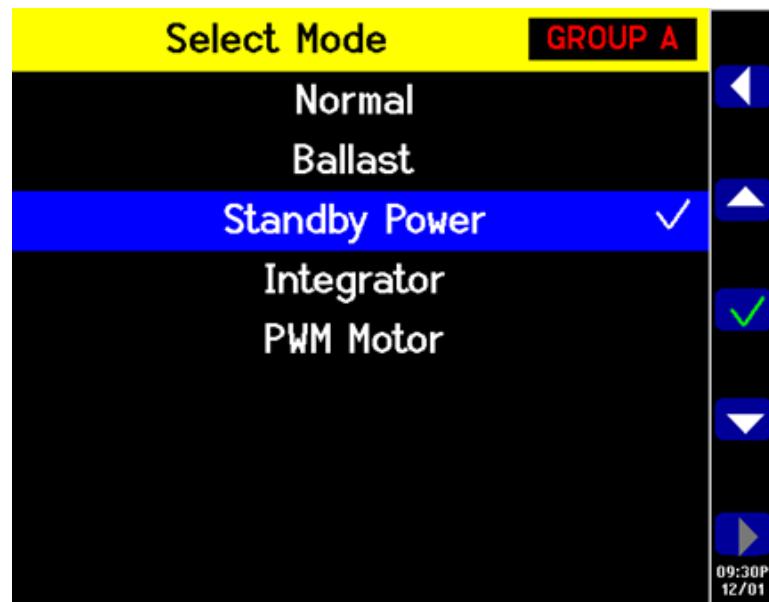





Figure 55: Standby Power mode

If the expected standby current is lower than 1 A, select the 1 A shunt input of the PA3000.

1. To select the 1 A shunt, go to the Main Menu (press ) , go to **Inputs** → **Shunt** and select **Internal 1 A**; press  to confirm.
2. To enable the dedicated Standby Power mode go to the Main Menu, go to **Modes** → **Select Mode** → **Standby Power**, and then press  to confirm.
3. Press  to start making the standby measurements.

Further settings if required

Integration time window. The default integration time is 10 seconds. This can be adjusted as required in the **Modes** → **Setup Modes** → **Standby Setup**. If the DUT is stable, select a shorter time for faster measurements. If the measurements are unstable, choose a longer integration time. If in doubt, use the full-compliance method built-in to the PWRVIEW software.

Ranging. By default the PA3000 is auto-ranging. Auto-ranging is fast and generally unnoticeable, but might lead to loss of data while auto-ranging occurs. Using a fixed range while measuring standby power ensures that no data is lost during the ranging process. To set a fixed range, choose **Inputs** → **Ranging** → **Current Range** and then choose a suitable fixed range, based on the measurements made during auto-ranging. If the range is too low, a warning message will display. This will not harm the PA3000. The range should not be set too high, as this will compromise the overall accuracy.

Bandwidth. For low power standby signals that have undesired high frequency components, low bandwidth filters can be enabled. A low bandwidth 10 kHz filter is available through the Inputs setup. Applying low pass filters might vary the RMS values of voltage, currents, and power as high frequency components affect the RMS values.

Autozero. Use the **Autozero** → **Run Now** function under the System Configuration menu to run autozero before running a standby power test. This will make sure that all the offsets are compensated and the low current and power readings are accurate.

All settings can be saved for later use in the User Configuration menu.

Method 2: IEC 62301 Ed. 2.0 Full compliance standby power testing (PWRVIEW software)

The PWRVIEW software along with PA3000 can test the standby power using full compliance techniques of IEC 62301 Ed. 2.0 / EN50564. Measurements are made easy by using the PWRVIEW software and for making accurate measurements for full compliance standby testing. The software calculates real time instability and executes power averaging as required by the standard.



Figure 56: Full compliance IEC 62301 Standby power test

1. Use the same test setup as with the preceding PA3000 direct example.
2. After making all of the power connections, connect the PA3000 to the computer with the PWRVIEW software installed using the supplied USB cable. Ethernet or GPIB can also be used, if desired.
3. Open the PWRVIEW software by double-clicking the desktop icon.
4. Click the Add button to connect the PA3000.
All available instruments will be listed in the selection panel.
5. Select the desired instrument (the PA3000) and then click Connect.

NOTE. *There are various default applications and compliance tests on the left panel that you can select from.*

6. Click the Test button in the Application Mode area in the Menu bar.
This enables the grayed out Compliance tests on the left panel.
7. Select the IEC 62301 Standby Power option under the Compliance tests and then click the Wizard button.
The wizard provides easy steps to setup up the standby power test.
8. Enter the appropriate information on the respective pages of the wizard and then click through all of the steps to correctly set up the PA3000 for the test.
9. If the input current is less than 1 A, use the 1 A shunt on the PA3000 for better resolution and accuracy.

10. After applying all of the settings, click the Test tab on the top of the PWRVIEW window.

Test details such as laboratory, customer, product information, and environmental conditions can be filled in on the top ribbon before starting the test.

The left panel allows you to select the required power limit, expected frequency, and input voltage.

The default time for running the standby power test according to IEC 62301 is 15 minutes; this can be changed based on regional or local requirements.

11. After completing all of the settings, click the Start button.

The test will run for the time duration selected and will update all the required measurements in the left panel. The standby power variation over time is displayed graphically.

Voltage quality, power stability, and uncertainty is also evaluated in real time as required by the standard.

The test will display the Pass/Fail status based on all evaluated parameters.

The test summary can be reviewed under the Results tab. All of the required parameters will be summarized with a Pass/Fail status under Test Summary and General Results.

The Power Readings tab allows you to scroll through the time scale and to debug specific issues on a given time stamp. Use the scroll bar on the top of the window to scroll through the time line.

The test results can be exported as a full report by clicking the Full Report PDF icon on the top ribbon. Alternately, the raw data can be exported using the Export CSV icon.

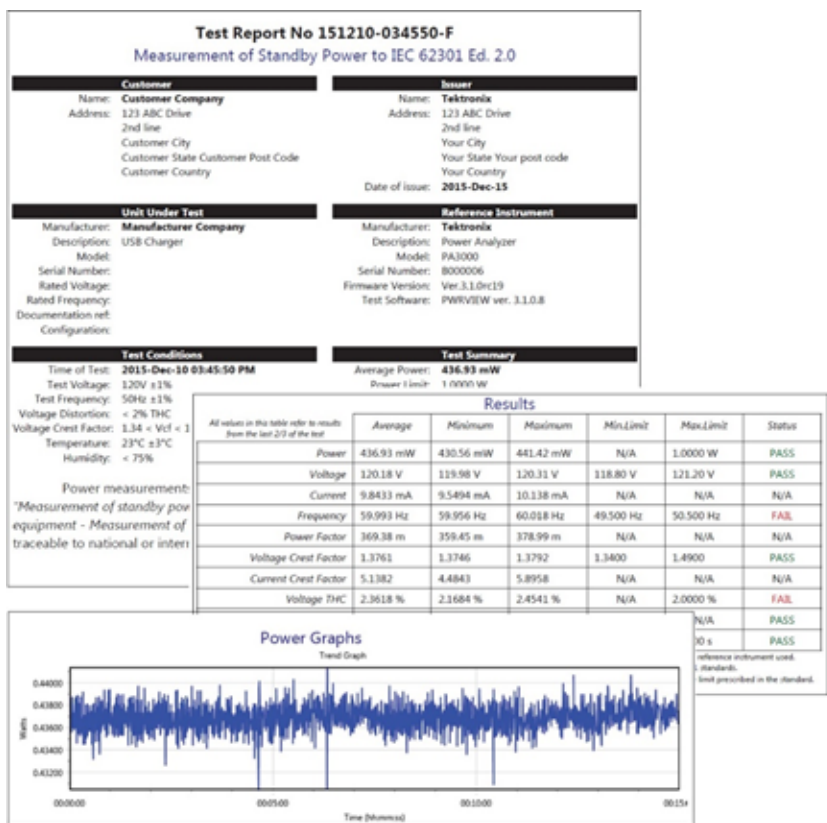

Figure 57: IEC 62301 Ed. 2.0 Standby power test report

Further settings if required

Ranging. By default, the PWRVIEW software sets up the PA3000 current range in Auto-Up-Only. The Auto-Up-Only option ranges up the PA3000 until it finds the highest range where the input signal is not clipped. This helps with setting the best range for the test. Alternatively, if the expected peak currents are known, a manual range can be selected for higher accuracy. The manual range can be selected for the selected shunt through the Setup page under Range options.

Bandwidth. For low power standby signals that have undesired high frequency components, low bandwidth filters can be enabled. A low bandwidth 10 kHz filter is available through the Setup screen under the Filter drop down option. Applying low pass filters might vary the RMS values of voltage, currents, and power as high frequency components affect the RMS values.

AC source. The IEC 62301 Standby Power full compliance test requires the AC source to be very stable as detailed in the standard. The voltage and frequency are required to be within 1% tolerance. In addition, the input VTHC (Voltage Total Harmonic Content) has to be within 2% for the first 13 harmonics and the VCF (Voltage Crest Factor) has to be within the 1.34 to 1.49 range. Tektronix recommends using a stable external AC source that meets standard requirements for the full compliance testing.

Example 5: Inrush current testing

Most electrical devices draw initial current that is significantly higher than the nominal steady state current due to low input impedance. Motor drives and transformers are known to have inrush current twenty times higher than the steady state currents. It is important to characterize inrush current to determine input conductor and fuse ratings.

Measurement challenges

Accurate measurement of inrush current requires high sampling rate and no-gap signal acquisition. It is important that the correct current range is selected on the measuring equipment while measuring the inrush current as the current can be significantly higher than the expected steady state current.

Measurement solutions

The PA3000 with 1 MS/s sampling rate can accurately record peak signal samples for inrush current measurements. The Min and Max hold function through the PA3000 menu allows you to capture inrush current and other peak events on the front screen. Inrush current measurements can also be made through the PWRVIEW software. This example discusses the PA3000 setup to measure inrush currents.

Test Setup

Complete the following steps to set up the PA3000 to take the inrush current measurements:

- Connect the DUT using a Tektronix Breakout Box (BB1000) as shown in the wiring diagram. (See Figure 58.)
- Use the 30 A shunt on the PA3000 for inrush current measurements. Using the 1 A shunt is not recommended for inrush current because peak currents can be quite high, even for applications where the nominal steady state current is below 1 A.

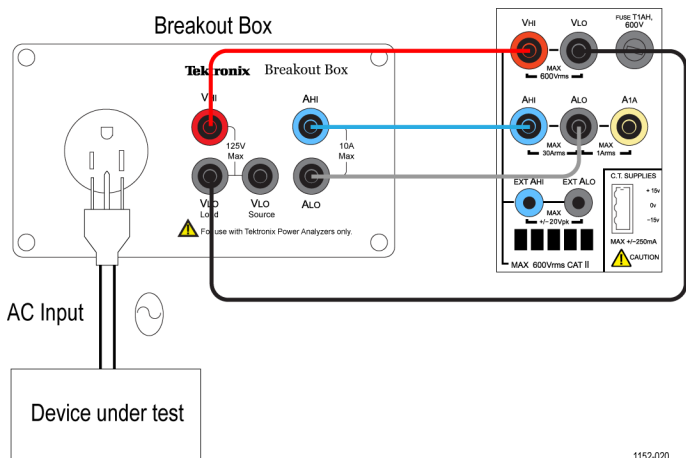







Figure 58: Inrush current measurement wiring diagram

Method 1: Inrush current measurements (PA3000 direct)

The following steps describe the process for setting up the PA3000 for the inrush current measurements.

1. Set the PA3000 to the default configuration:
 - a. Press 
 - b. Scroll down to **User Configuration** and press .
 - c. Select **Load Default Configuration**, and then press  to confirm.

The PA3000 will load the defaults and display a confirmation screen. Press  and then return to the Main Menu by pressing .

NOTE. The PA3000 needs to be configured to continuously sample and return non-averaged results. It also needs to be configured to store peak values.

2. Ranging must be fixed on both the voltage and current channels to enable continuous sampling. To select a manual range, go to the Main Menu (press ) , go to **Inputs** → **Ranging** → **Current/Voltage** range, and then select an appropriate range.

If the expected inrush current is not known, select the highest range and then dial down, as required, after repeating the test as needed for more accurate results

- The PA3000 automatically blanks all the results that are lower than ten percent of the range. Blanking is continuously active and can interfere with recording the inrush event.

To disable the blanking, go to the Main Menu, go to **System Configuration** → **Blanking** → **Off**.

- Set the averaging to one so that the results are not averaged over time. Go to the Main Menu, go to **System Configuration** → **Averaging** → **Channel Averaging**. Set the value in the window to 1.
- Turn off the Autozero function under the System Configuration menu.
- To enable Peak Hold, the Maximum and Minimum Hold columns need to be enabled. Go to the Main Menu and go to **Measurement Configuration** → **Maximum Hold** → **Enabled**. Repeat the step for the Minimum Hold.

When enabled, the Maximum and Minimum hold columns will record both positive and negative cycle peaks.

- Enable the Peak current measurement parameters in the Measurements menu. Select both the Apk+ and Apk- because the peak can be either positive or negative.
- After setting up the PA3000, connect the DUT to the breakout box.
- The inrush current will be displayed in the Max and Min columns on the Results screen. The PA3000 will hold the maximum sample value for the positive and the negative cycles.

Ch1	GROUP A			GROUP B		Result
Ch1	Ch1 Max	Ch1 Min	Ch2	Ch2		48939
Vrms	119.32 v	119.69 v	8.2379 v	Vrms	37.666 v	▲
Arms	663.25 mA	2.6777 A	0.0000 A	Arms	484.60 mA	
Watt	38.586 W	38.751 W	-12.361 mW	Watt	13.590 W	▲
Freq	59.981 Hz	59.993 Hz	0.0000 Hz	Freq	300.39 Hz	
Pf	0.4879	0.7858	-0.0189	Pf	0.7445	
Vpk+	164.12 v	164.79 v	12.148 v	Vcf	1.3735	
Vpk-	-163.90 v	-12.087 v	-164.65 v	VAcI	6.5556	
Apk+	2.5742 A	51.017 A	0.0000 A			▼
Apk-	-2.2977 A	-34.551 mA	-3.7489 A			
Vcf	1.3756	3.5877	1.3749			
AcI	3.9353	4.4122 k	0.0000			▼
						09:00P 12/15

Figure 59: Min-Max columns for the Inrush current measurement

- To reset the Max and Min values, press the RESET/CLEAR key.

Tektronix recommends to repeat the inrush current measurements by connecting the DUT several times to capture the highest possible peak value. The highest possible peak value occurs on the peak voltage cycle and it is important to capture this point for the maximum inrush current. It is also important to wait a few moments between connecting the DUT to allow the input capacitance on the device to completely discharge.

Further settings if required

Data logging. The logging feature allows you to log repeated inrush current events in the form of raw data. Use the DATA OUT key to log data onto a flash drive attached to the front panel USB connector. Turn on the data logging before first connecting the device and run the data logging through repeated plug-in events to capture all inrush events.

Screen save. The screen save function allows you to save the current screen from the PA3000. This can be useful for quickly capturing the inrush current readings. Press the SCREEN SAVE key to save the data as a .bmp file to a flash drive connected to the front panel USB connector.

Method 2: Inrush current measurements (PWRVIEW software)

The PWRVIEW software makes it easy to quickly check inrush current measurements on the measurement grid.

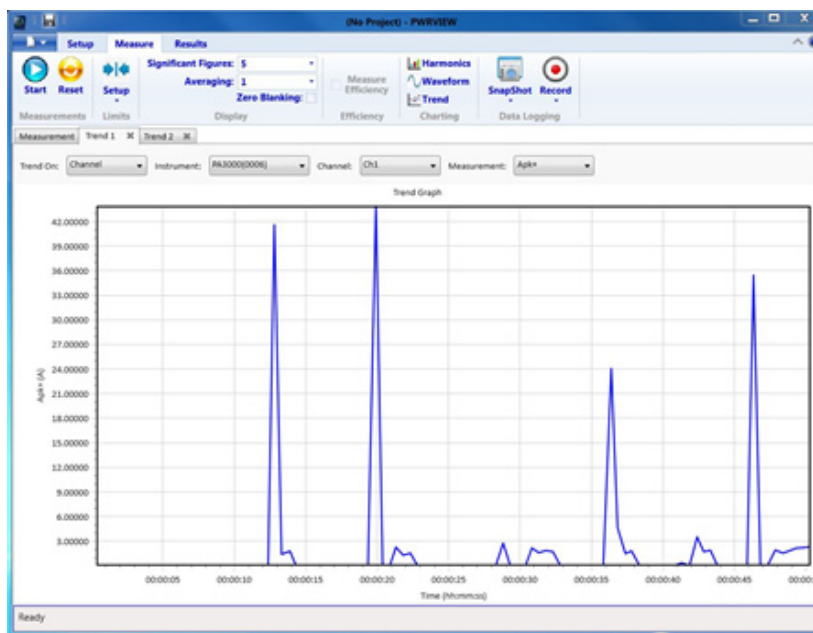

Figure 60: Inrush current measurement

1. Use the same test setup as with the preceding PA3000 direct example.
2. After making all of the power connections, connect the PA3000 to the computer with the PWRVIEW software installed using the supplied USB cable. Ethernet or GPIB can also be used, if desired.

3. Open the PWRVIEW software by double-clicking the desktop icon.
4. Click the Add button to connect the PA3000.
All available instruments will be listed in the selection panel.
5. Select the desired instrument (the PA3000) and then click Connect.
6. On the Setup page, select the Group A tab.
7. Select the highest current range from the Range selection under the Current Channel settings.
Any other range can be selected if the expected peak inrush current is known.
8. Select the Apk+ and Apk- measurements along with any other desired parameters.
9. Go to the Measure grid and clear the Zero Blanking check box in the top ribbon.
10. Select averaging of 1 from the drop-down menu for averaging.
11. Click the Start button. The measurements will start updating.
12. When the measurement grid is updating, connect the DUT to measure the inrush current.
13. Hover over the Apk+ and Apk- measurements to find the maximum positive and negative inrush current.
14. To graphically view the inrush current peak, right-click Apk+ and Apk- and then select the Trend Measurements.
The Trend chart will start updating with real time results of Apk+ and Apk- values. Connecting the DUT will graphically show the inrush current peak value.
15. To reset the Min and Max values on the Trend graph, click the Reset icon.

Tektronix recommends repeating the inrush current measurements by connecting the DUT several times to capture the highest possible peak value. The highest possible peak value occurs on the peak voltage cycle and it is important to capture this point for the maximum inrush current. It is also important to wait a few moments between connecting the DUT to allow the input capacitance on the device to completely discharge.

Further settings if required

Data logging. All instances of inrush current testing can be recorded using the Record feature of the PWRVIEW software.

- To record data using PWRVIEW, click the Record button on the menu bar. The software will start recording all the selected data including formulas and limits.
- To stop the data logging, click the Stop button.

- All the recorded data is stored in a database on the local computer. To access the data, click the Results tab and then click the Measure icon. The dialog box will present all the archived data.
- Select the desired data set and export to either an Excel or a .csv format.

Reference information

Measured parameters

Table 15: Phase measurements

Abbreviation	Description	Units	Formula ¹
V_{rms}	RMS Voltage	Volts (V)	$V_{rms} = \sqrt{\frac{1}{T} \int_0^T v^2 dt}$
A_{rms}	RMS Current	Amps (A)	$A_{rms} = \sqrt{\frac{1}{T} \int_0^T i^2 dt}$
F	Frequency	Hertz (Hz)	
W	True Power	Watts (W)	$W = \frac{1}{T} \int_0^T v i dt$
PF	Power factor		$PF = \frac{W}{V_{rms} \times A_{rms}}$
VA	Apparent Power	Volt-Amps (VA)	$VA = V_{rms} \times A_{rms}$
VA_r	Reactive Power	Volt-Amps Reactive (VAR)	$VA_r = \sqrt{(VA)^2 - W^2}$
V_{pk+}	Positive Peak Voltage	Volts (V)	$max\{v\}$
V_{pk-}	Negative Peak Voltage	Volts (V)	$min\{v\}$
A_{pk+}	Positive Peak Current	Amps (A)	$max\{i\}$
A_{pk-}	Negative Peak Current	Amps (A)	$min\{i\}$
V_{dc}	DC Voltage	Volts (V)	$V_{dc} = \frac{1}{T} \int_0^T v dt$
A_{dc}	DC Current	Amps (A)	$A_{dc} = \frac{1}{T} \int_0^T i dt$
V_{rnn}	Rectified Mean Voltage	Volts (V)	$V_{rnn} = \frac{1}{T} \int_0^T v dt$
A_{rnn}	Rectified Mean Current	Amps (A)	$A_{rnn} = \frac{1}{T} \int_0^T i dt$
V_{cf}	Voltage Crest Factor		$V_{cf} = \frac{max(V_{pk+} , V_{pk-})}{V_{rms}}$
A_{cf}	Current Crest Factor		$A_{cf} = \frac{max(A_{pk+} , A_{pk-})}{A_{rms}}$
V_{thd}	Voltage Total Harmonic Distortion	%	$\frac{\sqrt{V_{h0}^2 + V_{h2}^2 + V_{h3}^2 + V_{h4}^2 + V_{h5}^2 + \dots}}{V_{ref}}$
V_{df}	Voltage Distortion Factor	%	$\frac{\sqrt{V_{rms}^2 - V_{h1}^2}}{V_{ref}}$
V_{if}	Voltage Telephone Influence Factor		$\frac{1}{V_{ref}} \sqrt{\frac{max\ harm}{min\ harm} \sum (k_n \times V_{hn})^2}$
A_{thd}	Current Total Harmonic Distortion	%	$\frac{\sqrt{A_{h0}^2 + A_{h2}^2 + A_{h3}^2 + A_{h4}^2 + A_{h5}^2 + \dots}}{A_{ref}}$
A_{df}	Current Distortion Factor	%	$\frac{\sqrt{A_{rms}^2 - A_{h1}^2}}{A_{ref}}$

Table 15: Phase measurements (cont.)

Abbreviation	Description	Units	Formula ¹
A_{tif}	Current Telephone Influence Factor		$\frac{1}{A_{ref}} \sqrt{\sum_{\substack{max\ harm \\ min\ harm}} (k_n \times A_{hn})^2}$
Z	Impedance	Ohms (Ω)	$Z = \frac{V_f}{A_f}$
R	Resistance	Ohms (Ω)	$R = \frac{V_f}{A_f} \times \cos \theta (\theta = V_{Ph} - A_{Ph})$
X	Reactance	Ohms (Ω)	$X = \frac{V_f}{A_f} \times \sin \theta (\theta = V_{Ph} - A_{Ph})$
V_f	Fundamental Voltage	Volts (V)	$\sqrt{(V_{h1} \cdot r^2 + V_{h1} \cdot q^2)}$
A_f	Fundamental Current	Amps (A)	$\sqrt{(A_{h1} \cdot r^2 + A_{h1} \cdot q^2)}$
W_f	Fundamental Power	Watts (W)	$V_{h1} \cdot r \times A_{h1} \cdot r + V_{h1} \cdot q \times A_{h1} \cdot q$
VA_f	Fundamental Apparent Power	Volt-Amps (VA)	$\sqrt{W_f^2 + VA_{rf}^2}$
VA_r	Fundamental Reactive Power	Volt-Amps Reactive (VAR)	$\begin{aligned} & \text{if } W > 0 \\ & (V_{h1} \cdot r \times A_{h1} \cdot q) - (V_{h1} \cdot q \times A_{h1} \cdot r) \\ & \text{if } W < 0 \\ & (V_{h1} \cdot q \times A_{h1} \cdot r) - (V_{h1} \cdot r \times A_{h1} \cdot q) \end{aligned}$
PF_f	Fundamental Power Factor		$\frac{W_f}{VA_f}$
CVA_{rs}	Correction VARs	VA (VARs)	$W_f \times [\tan(\cos^{-1}(\text{Desired PF})) - \tan(\cos^{-1}(PF_f))]$
V_{hn}	Voltage harmonic n	Volts (V)	$\begin{aligned} Mag &= \sqrt{(V_{hn} \cdot r^2 + V_{hn} \cdot q^2)} \\ Phase &= \tan^{-1} \left(\frac{V_{hn} \cdot q}{V_{hn} \cdot r} \right) \end{aligned}$
A_{hn}	Current harmonic n	Amps (A)	$\begin{aligned} Mag &= \sqrt{(A_{hn} \cdot r^2 + A_{hn} \cdot q^2)} \\ Phase &= \tan^{-1} \left(\frac{A_{hn} \cdot q}{A_{hn} \cdot r} \right) \end{aligned}$
W_{hn}	Watts harmonic n	Watts (W)	$Mag = V_{hn} \times A_{hn} \times \cos(A_{hnPh} - V_{hnPh})$

¹ r = real part of V or I
q = imaginary or quadrature part of V or I
V and I are complex numbers in the form r+jq

Accuracy equations

The following table lists formulas for calculating the accuracy specification for each measurement.

In the following equations:

- It is assumed the waveform measured is a sine wave.
- V is the voltage measured in volts.
- A is the current measured in amperes.
- Θ is the phase angle in degrees (phase of the current with reference to the voltage).

Table 16: Measurement accuracy

Parameter	Description ¹
V _{cf} Accuracy	$\left(\frac{V_{pk}acc}{V_{pk}} + \frac{V_{rms}acc}{V_{rms}}\right) \times V_{cf}$ (valid for a crest factor of 1 to 10)
A _{cf} Accuracy	$\left(\frac{A_{pk}acc}{A_{pk}} + \frac{A_{rms}acc}{A_{rms}}\right) \times A_{cf}$ (valid for a crest factor of 1 to 10)
Power – W, VA, VA _r , and PF	
W Accuracy	$(V_{rms}acc \times A_{rms} \times PF) \pm (A_{rms}acc \times V_{rms} \times PF) \pm (V_{rms} \times A_{rms} \times (\cos \theta - \cos \{\theta \pm (V_{h1Ph}acc \pm A_{h1Ph}acc)\}))$
VA Accuracy	$(V_{rms}acc \times A_{rms}) + (A_{rms}acc \times V_{rms})$
VA _r Accuracy	$\sqrt{(VA^2 - [W \pm Wacc]^2)} - \sqrt{(VA^2 - W^2)}$
PF Accuracy	$\frac{Wacc}{VA}$
Fundamental Power – W _f , VA _f , VA _{rf} , and PF _f	
W _f Accuracy	$(V_{h1Mag}acc \times A_{h1Mag} \times PF_f) \pm (A_{h1Mag}acc \times V_{h1Mag} \times PF_f) \pm (V_{h1Mag} \times A_{h1Mag} \times (\cos \theta - \cos \{\theta \pm (V_{h1Ph}acc \pm A_{h1Ph}acc)\}))$
VA _f Accuracy	$(V_{h1Mag}acc \times A_{h1Mag}) + (A_{h1Mag}acc \times V_{h1Mag})$
VA _{rf} Accuracy	$\sqrt{(VA_f^2 - (W_f \pm W_facc)^2)} - \sqrt{(VA_f^2 - W_f^2)}$
PF _f Accuracy	$\frac{W_facc}{VA}$
Distortion – DF, THD, and TIF	
DF Accuracy	$\left(\frac{RMS_{acc}}{RMS} + \frac{h1Mag_{acc}}{h1Mag}\right) \div DF$
THD Accuracy	$\left(\frac{h2Mag_{acc}}{h2Mag} + \frac{h3Mag_{acc}}{h3Mag} + \frac{h4Mag_{acc}}{h4Mag} + \dots\right) \times THD$

Table 16: Measurement accuracy (cont.)

Parameter	Description ¹
TIF accuracy	$\left(\frac{h1Mag\,acc \times k_1}{h1Mag} + \frac{h3Mag\,acc \times k_3}{h3Mag} + \dots + \frac{h71Mag\,acc \times k_{71}}{h71Mag} \right) \times THD$
Impedance – Z, R, and X	
Z Accuracy	$\left(\frac{V_{rms\,acc}}{V_{rms}} + \frac{A_{rms\,acc}}{A_{rms}} \right) \times Z$
R Accuracy	$\left(\frac{V_{h1Mag\,acc}}{V_{h1Mag}} + \frac{A_{h1Mag\,acc}}{A_{h1Mag}} + \left(\tan \theta \times (V_{h1Ph\,acc} + A_{h1Ph\,acc}) \times \frac{\pi}{180} \right) \right) \times R$
X accuracy	$\left(\frac{V_{h1Mag\,acc}}{V_{h1Mag}} + \frac{A_{h1Mag\,acc}}{A_{h1Mag}} + \left(\frac{V_{h1Ph\,acc} + A_{h1Ph\,acc}}{\tan \theta} \times \frac{\pi}{180} \right) \right) \times X$

¹ “acc” represents accuracy in the equations.

Sum equations

The following tables list different equations that can be used for summing voltage and current values; the voltage methods are unrelated to the current methods.

The equations depend on the wiring configurations. In some cases there are two methods of using the sum voltage and sum current formulas: Method 1 or Method 2, as shown in the following tables. Use the method that meets your needs.

Table 17: One phase, three wire sum equations

$\sum V_{rms} = ch1V_{rms} + ch2V_{rms}$	
$\sum A_{rms} = \frac{\sum VA}{\sum V_{rms}}$	Method 1
$\sum A_{rms} = \frac{ch1A_{rms} + ch2A_{rms}}{2}$	Method 2
$\sum W = ch1W + ch2W$	
$\sum VA_r = \sqrt{(\sum VA_{rf})^2 + \left(\sqrt{ch1VA_r^2 - ch1VA_{rf}^2} + \sqrt{ch2VA_r^2 - ch2VA_{rf}^2} \right)^2}$	
$\sum VA = \sqrt{(\sum W)^2 + (\sum VA_r)^2}$	
$\sum PF = \frac{\sum W}{\sum VA}$	
$\sum V_f = ch1V_f + ch2V_f$	
$\sum A_f = \frac{ch1A_f \times ch1V_f + ch2A_f \times ch2V_f}{\sum V_f}$	Method 1
$\sum A_f = \frac{ch1A_f + ch2A_f}{2}$	Method 2
$\sum W_f = ch1W_f + ch2W_f$	
$\sum VA_{rf} = ch1VA_{rf} + ch2VA_{rf}$	
$\sum VA_f = \sqrt{(\sum W_f)^2 + (\sum VA_{rf})^2}$	
$\sum PF_f = \frac{\sum W_f}{\sum VA_f}$	

Table 17: One phase, three wire sum equations (cont.)

$\sum V_{dc} = ch1V_{dc} + ch2V_{dc}$	
$\sum A_{dc} = \frac{ch1A_{dc} \times ch1V_{dc} + ch2A_{dc} \times ch2V_{dc}}{\sum V_{dc}}$	Method 1
$\sum A_{dc} = \frac{ch1A_{dc} + ch2A_{dc}}{2}$	Method 2
$\sum V_{rmn} = ch1V_{rmn} + ch2V_{rmn}$	
$\sum A_{rmn} = \frac{ch1A_{rmn} \times ch1V_{rmn} + ch2A_{rmn} \times ch2V_{rmn}}{\sum V_{rmn}}$	Method 1
$\sum A_{rmn} = \frac{ch1A_{rmn} + ch2A_{rmn}}{2}$	Method 2
$\sum V_{cmn} = ch1V_{cmn} + ch2V_{cmn}$	
$\sum A_{cmn} = \frac{ch1A_{cmn} \times ch1V_{cmn} + ch2A_{cmn} \times ch2V_{cmn}}{\sum V_{cmn}}$	Method 1
$\sum A_{cmn} = \frac{ch1A_{cmn} + ch2A_{cmn}}{2}$	Method 2
$\sum WHr = ch1WHr + ch2WHr$	
$\sum AHR = \frac{ch1AHR + ch2AHR}{2}$	
$\sum VA_r H_f = ch1VA_r H_f + ch2VA_r H_f$	
$\sum VA_r Hr = \sqrt{(\sum VA_r H_f)^2 + \left(\sqrt{ch1VA_r Hr^2 - ch1VA_r H_f^2} + \sqrt{ch2VA_r Hr^2 - ch2VA_r H_f^2} \right)^2}$	
$\sum VAHR = \sqrt{(\sum WHr)^2 + (\sum VA_r Hr)^2}$	
$\sum W_{av} = ch1W_{av} + ch2W_{av}$	
$\sum PF_{av} = \frac{\sum WHr}{\sum VAHR}$	

Table 18: Three phase, three wire sum equations

$\sum V_{rms} = \frac{ch1V_{rms} + ch2V_{rms}}{2}$	Method 1
$\sum V_{rms} = \sqrt{3} \frac{ch1V_{rms} + ch2V_{rms}}{2}$	Method 2
$\sum A_{rms} = \frac{\sum VA}{\sqrt{3} \sum V_{rms}}$	Method 1
$\sum A_{rms} = \frac{ch1A_{rms} + ch2A_{rms}}{2}$	Method 2
$\sum W = ch1W + ch2W$	
$\sum VA_r = \sqrt{(\sum VA_{rf})^2 + \sqrt{\frac{3}{2}} \left(\sqrt{ch1VA_r^2 - ch1VA_{rf}^2} + \sqrt{ch2VA_r^2 - ch2VA_{rf}^2} \right)^2}$	
$\sum VA = \sqrt{(\sum W)^2 + (\sum VA_r)^2}$	
$\sum PF = \frac{\sum W}{\sum VA}$	
$\sum V_f = \frac{ch1V_f + ch2V_f}{2}$	Method 1
$\sum V_f = \sqrt{3} \frac{ch1V_f + ch2V_f}{2}$	Method 2

Table 18: Three phase, three wire sum equations (cont.)

$\sum A_f = \frac{ch1A_f \times ch1V_f + ch2A_f \times ch2V_f}{\sqrt{3} \sum V_f}$	Method 1
$\sum A_f = \frac{ch1A_f + ch2A_f}{2}$	Method 2
$\sum W_f = ch1W_f + ch2W_f$	
$\sum VA_{rf} = ch1VA_{rf} + ch2VA_{rf}$	
$\sum VA_f = \sqrt{(\sum W_f)^2 + (\sum VA_{rf})^2}$	
$\sum PF_f = \frac{\sum W_f}{\sum VA_f}$	
$\sum V_{dc} = \frac{ch1V_{dc} + ch2V_{dc}}{2}$	Method 1
$\sum V_{dc} = \sqrt{3} \frac{ch1V_{dc} + ch2V_{dc}}{2}$	Method 2
$\sum A_{dc} = \frac{ch1A_{dc} \times ch1V_{dc} + ch2A_{dc} \times ch2V_{dc}}{\sqrt{3} \sum V_{dc}}$	Method 1
$\sum A_{dc} = \frac{ch1A_{dc} + ch2A_{dc}}{2}$	Method 2
$\sum V_{rmn} = \frac{ch1V_{rmn} + ch2V_{rmn}}{2}$	Method 1
$\sum V_{rmn} = \sqrt{3} \frac{ch1V_{rmn} + ch2V_{rmn}}{2}$	Method 2
$\sum A_{rmn} = \frac{ch1A_{rmn} \times ch1V_{rmn} + ch2A_{rmn} \times ch2V_{rmn}}{\sqrt{3} \sum V_{rmn}}$	Method 1
$\sum A_{rmn} = \frac{ch1A_{rmn} + ch2A_{rmn}}{2}$	Method 2
$\sum V_{cmn} = \frac{ch1V_{cmn} + ch2V_{cmn}}{2}$	Method 1
$\sum V_{cmn} = \sqrt{3} \frac{ch1V_{cmn} + ch2V_{cmn}}{2}$	Method 2
$\sum A_{cmn} = \frac{ch1A_{cmn} \times ch1V_{cmn} + ch2A_{cmn} \times ch2V_{cmn}}{\sqrt{3} \sum V_{cmn}}$	Method 1
$\sum A_{cmn} = \frac{ch1A_{cmn} + ch2A_{cmn}}{2}$	Method 2
$\sum WHr = ch1WHr + ch2WHr$	
$\sum AHR = \frac{ch1AHR + ch2AHR}{2}$	
$\sum VA_r H_f = ch1VA_r H_f + ch2VA_r H_f$	
$\sum VA_r Hr = \sqrt{(\sum VA_r H_f)^2 + \sqrt{\frac{3}{2}} \left(\sqrt{ch1VA_r Hr^2 - ch1VA_r H_f^2} + \sqrt{ch2VA_r Hr^2 - ch2VA_r H_f^2} \right)^2}$	
$\sum VAHr = \sqrt{(\sum WHr)^2 + (\sum VA_r Hr)^2}$	
$\sum W_{av} = ch1W_{av} + ch2W_{av}$	
$\sum PF_{av} = \frac{\sum WHr}{\sum VAHr}$	

Table 19: Three phase, four wire sum equations

$\sum V_{rms} = \frac{ch1V_{rms} + ch2V_{rms} + ch3V_{rms}}{\sqrt{3}}$	Method 1
$\sum V_{rms} = \frac{ch1V_{rms} + ch2V_{rms} + ch3V_{rms}}{3}$	Method 2

Table 19: Three phase, four wire sum equations (cont.)

$\sum A_{rms} = \frac{\sum VA}{\sqrt{3} \sum V_{rms}}$	Method 1
$\sum A_{rms} = \frac{ch1A_{rms} + ch2A_{rms} + ch3A_{rms}}{3}$	Method 2
$\sum W = ch1W + ch2W + ch3W$	
$\sum VA_r = \sqrt{(\sum VA_{rf})^2 + \left(\sqrt{ch1VA_r^2 - ch1VA_{rf}^2} + \sqrt{ch2VA_r^2 - ch2VA_{rf}^2} + \sqrt{ch3VA_r^2 - ch3VA_{rf}^2} \right)^2}$	
$\sum VA = \sqrt{(\sum W)^2 + (\sum VA_r)^2}$	
$\sum PF = \frac{\sum W}{\sum VA}$	
$\sum V_f = \frac{ch1V_f + ch2V_f + ch3V_f}{\sqrt{3}}$	Method 1
$\sum V_f = \frac{ch1V_f + ch2V_f + ch3V_f}{3}$	Method 2
$\sum A_f = \frac{ch1A_f \times ch1V_f + ch2A_f \times ch2V_f + ch3A_f \times ch3V_f}{\sqrt{3} \sum V_f}$	Method 1
$\sum A_f = \frac{ch1A_f + ch2A_f + ch3A_f}{3}$	Method 2
$\sum W_f = ch1W_f + ch2W_f + ch3W_f$	
$\sum VA_{rf} = ch1VA_{rf} + ch2VA_{rf} + ch3VA_{rf}$	
$\sum VA_f = \sqrt{(\sum W_f)^2 + (\sum VA_{rf})^2}$	
$\sum PF_f = \frac{\sum W_f}{\sum VA_f}$	
$\sum V_{dc} = \frac{ch1V_{dc} + ch2V_{dc} + ch3V_{dc}}{\sqrt{3}}$	Method 1
$\sum V_{dc} = \frac{ch1V_{dc} + ch2V_{dc} + ch3V_{dc}}{3}$	Method 2
$\sum A_{dc} = \frac{ch1A_{dc} \times ch1V_{dc} + ch2A_{dc} \times ch2V_{dc} + ch3A_{dc} \times ch3V_{dc}}{\sqrt{3} \sum V_{dc}}$	Method 1
$\sum A_{dc} = \frac{ch1A_{dc} + ch2A_{dc} + ch3A_{dc}}{3}$	Method 2
$\sum V_{rmn} = \frac{ch1V_{rmn} + ch2V_{rmn} + ch3V_{rmn}}{\sqrt{3}}$	Method 1
$\sum V_{rmn} = \frac{ch1V_{rmn} + ch2V_{rmn} + ch3V_{rmn}}{3}$	Method 2
$\sum A_{rmn} = \frac{ch1A_{rmn} \times ch1V_{rmn} + ch2A_{rmn} \times ch2V_{rmn} + ch3A_{rmn} \times ch3V_{rmn}}{\sqrt{3} \sum V_{rmn}}$	Method 1
$\sum A_{rmn} = \frac{ch1A_{rmn} + ch2A_{rmn} + ch3A_{rmn}}{3}$	Method 2
$\sum V_{cmn} = \frac{ch1V_{cmn} + ch2V_{cmn} + ch3V_{cmn}}{\sqrt{3}}$	Method 1
$\sum V_{cmn} = \frac{ch1V_{cmn} + ch2V_{cmn} + ch3V_{cmn}}{3}$	Method 2
$\sum A_{cmn} = \frac{ch1A_{cmn} \times ch1V_{cmn} + ch2A_{cmn} \times ch2V_{cmn} + ch3A_{cmn} \times ch3V_{cmn}}{\sqrt{3} \sum V_{cmn}}$	Method 1
$\sum A_{cmn} = \frac{ch1A_{cmn} + ch2A_{cmn} + ch3A_{cmn}}{3}$	Method 2
$\sum WHr = ch1WHr + ch2WHr + ch3WHr$	
$\sum AHR = \frac{ch1AHR + ch2AHR + ch3AHR}{3}$	

Table 19: Three phase, four wire sum equations (cont.)

$$\sum VA_r H_f = ch1VA_r H_f + ch2VA_r H_f + ch3VA_r H_f$$

$$\sum VA_r Hr = \sqrt{(\sum VA_r H_f)^2 + \left(\sqrt{ch1VA_r Hr^2 - ch1VA_r H_f^2} + \sqrt{ch2VA_r Hr^2 - ch2VA_r H_f^2} + \sqrt{ch3VA_r Hr^2 - ch3VA_r H_f^2}\right)^2}$$

$$\sum VAHr = \sqrt{(\sum WHr)^2 + (\sum VA_r Hr)^2}$$

$$\sum W_{av} = ch1W_{av} + ch2W_{av} + ch3W_{av}$$

$$\sum PF_{av} = \frac{\sum WHr}{\sum VAHr}$$

Communication ports

The PA3000 is fitted with RS-232, Ethernet, and USB as standard. GPIB is available as an option. A USB host port is located on the front panel; other communication ports are located on the rear panel.

- Front panel USB host port**
- Single port on the front panel
 - USB 2.0 compatible
 - 250 mA, +5 V supply

Table 20: USB connector pin descriptions

Pin	Description
1	+5 V
2	Data (D-)
3	Data (D+)
4	Ground

USB Flash Drive Requirements:

- The USB flash drive must be formatted with FAT12, FAT16 or FAT32 file systems.
- Sector size must be 512 bytes. Cluster size up to 32 kB.
- Only Bulk Only Mass Storage (BOMS) devices which support the SCSI or AT command sets are supported. For more information on BOMS devices refer to Universal Serial Bus Mass Storage Class – Bulk Only Transport Rev. 1.0, published by the USB Implementers Forum.

Rear panel communication ports

The following figure and table describe the communication ports located on the rear panel of the power analyzer.

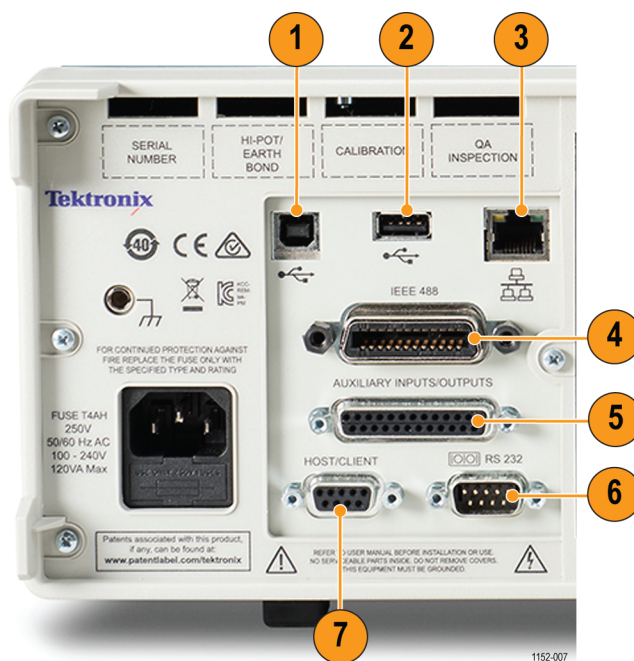

Figure 61: Power analyzer communication ports on the rear panel

Table 21: Communication ports on the rear panel

Item	Description
1	USB peripheral. Connects the power analyzer to a host PC.
2	USB host port (Unused)
3	Ethernet port
4	GPIB port (Optional)
5	Auxiliary port
6	RS-232 port
7	Host/Client port (Unused)

USB peripheral port.

- USB 2.0 compatible
- Full Speed (12 Mbits/s)

Ethernet port.

- IEEE 802.3 compatible, 10Base-T
- Connector: RJ-45 with Link and Activity indicators

- TCP/IP connection on port 5025
- DST connection on port 5030

Table 22: Ethernet pin descriptions

Pin	Signal name
1	Data (Tx+)
2	Data (Tx-)
3	Data (Rx+)
4	Ground
5	Ground
6	Data (Rx-)
7	Ground
8	Ground

IEEE 488 / GPIB (Optional). The IEEE 488 port is compatible with normal GPIB cables that will work with the PA3000.

Table 23: GPIB port pin configuration descriptions

Pin	Signal name	Pin	Signal name
1	Data 1	13	Data 5
2	Data 2	14	Data 6
3	Data 3	15	Data 7
4	Data 4	16	Data 8
5	End or Identify (EOI)	17	Remote Enable (REN)
6	Data Valid (DAV)	18	Ground
7	Not Ready For Data (NRFD)	19	Ground
8	Not Data Accepted (NDAC)	20	Ground
9	Interface Clear (IFC)	21	Ground
10	Service Request (SRQ)	22	Ground
11	Attention (ATN)	23	Ground
12	Shield Ground	24	Ground

Auxiliary inputs/outputs.

The PA3000 is fitted with a number of auxiliary inputs and outputs. They are:

- 4 analog inputs
- 2 counter inputs
- 4 digital outputs

The pin connections on the auxiliary connect are:

Table 24: Auxiliary input-output pin descriptions

Pin	Signal name	Pin	Signal name
1	Analog Input 1	7	Digital Output 3
2	Analog Input 2	8	Digital Output 4
3	Analog Input 3	9	Counter Input 1
4	Analog Input 4	10	Counter Input 2
5	Digital Output 1		
6	Digital Output 2		

Pins 11 through 22 are connected to ground. Pins 23 through 25 have no connection.

Serial port.

- 9-pin male D-type connector on rear of instrument
- RS-232 interface for connection to a PC for remote control with a straight through cable
- Available baud rates 9600, 19200, and 38400 (default)
- 8 data bits, no parity, one stop bit, hardware flow control

Table 25: RS-232 connector pin descriptions

Pin	I/O	Signal name	Pin	I/O	Signal name
1		No connection	6		No connection
2	Out	TXD	7	In	RTS
3	In	RXD	8	Out	CTS
4		No connection	9		No connection
5		Ground			

Index

A

- accuracy equations, 141
- :ANA, 88
- analog inputs, 53
- analog inputs command, 88
- application examples, 103
 - efficiency measurements, 104
- autozero, 60
- autozero command, 93
- auxiliary inputs/outputs, 149
- averaging, 59
- averaging command, 92
- :AVG, 92

B

- ballast mode, 42
- ballast mode command, 79
- bandwidth command, 87
- Bar chart screen, 15
- basic installation, 1
- baud rate, 54
- :BDW, 87
- blanking, 59
- blanking command, 92
- :BLK, 92
- .bmp file, 24
- built-in current shunts, 29

C

- :CAL:DATE?, 70
- calibration date command, 70
- card type command, 70
- :CFG:USER, 95
- channel and group commands, 69
 - :INST:NSEL, 69
 - :INST:NSEL?, 69
 - :INST:NSELC, 69
 - :INST:NSELC?, 69
- channel settings, 4
- *CLS, 67
- :COM:ETH, 89
- :COM:ETH:MAC, 90
- :COM:ETH:STAT, 89

- :COM:IEE, 89
- :COM:RS2, 89
- command listing, 66
- command syntax, 66
- commands
 - sending and receiving, 96
- communications ports, 146
 - Ethernet port, 147
 - IEEE 488/GPIB, 148
 - serial port, 149
 - USB host, 146
 - USB peripheral, 147
- configuring measurements, 38
- connecting signals, 28
- connection sequence, 2
- connections
 - current transformer, 30
 - resistive shunt, 31
 - to the product under test, 4
 - transducer with voltage input, 33
 - voltage transformer, 34
- controls and connectors
 - front panel, 11
- current scaling, 30
- current shunts, 29
- current transformer
 - connections, 30
 - current scaling, 30

D

- data format, 26
- data storage, 26
- :DATA:USB, 90
- datalog, 56
- datalog commands, 90
 - :DATA:USB, 90
 - :MATH?, 92
 - :MATH:FUNC, 91
 - :MATH:FUNC:EN, 91
- dead socket connection, 55
- :DISP:DATA?, 91
- display data command, 91

- display phase angle command, 76
- distortion factor, 39
- distortion factor setup
 - command, 75
- distortion setup, 39
- :DSE, 68
- :DSE?, 68
- :DSR?, 68
- DST, 55
- :DVC, 68

E

- entering alphabetical characters, 25
- equations
 - accuracy, 141
- *ESE, 67
- *ESE?, 67
- *ESR?, 67
- Ethernet configuration, 54
 - dead socket connection, 55
- Ethernet MAC address
 - command, 90
- Ethernet port, 147
- examples
 - choosing measurements to display, 8
 - harmonics, 98
 - returning results
 - repeatedly, 97
 - selecting and returning results, 97
 - using a group of channels, 98
- external current inputs, 29
- external transducers, 35

F

- features and abilities, xvii
- firmware version, 21
- :FRD?, 74
- frequency settings command, 85
- Frequency Source menu, 51
- :FRF?, 73

front panel
 alphabetical keys, 24
 Bar chart screen, 15
 controls and connectors, 11
 formula keys, 25
 Help key, 24
 Integrator screen, 17
 Math screen, 20
 Menu key, 24
 number keys, 25
 operation, 11
 operational keys, 24
 quick view keys, 12
 Results screen, 13
 Setup screens, 21
 soft keys, 23
 USB port, 22
 Vector screen, 19
 Waveform screen, 14
:FSR, 85

G

getting started, 1
global
 settings, 3
GPIB, 54
GPIB commands, 67
GPIB configuration command, 89
graph and waveform
 commands, 88
graphs, 53
graphs and waveforms, 53
 integrator parameters, 53
 waveforms, 53
group
 definition, 3
 settings, 3
group name command, 83

H

hard keys
 left and right, 7
harmonics configuration
 command, 74

harmonics setup, 39
help key, 9
:HMX:VLT/AMP, 74
:HMX:VLT/AMP:DF, 75
:HMX:VLT/AMP:PHA, 76
:HMX:VLT?AMP:THD, 76
:HMX:VLT/AMP:TIF, 77

I

*IDN?, 67
IEEE 488 / GPIB port, 148
IEEE 488.2
 standard commands, 67
 status commands, 67
input setup commands, 83
 :ANA, 88
 :BDW, 87
 :FSR, 85
 :NAME, 83
 :RNG, 84
 :SCL, 87
 :SHU, 85
 :WRG, 83
inputs, 47
 analog inputs, 53
 bandwidth, 52
 current, 29
 external current, 29
 fixed/auto ranging, 50
 frequency source, 51
 ranges, 50
 ranging, 50
 scale, 52
 shunts, 51
 voltage, 29
 wiring, 47
:INST:NSEL, 69
:INST:NSEL?, 69
:INST:NSELC, 69
:INST:NSELC?, 69
Integrator Graph menu, 53
integrator mode, 43
 configuring, 44
integrator mode command, 80

Integrator screen, 17
interface commands, 89
 :COM:ETH, 89
 :COM:ETH:MAC, 90
 :COM:ETH:STAT, 89
 :COM:IEE, 89
 :COM:RS2, 89
 :WAV, 88
interfaces, 54
 Ethernet configuration, 54
 GPIB address, 54
 RS-232 baud rate, 54
internal clock, 60

L

left and right hard keys, 7
Line-to-Line measurements, 49
Line-to-Neutral
 measurements, 49
logging data, 26
logging data to a memory
 device, 26
logging interval
 configuring, 56

M

math commands, 91
math function enable
 command, 91
math function information
 command, 91
math results, 56
Math screen, 20
:MATH?, 92
:MATH:FUNC, 91
:MATH:FUNC:EN, 91
:MAX, 78
maximum column command, 78
maximum hold columns, 41
measured parameters, 139

- measurement configuration
 - commands, 74
 - :HMX:VLT/AMP, 74
 - :HMX:VLT/AMP:DF, 75
 - :HMX:VLT/AMP:PHA, 76
 - :HMX:VLT?AMP:THD, 76
 - :HMX:VLT/AMP:TIF, 77
 - :MAX, 78
 - :MIN, 77
 - :SUM, 78
 - Measurement Configuration
 - menu, 38
 - measurement reading
 - commands, 70
 - measurement selection and reading commands
 - :FRD?, 74
 - :FRF?, 73
 - :MOVE, 73
 - :SEL, 71
 - measurement selection
 - commands, 70
 - measurements
 - configuration, 38
 - distortion set up, 39
 - harmonics setup, 39
 - maximum hold columns, 41
 - minimum hold columns, 41
 - sum current formulas, 42
 - sum results column, 41
 - sum voltage formulas, 42
 - Measurements menu, 36
 - menu system
 - measurements, 36
 - :MIN, 77
 - minimum column command, 77
 - minimum hold columns, 41
 - :MOD, 79
 - :MOD:BAL, 79
 - :MOD:INT, 80
 - :MOD:PWM, 82
 - :MOD:SBY, 80
 - mode command, 79
 - mode setup commands, 79, 80
 - :MOD, 79
 - :MOD:BAL, 79
 - :MOD:PWM, 82
 - :MOD:SBY, 80
 - modes, 42
 - ballast, 42
 - integrator, 43
 - normal, 42
 - PWM motor, 46
 - standby power, 43
 - :MOVE, 73
 - move results command, 73
- N**
- :NAME, 83
 - navigating the menu system, 8
 - navigating the Results screen, 7
 - normal mode, 42
- O**
- on-screen help, 9
- P**
- power for external transducers, 35
 - power on, 2
 - power usage command, 95
 - PWM motor mode, 46
 - PWM motor mode command, 82
- Q**
- quick view keys, 12
- R**
- ranging command, 84
 - read active group command, 69
 - read foreground data
 - command, 74
 - read selected results command, 73
 - rear panel
 - inputs, 28
- remote operation**
- interfacing with Ethernet systems, 62
 - interfacing with GPIB systems, 63
 - interfacing with RS-232 systems, 62
 - interfacing with USB systems, 62
 - overview, 62
- resistive shunt**
- connections, 31
- Results screen, 6, 13
- return active channel
 - command, 69
- return Ethernet configuration
 - command, 89
- return math results command, 92
- :RNG, 84
- RS-232 configuration
 - command, 89
- *RST, 68
- S**
- scaling command, 87
 - :SCL, 87
 - screen capture, 24
 - screen save commands
 - :DISP:DATA?, 91
 - :SEL, 71
 - select active channel
 - command, 69
 - select results command, 71
 - serial number, 21
 - serial port, 149
 - set active group command, 69
 - Setup screens, 21
 - shift key, 25
 - :SHU, 85
 - shunt selection command, 85
 - shunts
 - inputs, 51
 - soft keys, 23
 - software
 - PA3000 download software, 101
 - updating firmware, 101

- standby mode command, 80
 - standby power mode, 43
 - starting integration, 45
 - Static Ethernet configuration
 - command, 89
 - status reporting, 63
 - display data status enable register, 64
 - display data status register, 64
 - standard event status enable register, 65
 - standard event status register, 65
 - status byte, 63
 - status byte register, 64
 - *STB?, 68
 - stopping integration, 45
 - :SUM, 78
 - sum current formulas, 42
 - sum equations
 - one phase, three wire, 142
 - three phase, four wire, 144
 - three phase, three wire, 143
 - sum results column, 41
 - sum results command, 78
 - sum voltage formulas, 42
 - :SYST:CTYPE?, 70
 - :SYST:DATE, 94
 - :SYST:POWER, 95
 - :SYST:TIME, 94
 - :SYST:ZERO, 93
 - system configuration
 - analyzer configuration, 61
 - autozero, 60
 - averaging, 59
 - blanking, 59
 - clock, 60
 - power saving, 60
 - update rate, 60
 - system configuration commands, 92
 - :AVG, 92
 - :BLK, 92
 - :SYST:DATE, 94
 - :SYST:POWER, 95
 - :SYST:TIME, 94
 - :SYST:ZERO, 93
 - :UPDATE, 93
 - system date command, 94
 - system time command, 94
- T**
- telephone influence factor, 40
 - telephone influence factor setup command, 77
 - THD, 40
 - TIF, 40
 - total harmonic distortion, 40
 - total harmonic distortion setup command, 76
 - transducer
 - connections, 33
- U**
- unit information commands, 70
 - :CAL:DATE?, 70
 - :SYST:CTYPE?, 70
- V**
- Vector screen, 19
 - voltage scaling, 34
 - voltage transducer
 - connections, 34
 - voltage scaling, 34
 - voltage transformer
 - voltage scaling, 34
- W**
- :WAV, 88
 - Waveform screen, 14
 - waveforms, 53
 - wiring configuration
 - command, 83
 - wiring configurations, 47
 - :WRG, 83
- :UPDATE, 93
 - update rate, 60
 - update rate command, 93
 - USB data logging command, 90
 - USB Flash Drive
 - Requirements, 146
 - USB host port, 146
 - USB peripheral port, 147
 - USB port, 22
 - User Configuration
 - default configuration, 61
 - load from USB, 61
 - preset configuration, 61
 - save to USB, 61
 - user configuration commands, 95
 - :CFG:USER, 95
 - User Configuration menu, 61
 - user configurations command, 95