

R&S® Scope Rider RTH Handheld Oscilloscope User Manual



This manual describes the following R&S®RTH models with firmware version 1.80:

- R&S®RTH1004 (1317.5000K04)
- R&S®RTH1002 (1317.5000K02)

In addition to the base unit, the following options are described:

- R&S®RTH-K1 I2C/SPI triggering and decoding (1325.9969.02)
- R&S®RTH-K2 UART/RS232 triggering and decoding (1325.9975.02)
- R&S®RTH-K3 CAN/LIN triggering & decoding (1333.0550.02)
- R&S®RTH-K9 CAN FD triggering & decoding (1326.3829.02)
- R&S®RTH-K10 SENT triggering & decoding (1326.3835.02)
- R&S®RTH-K15 History and segmented memory (1326.1803.02)
- R&S®RTH-K18 Spectrum analysis (1333.0680.02)
- R&S®RTH-K19 Advanced trigger (1326.0642.02)
- R&S®RTH-B1 Mixed signal option (1325.9981.02)
- R&S®RTH-K33 Frequency counter (1333.0696.02)
- R&S®RTH-K34 Harmonic analysis (1333.0673.02)
- R&S®RTH-K38 User scripting (1801.4632.02)

© 2019 Rohde & Schwarz GmbH & Co. KG

Mühlhofstr. 15, 81671 München, Germany

Phone: +49 89 41 29 - 0

Fax: +49 89 41 29 12 164

Email: info@rohde-schwarz.com

Internet: www.rohde-schwarz.com

Subject to change – Data without tolerance limits is not binding.

R&S® is a registered trademark of Rohde & Schwarz GmbH & Co. KG.

Trade names are trademarks of the owners.

1326.1578.02 | Version 14 | R&S®Scope Rider RTH

Throughout this manual, products from Rohde & Schwarz are indicated without the ® symbol, e.g. R&S®Scope Rider RTH is indicated as R&S RTH.

Contents

1	For Your Safety	7
2	Getting Started	9
2.1	Preface.....	9
2.2	Preparing for Use.....	11
2.3	Instrument Tour.....	17
2.4	Operating Basics.....	23
2.5	Maintenance.....	36
3	Waveform Setup	40
3.1	Connecting Probes.....	40
3.2	Vertical Setup.....	41
3.3	Horizontal Setup.....	46
3.4	Acquisition Control.....	48
3.5	Roll Mode.....	51
3.6	Trigger.....	52
4	Waveform Analysis	79
4.1	Zoom.....	79
4.2	Automatic Measurements.....	81
4.3	Cursor Measurements.....	88
4.4	Mathematics.....	92
4.5	Reference Waveforms.....	94
4.6	XY-Diagram.....	98
4.7	History (Option R&S RTH-K15).....	99
5	Mask Testing	105
5.1	Accessing the Mask Mode.....	105
5.2	Mask Test Results.....	105
5.3	Running Mask Tests.....	106
5.4	Mask Settings.....	107
6	Spectrum Analysis	110
6.1	FFT Mode.....	110
6.2	Spectrum Mode (Option R&S RTH-K18).....	117

6.3	Harmonics Measurement (Option R&S RTH-K34).....	134
7	Multimeter Measurements.....	147
7.1	Digital Multimeter (R&S RTH1002).....	147
7.2	Voltmeter (R&S RTH1004).....	152
8	Data Logging.....	159
8.1	Accessing the Logger Mode.....	159
8.2	Logger Display.....	159
8.3	Using the Logger.....	160
8.4	Logger Settings.....	163
8.5	Analyzing Logged Data.....	165
8.6	Export of Logger Records.....	170
9	Protocol Analysis.....	175
9.1	Basics of Protocol Analysis.....	175
9.2	I2C (Option R&S RTH-K1).....	183
9.3	SPI (Option R&S RTH-K1).....	192
9.4	UART/RS-232/RS-422/RS-485 (Option R&S RTH-K2).....	199
9.5	CAN and CAN FD (Options R&S RTH-K3, R&S RTH-K9).....	206
9.6	LIN (Option R&S RTH-K3).....	221
9.7	SENT (Option R&S RTH-K10).....	230
10	Logic Analyzer (R&S RTH-B1 MSO).....	254
10.1	Logic Analyzer Settings.....	254
10.2	Triggering on Logic Channels.....	257
10.3	Analyzing Logic Channels.....	257
11	Frequency Counter (R&S RTH-K33).....	259
11.1	Accessing the Counter Mode.....	259
11.2	Display and Control.....	260
11.3	Performing a Counter Measurement.....	263
11.4	Counter Settings.....	265
12	Documenting Results.....	268
12.1	Using USB Flash Drive.....	268
12.2	Filesystem Tools.....	269

12.3	Instrument Settings.....	271
12.4	Waveforms.....	273
12.5	Logger Records.....	280
12.6	Quick Save with OneTouch.....	280
12.7	Screenshots.....	281
13	General Instrument Setup.....	284
13.1	Resetting the Instrument.....	284
13.2	Disabling the Touchscreen.....	284
13.3	Selfalignment.....	284
13.4	Setting the Date, Time and Language.....	286
13.5	Instrument Settings.....	287
13.6	Display Settings.....	289
13.7	Options.....	291
13.8	Updating the Firmware.....	293
14	Network Connections.....	295
14.1	LAN Connection.....	295
14.2	USB connection.....	297
14.3	Web File Browser.....	297
14.4	Wireless LAN Connection (Option R&S RTH-K200/200US).....	299
14.5	Web Interface (Option R&S RTH-K201).....	302
15	Remote Control Commands.....	303
15.1	Conventions used in Command Description.....	303
15.2	Mode.....	303
15.3	Waveform Setup.....	304
15.4	Waveform Analysis.....	339
15.5	Mask Testing.....	353
15.6	Spectrum Analysis.....	357
15.7	Digital Multimeter (R&S RTH1002).....	383
15.8	Voltmeter (R&S RTH1004).....	399
15.9	Counter Mode (R&S RTH-K33).....	411
15.10	Data Logging.....	418
15.11	Protocol Analysis.....	430

15.12	Logic Analyzer (R&S RTH-B1 MSO).....	491
15.13	Documenting Results.....	494
15.14	General Instrument Setup.....	506
15.15	WLAN Connection (Option R&S RTH-K200/200US).....	508
15.16	User Scripting (R&S RTH-K38).....	509
	Annex.....	510
	A SCPI Command Structure.....	510
A.1	Syntax for Common Commands.....	510
A.2	Syntax for Device-Specific Commands.....	511
A.3	SCPI Parameters.....	513
A.4	Overview of Syntax Elements.....	516
A.5	Structure of a Command Line.....	517
A.6	Responses to Queries.....	518
	B Command Sequence and Synchronization.....	519
B.1	Preventing Overlapping Execution.....	519
	C User Scripting (R&S RTH-K38).....	521
C.1	Loading User Apps to the Instrument.....	521
C.2	Running User Apps.....	521
C.3	About User Apps.....	522
C.4	Demo App.....	523
	List of Commands.....	527

1 For Your Safety

To prevent electric shock, personal injury, or fire caused by high voltages, carefully read and observe the following safety information:

- This chapter, the first part of the safety booklet, provides warnings and safety information for usage of oscilloscopes, probes, and other measurement accessories.
- The second part of the safety booklet provides basic safety instructions
- Product manuals provide specific safety instructions for procedures and measurement accessories.

Electrical safety

- Voltages higher than 30 V RMS, or 42 V peak, or 60 V DC are regarded as hazardous contact voltages. When working with hazardous contact voltages, use protective measures to preclude direct contact with the measurement setup:
 - Do not touch exposed connections and components when power is applied.
 - Use only insulated voltage probes, test leads and adapters.
- Make sure that only personnel familiar with the potential risks of measuring electrical quantities controls the instrument. Observe applicable local or national safety regulations and rules for the prevention of accidents.
- Use only specified probes and accessories that comply with the measurement category (CAT) of your measurement task. If you use other than Rohde & Schwarz accessories, make sure that they are suitable for the instrument and the measurement task.
- Observe all voltage and current ratings of the instrument, the probes, and the accessories. The lowest rated component defines the rating of the complete measurement setup. Limits and ratings are marked on the products and listed in the data sheets.

For probes, consider that the rated voltage depends on the frequency. The voltage limitation curves are provided in the data sheet. Do not exceed these two ratings:

- Maximum measurement voltage from the probe tip to the probe reference lead.
- Maximum floating voltage from the probe reference lead to earth ground.
- Set the correct attenuation factor on the instrument according to the probe being used. Otherwise, the measurement results do not reflect the actual voltage level, and you might misjudge the actual risk.
- Set up all connections to the instrument before applying power.
- Do not open the instrument casing.
- Do not use the instrument if the instrument casing, the display or any probe or accessory are damaged. If you detect or suspect any damage, have the instrument or accessory inspected by qualified service personnel.
- Do not operate the instrument in wet, damp or explosive atmospheres. Make sure that all connectors are completely dry before connecting the inputs.
- Observe the operating conditions specified in the data sheet and in the basic safety instructions.

Battery replacement

- Disconnect power supply, probes, test leads and all other cables before opening the battery cover.
- Use only the specified Li-ion battery pack, which is delivered with the instrument. You can order additional battery packs at Rohde & Schwarz, see data sheet for order number.
- Do not operate the instrument with the battery cover open.
- Use only the specified power adapter, which is delivered with the instrument.

Cleaning

Remove all probes, leads, USB and LAN cables and power supply before cleaning the instrument. Use only cleaning materials that are specified in the manual.

Measurement categories

IEC 61010-2-030 defines measurement categories that rate instruments on their ability to resist short transient overvoltages that occur in addition to the working voltage. Use the measurement instrument and accessories only in electrical environments for which they are rated.

- O - Instruments without rated measurement category
For measurements performed on circuits not directly connected to mains, for example, electronics, circuits powered by batteries, and specially protected secondary circuits. This measurement category is also known as CAT I.
- CAT II:
For measurements performed on circuits directly connected to the low-voltage installation by a standard socket outlet, for example, household appliances and portable tools.
- CAT III:
For measurements performed in the building installation, such as junction boxes, circuit breakers, distribution boards, and equipment with permanent connection to the fixed installation.
- CAT IV:
For measurements performed at the source of the low-voltage installation, such as electricity meters and primary overcurrent protection devices.

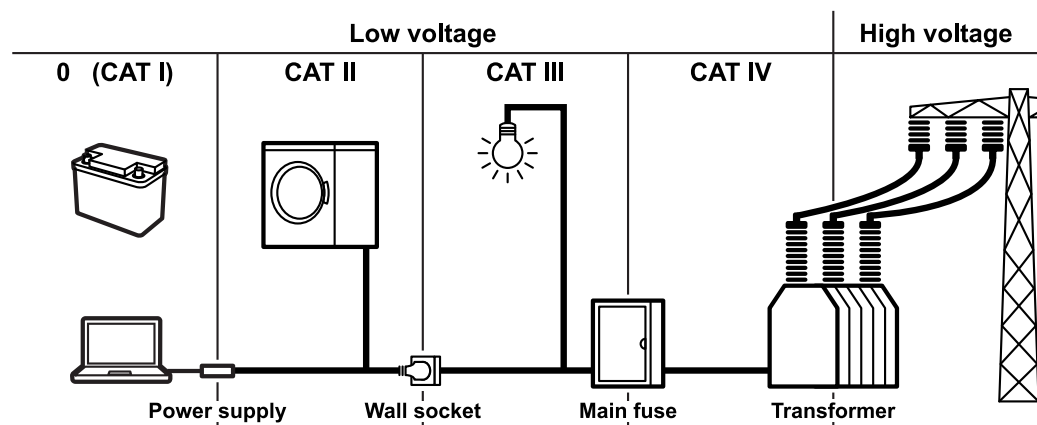

2 Getting Started

2.1 Preface

2.1.1 Key Features

The R&S RTH is the perfect multi-purpose tool for the lab and in the field. Outstanding key features are:

- Full isolation of all channels and interfaces
- CAT IV 600 V / CAT III 1000 V safety rating
- Bandwidth 60 MHz to 500 MHz with 5 GS/s sampling rate
- Acquisition speed up to 50.000 waveforms per second
- 2 mV/div sensitivity
- Up to 200 V offset range
- 33 automatic measurement functions
- Full operation using touch or keypad
- Wireless LAN and Ethernet for web based remote control and quick data access (optional)

The R&S RTH combines:

- Lab performance oscilloscope
- Logic analyzer with 8 digital inputs (optional)
- Protocol analyzer with trigger and decode (optional)
- Data logger
- Digital multimeter (R&S RTH1002)

2.1.2 Input Isolation

The instrument has independently floating isolated inputs. Each input channel has its own signal input and its own reference input. Each input channel is electrically isolated from the other input channels. Therefore, each reference of the used inputs must be connected to a reference voltage. Furthermore, input channels are electrically isolated from the communication ports and the power adapter input.

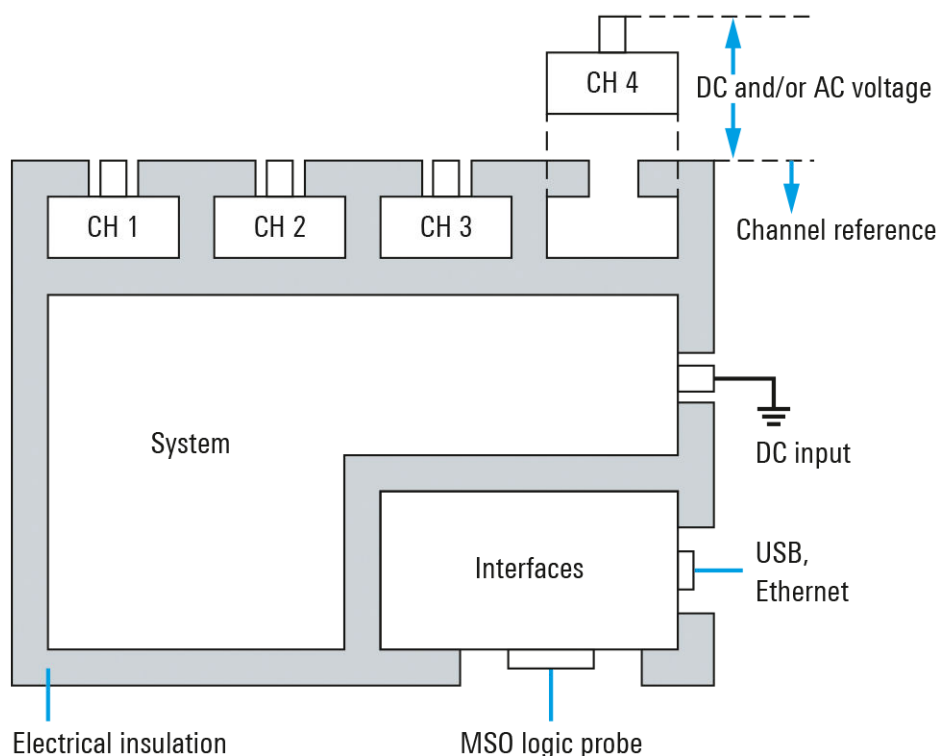

Figure 2-1: Isolation scheme of the R&S RTH

The input isolation has several advantages:

- You can measure independently floating signals simultaneously.
- The risk of causing a short circuit while measuring multiple signals is reduced substantially.
- When measuring signals with different grounds, the induced ground currents are kept to a minimum.

2.1.3 Documentation Overview

The user documentation for the R&S RTH consists of the following parts:

- **Instrument Help**
The instrument help is part of the instrument's firmware. It offers quick, context-sensitive access to the complete information directly on the instrument.
- **Basic Safety Instructions**
This brochure provides safety instructions and operating conditions and further important information. The brochure is delivered with the instrument in printed form.
- **Getting Started**
The Getting Started manual provides the information needed to set up and start working with the instrument, and describes basic operations. The English edition of this manual is delivered with the instrument in printed form. Editions in other languages and the newest version of the English manual are available on the product website.

- **User Manual**
The user manual describes all instrument modes and functions in detail. It also provides an introduction to remote control and a complete description of the remote control commands with programming examples. The newest version of the manual is available in English on the R&S RTH product website at www.rohde-schwarz.com/manual/rth.
- **Data Sheet**
The data sheet contains the complete instrument specification. It also lists the options and their order numbers, and optional accessories. The data sheet is available on the R&S RTH product website at www.rohde-schwarz.com/brochure-data-sheet/rth.
- **Calibration Certificate**
The document is available on <https://gloris.rohde-schwarz.com/calcert>.
- **Open Source Acknowledgment**
The Open Source Acknowledgment document provides verbatim license text of open source software that is used in the instrument's firmware. It is available on the R&S RTH website at www.rohde-schwarz.com/firmware/rth, and it can be read directly on the instrument.
- **Instrument security procedures manual**
Provides information on security issues when working with the R&S RTH in secure areas.
- **Application cards and application notes**
These documents deal with special applications or background information on particular topics. See www.rohde-schwarz.com/application/rth

2.2 Preparing for Use

This section describes the basic steps to be taken when setting up the R&S RTH for the first time.

⚠ WARNING**Shock hazard caused by high voltages**

The instrument must be used in an appropriate manner to prevent electric shock, fire, personal injury, or damage.

- Do not open the instrument casing.
- Do not use the instrument if the instrument casing, the display or any probe or accessory are damaged. If you detect or suspect any damage, have the instrument or accessory inspected by qualified service personnel.
- Use only specified probes and accessories that comply with the measurement category of your measurement task.
If you use other than Rohde & Schwarz accessories, make sure that they are suitable to the instrument and the measurement task.
- Do not operate the instrument in wet, damp or explosive atmospheres.
Make sure that all connectors are completely dry before connecting the inputs.
- Voltages higher than 30 V RMS or 42 V peak or 60 V DC are regarded as hazardous contact voltages. Make sure that only electrically skilled persons use the R&S RTH for measurements on hazardous contact voltages. These working conditions require special education and experience to perceive risks and to avoid hazards which electricity can create.
- Observe the operating conditions specified in the data sheet.
- Read and observe the "Safety Instructions" delivered as a printed brochure with the instrument. Also read and observe the safety instructions in the following sections.

2.2.1 Unpacking the Instrument

When you receive your shipping package, unpack and inspect the package and its contents for damage.

1. Inspect the package for damage.
If the packaging material shows any signs of stress, notify the carrier as well as your Rohde & Schwarz service center. Keep the package and cushioning material for inspection. Keep a damaged package and the cushioning material until the contents have been checked for completeness and the instrument has been tested.
2. Unpack the handheld scope and the accessories and check the contents for completeness, see "[Package contents](#)" on page 13.
If anything is missing, contact your Rohde & Schwarz service center.
3. Inspect the handheld scope and the accessories.
If there is any damage or defect, or if the R&S RTH does not operate properly, notify your Rohde & Schwarz service center.

**Packing material**

Retain the original packing material. If the instrument needs to be transported or shipped later, you can use the material to protect the control elements and connectors.

Package contents

The delivery package contains the following items:

- R&S RTH handheld oscilloscope
- 4 Gbyte microSD card, installed in the battery compartment
- Power adapter with cable and adapter set for various socket types
- Battery pack
- R&S RT-ZI10 probes (2x for R&S RTH1002; 4x for R&S RTH1004)
- DMM test leads (only for R&S RTH1002)
- Hand strap, attached on the handheld scope
- Printed "Getting Started" manual and "Basic Safety Instructions" brochure

Optional accessories and their order numbers are listed in the data sheet.

2.2.2 Inserting and Charging the Battery

Before you can use the handheld oscilloscope for the first time, insert the battery pack and charge it.

 WARNING**Risk of electrical shock during battery replacement**

- Disconnect power supply, probes, test leads and all other cables before opening the battery cover.
- Use only the specified Li-Ion battery pack, which is delivered with the instrument. You can order additional battery packs at Rohde & Schwarz, see Data Sheet for order number.
- Do not operate the instrument with the battery cover open.
- Use only the specified power adapter, which is delivered with the instrument.

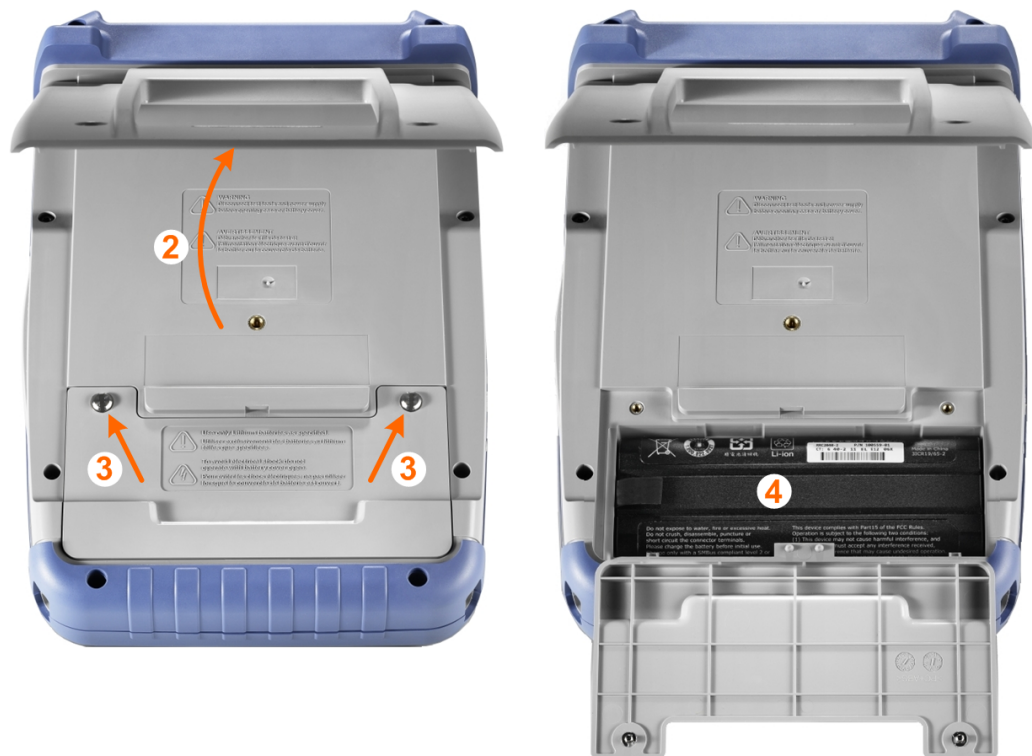

1. Turn off the instrument power. Remove power supply, probes, test leads and all other cables.
2. Fold out the tilt stand on the back of the instrument.
3. Screw open the battery cover.
4. Insert the battery pack.
5. Screw down the battery cover.
6. Connect the power adapter to the connector on the left side of the scope, and fully charge the battery. Charging may take a few hours.



If the instrument is on, the battery status is shown on the display.



Replace used batteries periodically by new batteries after 24 months of usage. Observe the safety regulations in the "Batteries and rechargeable batteries/cells" chapter in the "Basis Safety Instructions" brochure, which is delivered with the instrument.

2.2.3 Powering On/Off

- ▶ Press the  [Power] key to switch the instrument on or off. The key blinks and turns green after a few seconds.

Table 2-1: Colors of the Power key

Green	Power is on
Blue	Charging the battery, power is off
Orange (yellow)	Battery is fully charged, power adapter is connected, power is off

If you do not use the instrument for a longer time, the battery gets exhausted. When you connect the power supply and switch on the instrument with exhausted battery, it takes a few minutes until the instrument can start.

2.2.4 Using the Tilt Stand

The R&S RTH has a tilt stand for proper handling while the scope is placed on a table.

- ▶ Pull the tilt stand as shown below.



2.2.5 EMI Suppression

Electromagnetic Interference (EMI) may affect the measurement results.

To suppress generated Electromagnetic Interference:

- Use suitable shielded cables of high quality. For example use double-shielded RF and LAN cables.
- Always terminate open cable ends.
- Note the EMC classification in the data sheet.

2.3 Instrument Tour

2.3.1 Front View



Figure 2-2: Front panel of the R&S RTH1002

- 1 = Touch display
- 2 = Waveform setup with [AUTOSET], reset to default with [PRESET]
- 3 = Analysis functions
- 4 = Mode selection
- 5 = Save/Recall
- 6 = Instrument settings
- 7 = Power on/off
- 8 = Navigation controls
- 9 = Horizontal settings
- 10 = Run/stop acquisition and trigger settings
- 11 = Acquisition settings
- 12 = Screenshot and documentation output
- 13 = Channels and vertical settings
- 14 = Multimeter measurements

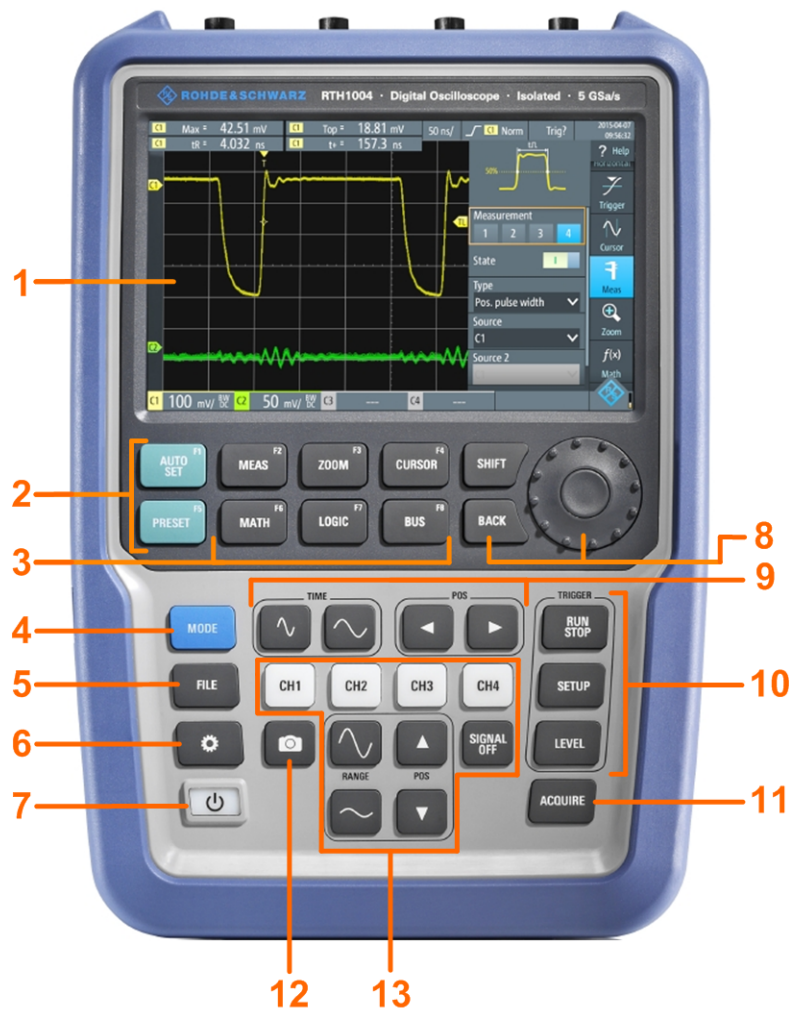

Figure 2-3: Front panel of the R&S RTH1004

- 1 = Touch display
- 2 = Waveform setup with [AUTOSET], reset to default with [PRESET]
- 3 = Analysis functions
- 4 = Mode selection
- 5 = Save/Recall
- 6 = Instrument settings
- 7 = Power on/off
- 8 = Navigation controls
- 9 = Horizontal settings
- 10 = Run/stop acquisition and trigger settings
- 11 = Acquisition settings
- 12 = Screenshot and documentation output
- 13 = Channels and vertical settings

For a description of the keys, see [Chapter 2.4.1.3, "Using Front Panel Keys"](#), on page 30.

2.3.2 Top View

The R&S RTH1002 has two BNC input connectors CH1 and CH2, and two 4 mm banana plug inputs for multimeter measurements. The channel inputs have double channel-to-channel isolation that allows for independent floating measurements at each input. The DMM input is fully isolated from scope inputs, interfaces, and ground.



Figure 2-4: Top view of R&S RTH1002

The R&S RTH1004 has four BNC input connectors CH1, CH2, CH3, CH4. The channel inputs have double channel-to-channel isolation that allows for independent floating measurements at each input.



Figure 2-5: Top view of R&S RTH1004

WARNING

Shock hazard caused by high voltages

To avoid electrical shock and personal injury, and to prevent damage to the instrument or any other products connected to it, observe the following:

- Do not apply input voltages above the rating of the instrument and the accessories.
- Use only probes, test leads, and adapters that comply with the measurement category (CAT) of your measurement task.
- Test leads and measurement accessories used for multimeter measurements on a live mains circuit must be rated for CAT III or CAT IV according to IEC 61010-031. The voltage of the measured circuit must not exceed the rated voltage value.

Maximum input voltage:

- At BNC inputs: CAT IV 300 V
- With probe R&S RT-ZI10 or R&S RT-ZI11: CAT IV 600 V, CAT III 1000 V
- Meter input: CAT IV 600 V; CAT III 1000 V

Voltage ratings: V RMS (50 to 60 Hz) for AC sine wave and V DC for DC applications.

⚠ WARNING**Risk of electrical shock or fire**

Voltages higher than 30 V RMS or 42 V peak or 60 V DC are regarded as hazardous contact voltages. When working with hazardous contact voltages, use appropriate protective avoid electrical shock and injuries:

- Use only insulated probes, cables, test leads and adapters.
- Do not touch voltages higher than 30 V RMS or 42 V peak or 60 V DC.

See also: [Chapter 2.1.2, "Input Isolation"](#), on page 9.

2.3.3 Right View

- 1 = LAN
- 2 = USB type B for remote control
- 3 = Probe compensation
- 4 = USB type A for flash drive
- 5 = Logic probe connector

⚠ CAUTION**Risk of injury or instrument damage**

Always close the lids of the communication ports and DC input when they are not in use.

LAN connector

RJ-45 connector to connect the instrument to a Local Area Network (LAN). It supports up to 100 Mbit/s.

USB type A connector

USB type A connector to connect a USB flash drive to store and reload instrument settings and measurement data.

USB type B connector (mini USB)

Mini USB connector to connect a computer for remote control of the instrument.

Probe compensation

Probe compensation terminal to support adjustment of passive probes to the oscilloscope channel.

Logic probe connector

Input for the logic probe R&S RT-ZL04. Logic analysis requires Mixed Signal Option R&S RTH-B1, which includes the logic probe R&S RT-ZL04.

⚠ WARNING**Risk of electrical shock - no CAT rating for MSO measurements**

The logic probe R&S RT-ZL04 is not rated for any measurement category. To avoid electrical shock or personal injury, and to prevent material damage, make sure that the ground clips of the R&S RT-ZL04 are connected to protective earth on the DUT.

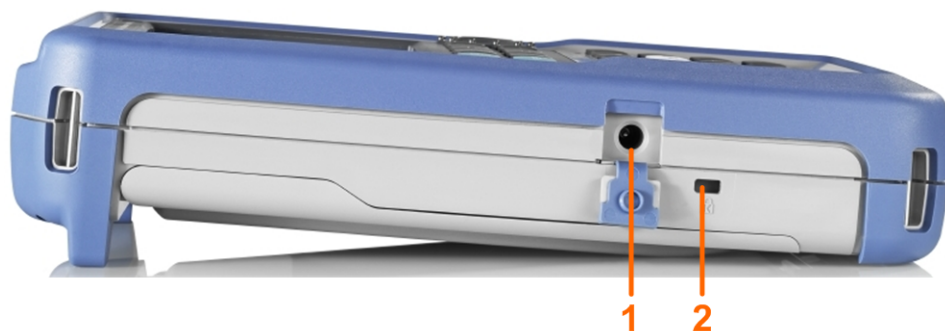
2.3.4 Left View

- 1 = DC input
- 2 = Kensington lock slot

DC input

Connector for the power adapter to charge the battery.

Kensington lock slot

The Kensington lock is used to secure the instrument against theft.

2.3.5 Rear View



- 1 = Tilt stand to fold out
- 2 = Thread hole M5
- 3 = Battery compartment

2.3.6 Display Overview

In the most important modes scope, mask and XY, the display shows the following information.

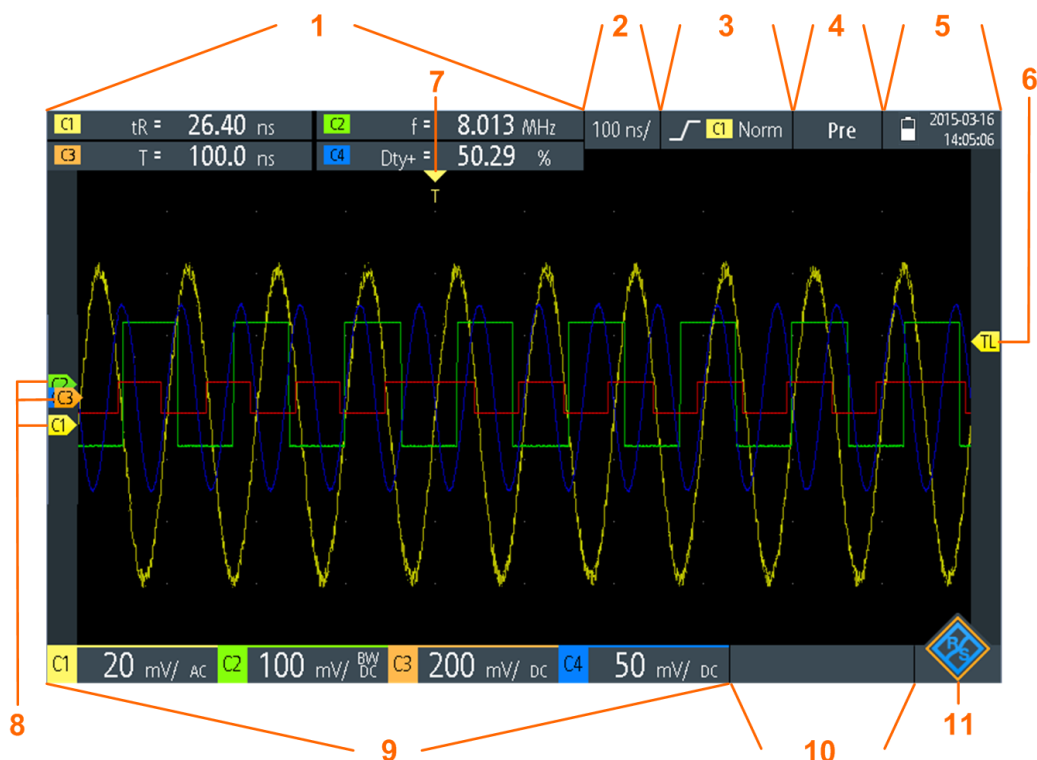

- 1 = Measurement results, depends on the mode and the selected measurement
- 2 = Time scale (horizontal scale, in s/division)
- 3 = Trigger type, trigger source, and trigger mode
- 4 = Capture status
- 5 = Battery status and AC connectivity for battery charging; date and time
- 6 = Trigger level marker, has the color of the trigger source
- 7 = Trigger position marker, has the color of the trigger source
- 8 = Channel markers indicate the ground levels. Channel C3 has the focus
- 9 = Vertical settings for each active channel: vertical scale (vertical sensitivity, in V/division), bandwidth limit (no indicator = full bandwidth, BW= limited frequency), coupling (AC or DC)
- 10 = Logic channels (MSO R&S RTH-B1)
- 11 = Menu button

You can adjust the vertical position of each waveform, the trigger level, and the trigger position by dragging the corresponding marker on the display. Alternatively, tap a marker to set the focus, and use the wheel to adjust position.

2.4 Operating Basics

2.4.1 Accessing the Functionality

The complete functionality is available in the menus and dialogs on the touchscreen. You can touch the functions directly on the display, or you can use the wheel to navi-

gate and select. In addition, the most important functions are applied to the keys on the front panel to set up and perform measurement tasks quickly.

2.4.1.1 Using the Touchscreen

Using the touchscreen of the R&S RTH is as easy as using your mobile phone. To open the menu, tap the "Menu" button - that is the R&S logo in the right bottom corner of the display.

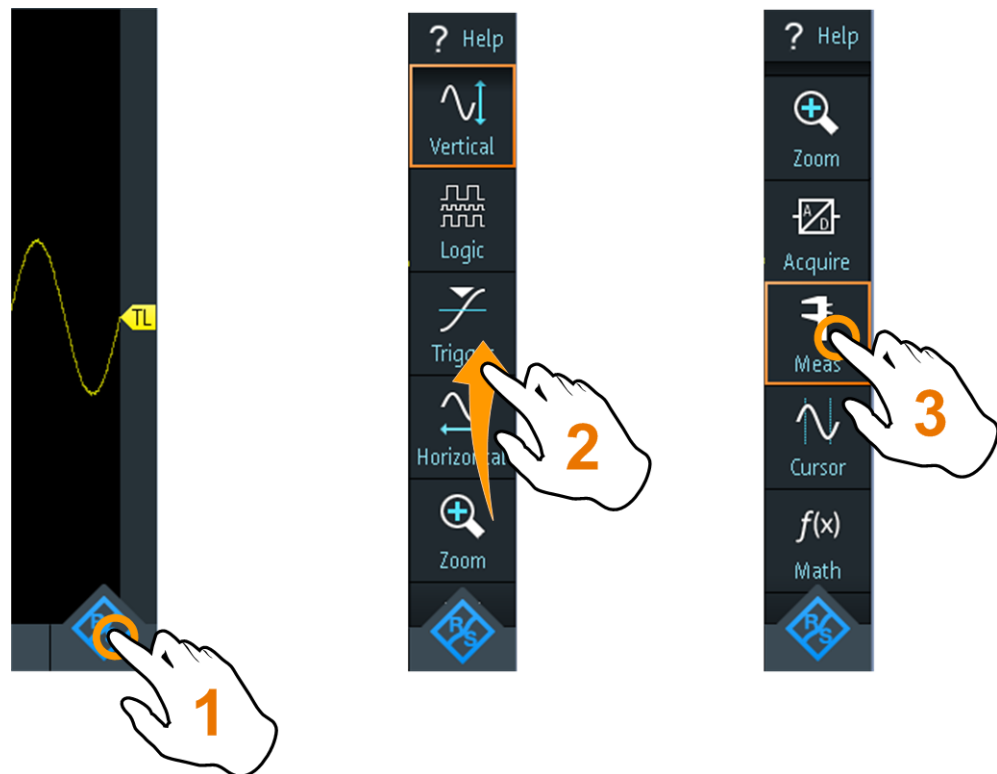

Figure 2-6: Open the menu and select a menu item



Figure 2-7: Switch on or off (left) and select a parameter value (right)

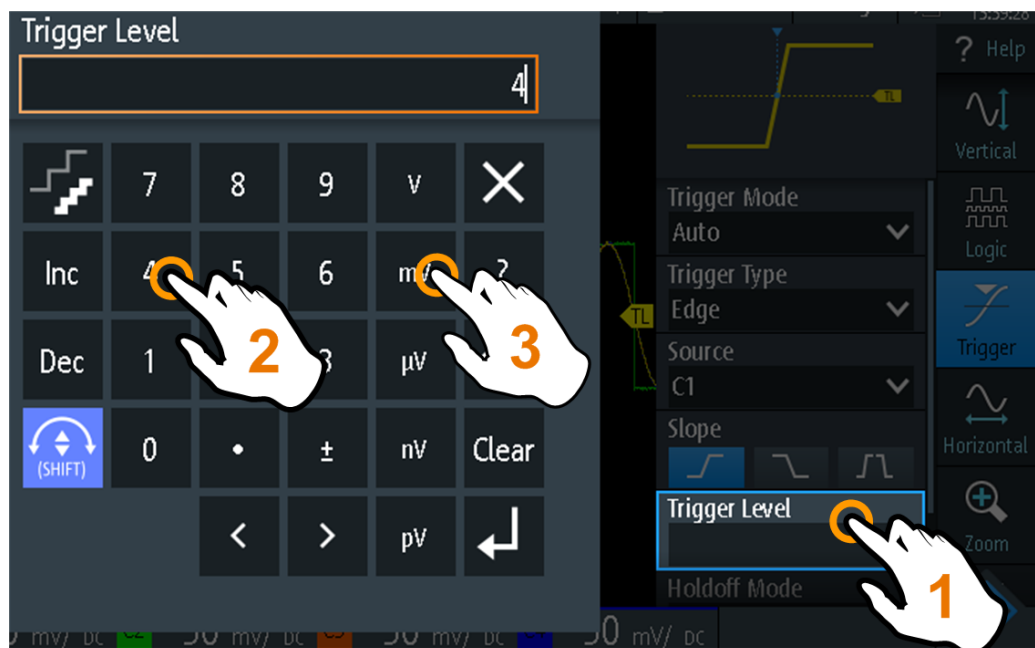

Figure 2-8: Enter numerical value and unit

2.4.1.2 Using the Navigation Wheel

In addition or alternatively to the touchscreen, you can use the wheel to control the R&S RTH.

When using the wheel, always observe the position of the focus - the orange frame or other highlighting that marks the active object on the screen.

- If the focus is on the menu button or somewhere in the menu or dialogs:
 - Turn the wheel to move the focus.
 - Press the wheel button to apply the selection.
- If the focus is on an element in the diagram, for example, on a waveform, cursor line, or trigger level:
 - Turn the wheel to change the position of the active element.
 - Press the wheel button to toggle the active element, for example, to toggle the cursor lines, or zoom size and zoom position.

The [BACK] key closes open dialogs and menus, and resets the focus to the "Menu" button.

Menu navigation

The following procedure describes how to access and navigate the menu. Navigating dialogs and selecting parameter values works in the same way. See also [Figure 2-9](#).

1. Press [BACK] until the focus is on the "Menu" button.
2. Press the wheel button to open the menu.
3. Turn the wheel to move the focus to the required menu item.
4. Press the wheel button to open the dialog, submenu, or keypad for the selected menu item.

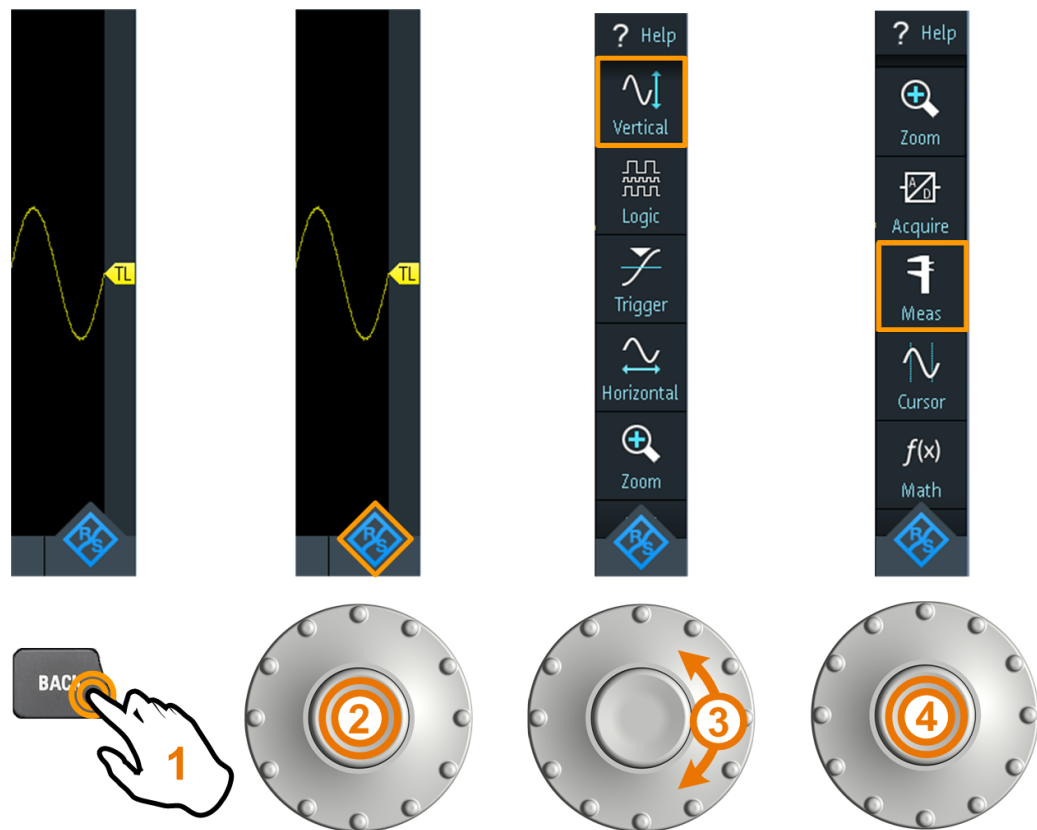

Figure 2-9: Open the menu and select a menu item

Set numerical value using the wheel

1. Set the focus to the required setting, and press the wheel button *once*.
2. Turn the wheel until the required value is shown.
3. Press [BACK].



Figure 2-10: Set numerical value using the wheel

Data entry using wheel and keypad

You can enter precise numerical values on the keypad. See also [Figure 2-11](#).

1. Set the focus to the required setting, and press the wheel button *twice*.
2. Turn the wheel until the focus is on the required number.
3. Press the wheel button.
4. Turn the wheel until the focus is on the required unit.
5. Press the wheel button.

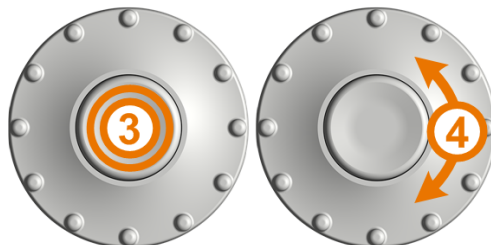
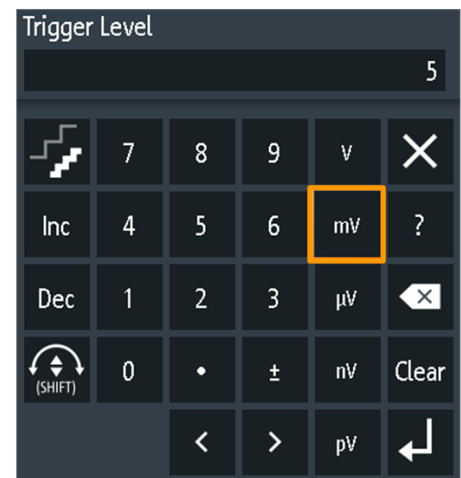
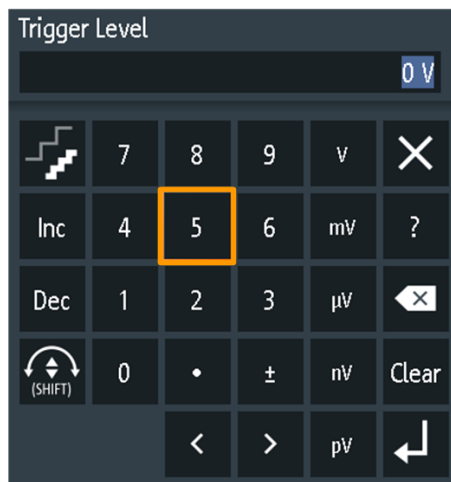
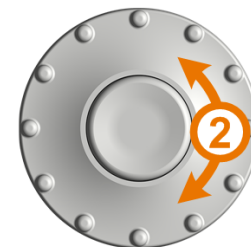
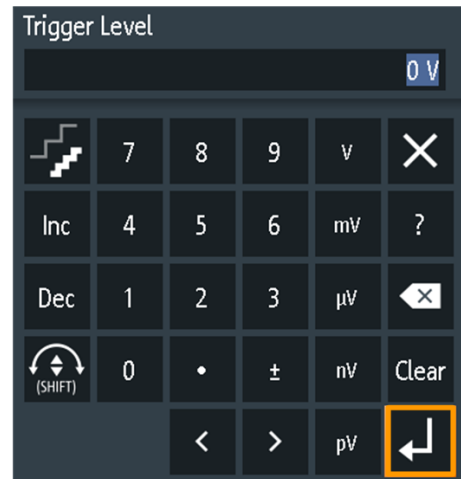





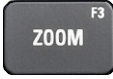

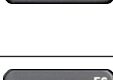
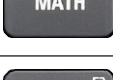



Figure 2-11: Enter numerical value and unit in the keypad











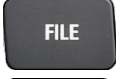



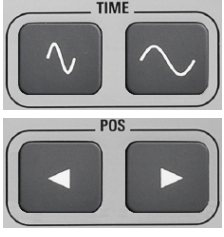

The [SHIFT] button toggles the wheel focus in the keypad. If the focus is on the entry field, turning the wheel changes the value. If the focus is in the lower part, the wheel selects numbers and unit.

2.4.1.3 Using Front Panel Keys

For an overview of the front panel keys, see [Figure 2-3](#)

Key	Press shortly	Press and hold
	[AUTOSET] analyses the active channels, adjusts the instrument settings, and displays stable waveforms.	
	[PRESET] sets the instrument to the default factory state.	
	[MEAS] starts or stops the last configured automatic measurements.	Opens or closes the "Meas" dialog to configure the measurements.
	[ZOOM] enables or disables the zoom with the last configuration. If the zoom is on but not in focus, pressing the key focuses the zoom.	Opens or closes the "Zoom" dialog to configure the zoom scale and position.
	[CURSOR] starts or stops the last configured cursor measurement. If the cursor is on but not in focus, pressing the key sets the focus to the first cursor line.	Opens or closes the "Cursor" dialog to configure the measurement.
	[MATH] switches the math waveform on or off.	Opens or closes the "Math" dialog to configure the math waveform.
	Requires logic analyzer option R&S RTH-B1 (MSO). The effect depends on the state of digital channels: If the all digital channels are off, the key switches them on and sets the focus. If the digital channels are on but not in focus, the key sets the focus. If the focus is on digital channels, the key switches them off.	Opens or closes the "Logic" dialog to configure digital channels.
	Activates or deactivates the serial bus. Requires at least one serial triggering and decoding option. Available options are listed in the data sheet.	Opens or closes the "Bus" dialog to configure serial protocols.
	[SHIFT] opens a dialog to save and load instrument settings.	Press and hold for 2 seconds to disable or enable the touch-screen.
	If a dialog or menu is open, [BACK] closes it. If the menu is closed, the key toggles the focus between focused element in the diagram and the Menu button.	

Key	Press shortly	Press and hold
  	Open or close the "Mode", "File" or "Setup" dialog, respectively.	
	Saves measurement documentation: Only screenshot if "one touch" is off. ZIP file with selected data if "one touch" is on.	Opens or closes the "Screenshot" dialog to configure the screenshot and the "one touch" output.
All R&S RTH:  Only R&S RTH1004: 	The effect depends on the channel state: If the channel is off, the key switches on the channel and sets the focus. The key lights up. If the channel is on but not in focus, the key sets the focus. The key lights up.	Open or close the "Vertical" dialog for the corresponding channel to configure the channel settings.
Only R&S RTH1002: 	[DMM] starts or stops the meter measurements (same as [MODE] = "Meter"). [DMM REL] enables or disables relative meter measurements.	Opens or closes the "Meter" dialog to configure the measurements.
	[TIME] and [POS] adjust the horizontal time scale and position of the trigger point.	
	[RANGE] and [POS] set the vertical scale (vertical sensitivity) and the vertical position of the focused waveform (analog or channel, math or reference waveform).	
	[SIGNAL OFF] switches off the focused waveform.	
	[RUN STOP] starts and stops the acquisition.	
	[SETUP] opens or closes the "Trigger" dialog to select the trigger type and adjust the trigger settings.	

Key	Press shortly	Press and hold
	[LEVEL] activates the trigger level to be set using the wheel. If the trigger type has two trigger levels, pressing the key toggles the upper and lower levels.	
	[ACQUIRE] opens or closes the "Acquire" dialog to adjust the acquisition mode.	
	[Power] key: switches the power on or off	

2.4.2 Selecting the Mode

A mode comprises all settings and functions that are needed to perform a measurement task. Selecting the mode is the first setup step.

1. Press the [MODE] key.

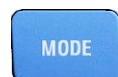

2. Select the mode:

- On the touchscreen: Tap the required mode icon.
- Using controls: Turn the wheel until the required mode is marked, and press the wheel button to select the mode.

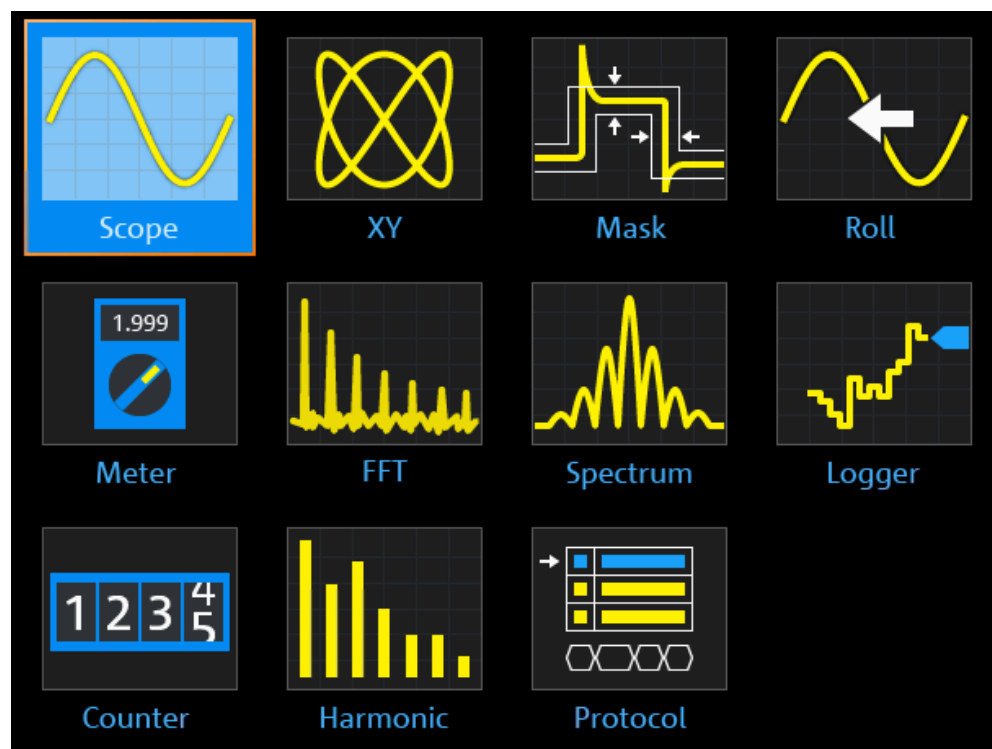

Remote command:

[OP \[:MODE\]](#) on page 303

2.4.3 Displaying an Unknown Signal

The R&S RTH can display unknown, complex signals automatically. The [AUTOSET] function analyzes the enabled channel signals, and adjusts the horizontal, vertical, and trigger settings to display stable waveforms.

1. Press the [PRESET] key.



[PRESET] sets the instrument to a default factory state. The previous user-defined configuration is removed and all channels except for channel 1 are disabled.

2. Press the [AUTOSET] key.

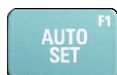

The waveform is displayed.

2.4.4 Getting Information and Help

In most dialogs, graphics explain the meaning of the selected setting. For further information, you can open the help, which provides functional description of the settings with links to the corresponding remote commands, and background information.

Note: When the help window is open, you can use only the [SHIFT] and [BACK] keys. Other keys may not work as expected. Close the help window before you use the keys.

2.4.4.1 Displaying Help

- ["To open the help window"](#) on page 33
- ["To show information on a setting"](#) on page 34
- ["To close the help window"](#) on page 35

To open the help window

- ▶ Tap the "Help" icon on the top of the menu.



If a dialog is open, the dialog's help topic is shown beside the dialog.
If a menu is open, the table of contents is shown.

To show information on a setting

If a dialog and the help window are open, you can easily call the information on each setting of the dialog.

- ▶ Tap the setting's *name*.

The corresponding help topic is displayed.

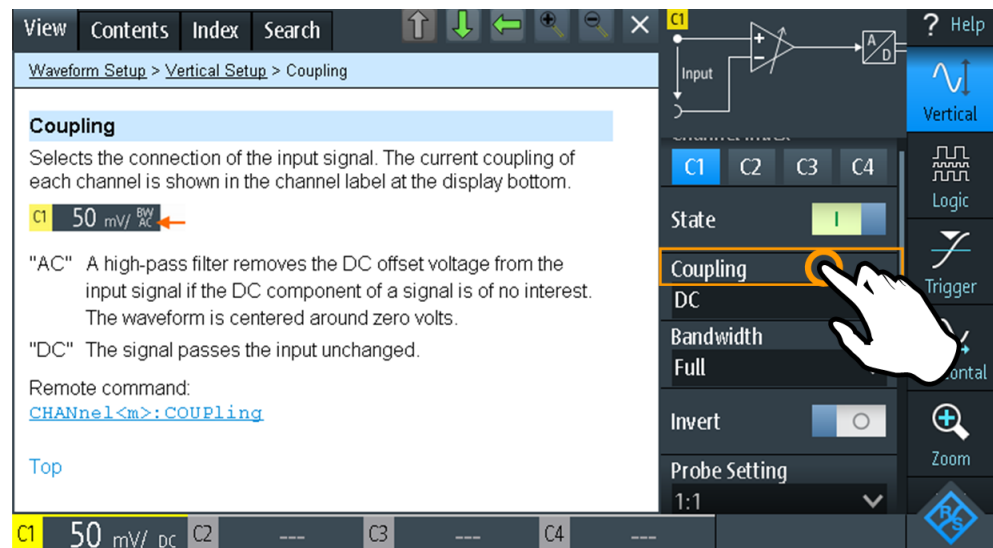

If you tap the *switch* or the *entry field*, you can adjust the setting without closing the help window.

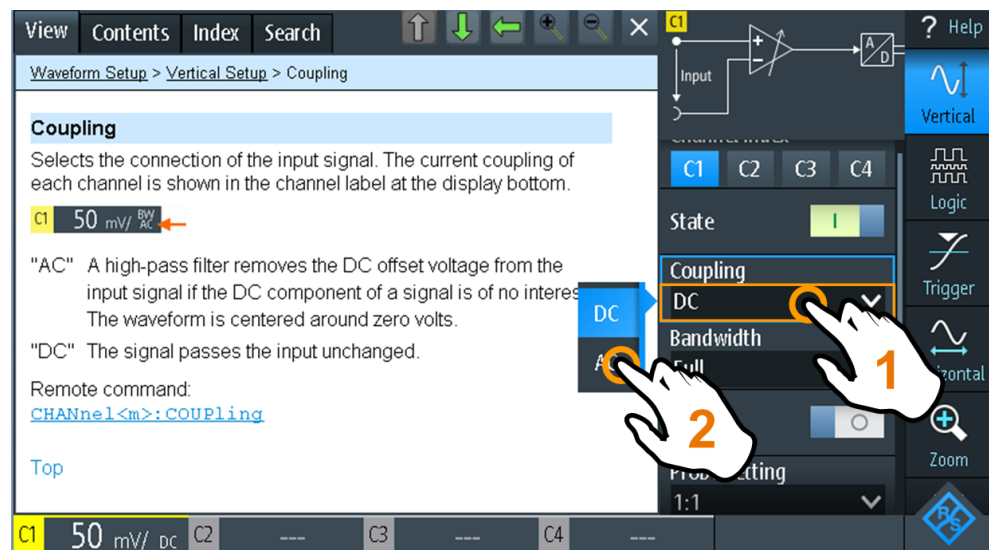

To close the help window

- ▶ Tap the "Close" icon in the upper right corner of the help window, or press [BACK].

2.4.4.2 Using the Help Window

The help window has several tabs:



- "View": shows the selected help topic.
- "Contents": contains a table of help contents.
- "Index": contains index entries to search for help topics.
- "Search": provides text search.

The help toolbar provides the following buttons:



- Up and down arrows: browse the topics in the order of the table of contents. Up = previous topic, down = next topic.
- Left and right arrows: browse the topics visited before: Left = back, right = forward.
- Magnifiers: increase or decrease the font.
- ×: closes the help window.

To search for a topic in the index

The index is sorted alphabetically. You can browse the list, or search for entries.

1. Tap the "Index" tab.
2. Tap the entry field on top of the list.

3. Enter some characters of the keyword you are interested in.
You can use the Backspace key to delete single characters, and "Clear" to delete all characters in the "Keyword" field.
4. Tap the Enter key.
Now only index entries are displayed that contain the keyword characters.
5. To delete the keyword:
 - a) Tap the entry field again.
 - b) Tap "Clear".
 - c) Tap the Enter key.

To search the help for a text string

1. Tap the "Search" tab.
2. Tap the entry field on the top.
3. Enter the words you want to find.
If you enter several words with blanks between, topics containing all words are found.
To find a string of several words, enclose it in quotation marks. For example, a search for *"trigger mode"* finds all topics with exactly *"trigger mode"*. A search for *trigger mode* finds all topics that contain the words *trigger* and *mode*.
4. Tap the Enter key.
A list of search results is displayed.
5. To refine the search, use "Match Whole Word" and "Match Case", and tap "Start Search".

2.5 Maintenance

The instrument does not need periodic maintenance. Only cleaning the instrument is essential.

The addresses of the Rohde & Schwarz support centers can be found at www.customersupport.rohde-schwarz.com.

A list of service centers is available on www.services.rohde-schwarz.com.

2.5.1 Cleaning

1. Remove all probes, leads, USB and LAN cables and power supply.
2. Clean the outside of the instrument using a soft, dry, lint-free dust cloth.

Note: Do not use any liquids for cleaning. Cleaning agents, solvents (thinners, acetone), acids and bases can damage the front panel labeling, plastic parts and display.

3. Clean the touchscreen as follows:
 - a) Apply a small amount of standard screen cleaner to a soft cloth.
 - b) Wipe the screen gently with the moist, but not wet, cloth.
 - c) If necessary, remove any excess moisture with a dry, soft cloth.

2.5.2 Contacting Customer Support

Technical support – where and when you need it

For quick, expert help with any Rohde & Schwarz equipment, contact one of our Customer Support Centers. A team of highly qualified engineers provides telephone support and works with you to find a solution to your query on any aspect of the operation, programming or applications of Rohde & Schwarz equipment.

Up-to-date information and upgrades

To keep your instrument up-to-date and to be informed about new application notes related to your instrument, please send an e-mail to the Customer Support Center stating your instrument and your wish. We will make sure that you get the right information.

Europe, Africa, Middle East

Phone +49 89 4129 12345

customersupport@rohde-schwarz.com

North America

Phone 1-888-TEST-RSA (1-888-837-8772)

customer.support@rsa.rohde-schwarz.com

Latin America

Phone +1-410-910-7988

customersupport.la@rohde-schwarz.com

Asia/Pacific

Phone +65 65 13 04 88

customersupport.asia@rohde-schwarz.com

China

Phone +86-800-810-8228 / +86-400-650-5896

customersupport.china@rohde-schwarz.com

2.5.3 Information for Technical Support

If you encounter problems that you cannot solve yourself, contact your Rohde & Schwarz support center, see [Chapter 2.5.2, "Contacting Customer Support"](#), on page 37. Our support center staff is optimally trained to assist you in solving problems.

The support center finds solutions more quickly and efficiently if you provide them with information on the instrument and an error description. To create, collect and save the required information, you can create a service report. It contains the bug report, all relevant setup information, reporting and log files, and the instrument configuration (device footprint).

1. Press , or open the "Setup" menu.
2. Scroll down.
3. Tap "Maintenance".
4. Select "Service".
5. Tap "Service Report".

The instrument creates the `.report` file and saves it to the USB flash device (if connected), or to the microSD card.

6. Attach the report file to an email in which you describe the problem. Send the email to the customer support address for your region as listed in the internet.

2.5.4 Data Storage and Security

The instrument is delivered with the 4 Gbyte microSD card inserted and ready to use. We recommend that you do not remove the microSD card.

All instrument configuration data and user data are stored on the microSD card. In addition, fallback firmware is stored on the microSD card to boot the instrument if an update failed.

If you use the instrument in a secured environment, you can remove the microSD card before the instrument leaves this area. The microSD card slot is under the right lid under the battery pack.

You can also change the microSD card if you need more memory. The instrument supports microSD cards up to 32 Gbyte.

2.5.5 Storing and Packing

The storage temperature range of the instrument is given in the data sheet. If the instrument is to be stored for a longer period of time, it must be protected against dust.

Repack the instrument as it was originally packed when transporting or shipping. The two protective foam plastic parts prevent the control elements and connectors from

being damaged. The antistatic packing foil avoids any undesired electrostatic charging to occur.

If you do not use the original packaging, use a sturdy cardboard box of suitable size and provide for sufficient padding to prevent the instrument from slipping inside the package. Wrap antistatic packing foil around the instrument to protect it from electrostatic charging.

3 Waveform Setup

3.1 Connecting Probes

WARNING

Shock hazard caused by high voltages

Make sure to set the attenuation factor on the instrument according to the probe being used. Otherwise, the measurement results do not reflect the actual voltage level, and you might misjudge the actual risk.

1. Connect the probe(s) to the channel input(s) at the top of the instrument.
2. To get the most accurate waveform display and best measurement results, remove all redundant connectors: power adapter, USB flash drive, DMM test leads and unused channels.
3. Press and hold the [CH] key of the used input.
4. Select "Probe Setting".
5. Select the attenuation factor of the probe:
 - To set a common attenuation factor, select it on the list.
 - To set a user-defined attenuation factor:
 - Select "User".
 - Set the "Probe Factor".

The probe's attenuation factor is indicated on the probe.

No attenuation with AC coupling:

If AC coupling is set, the attenuation of passive probes has no effect, and voltage is applied to the instrument with factor 1:1. Observe the voltage limits, otherwise you can damage the instrument.

Current measurements:

If you measure current using a shunt resistor as a current sensor, you have to multiply the V/A-value of the resistor by the attenuation of the probe. For example, if a 1 Ω resistor and a 10:1 probe is used, the V/A-value of the resistor is 1 V/A, the attenuation factor of the probe is 0.1, and the resulting current probe attenuation is 100 mV/A.

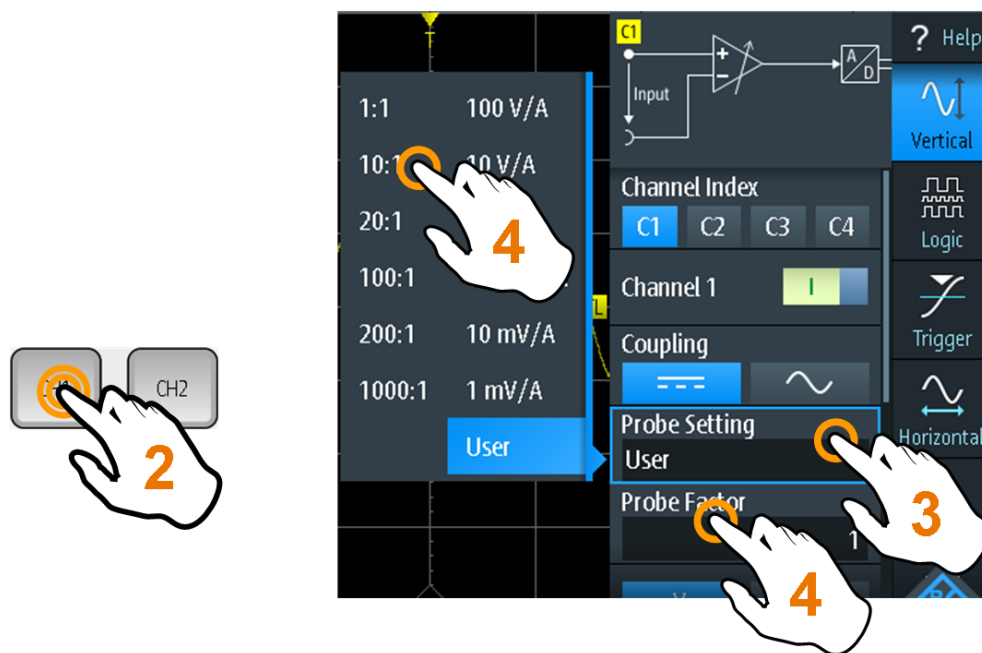

6. Switch off the test circuit.
7. Connect the probe to the DUT.
8. Switch on the test circuit.

3.2 Vertical Setup

The controls and parameters of the vertical system adjust the scale and position of the waveform vertically.



1. To set vertical scale and position, use the [RANGE] and [POS] keys.



2. To adjust other vertical settings, select "Vertical" in the main menu.

Vertical scale and vertical position affect the resolution of the waveform amplitude directly. To get the full resolution, make sure that the waveforms cover most of the screen's height.

3.2.1 Vertical Settings

As long as the "Vertical" menu is open, the probe settings of active channels are shown on top of the display.



Channel Index

Selects the channel to be configured. All settings in the channel menu belong to the selected channel.

You can also shortly press the channel key to select a channel. If you press and hold the channel key, the corresponding channel menu opens.

Channel <n>

Switches the selected channel on or off.

Remote command:

[CHANnel<m>:STATe](#) on page 304

Coupling

Selects the connection of the input signal. The current coupling of each channel is shown in the channel label at the display bottom.





AC coupling. A high-pass filter removes the DC offset voltage from the input signal if the DC component of a signal is of no interest. The waveform is centered on zero volts.

If AC coupling is set, the attenuation of passive probes has no effect, and voltage is applied to the instrument with factor 1:1. Observe the voltage limits, otherwise you can damage the instrument.



DC coupling, the signal passes the input unchanged.

Remote command:

[CHANnel<m>:COUPling](#) on page 307

Probe Setting

Selects the attenuation factor of the connected probe. The vertical scaling is adjusted accordingly, and measured values are multiplied by this factor so that the displayed values are equal to the actual signal values.

Make sure to set the attenuation factor on the instrument according to the probe being used. Otherwise, the measurement results do not reflect the actual voltage level, and you might misjudge the actual risk.

If AC coupling is set, the attenuation of passive probes has no effect, and voltage is applied to the instrument with factor 1:1. Observe the voltage limits, otherwise you can damage the instrument.

The menu lists the common attenuation factors. If the required factor is not in the list, select "User" and set the [Probe Factor](#).

Remote command:

[CHANnel<m>:PROBe](#) on page 305

Probe Factor

Sets a user-defined attenuation factor if the probe has an uncommon attenuation, and the unit (V or A). The setting is available if "Probe Setting" is set to "User".

Remote command:

[PROBe<m>:SETup:ATTenuation:MANual](#) on page 306

[PROBe<m>:SETup:ATTenuation:UNIT](#) on page 306

Bandwidth

Selects the bandwidth limit. The full instrument bandwidth indicates the range of frequencies that the instrument can acquire and display accurately with less than 3 dB attenuation.

For analog applications, the highest signal frequency determines the required oscilloscope bandwidth. The oscilloscope bandwidth should be at least 3 times higher than the maximum frequency included in the analog test signal to measure the amplitude with high accuracy.

Most test signals are more complex than a simple sine wave and include several spectral components. A digital signal, for example, is built up of several odd harmonics. For digital signals, the oscilloscope bandwidth should be at least 5 times higher than the clock frequency to be measured.

The oscilloscope is not an autonomous system. You need a probe to measure the signal, and the probe has a limited bandwidth, too. The combination of oscilloscope and probe creates a system bandwidth. To reduce the effect of the probe on the system bandwidth, the probe bandwidth should exceed the bandwidth of the oscilloscope, the recommended factor is 1.5 x oscilloscope bandwidth.

See also: [Chapter 3.2.2, "Effect of the Bandwidth Filter"](#), on page 46.

For FFT analysis, the channel bandwidth also determines the frequency range displayed in the spectrum (see ["Frequency range"](#) on page 111).

- "Full" At full bandwidth, all frequencies in the specified range are acquired and displayed. Full bandwidth is used for most applications.
- "x MHz, x kHz" Frequency limit. Frequencies above the selected limit are removed to reduce noise at different levels. Limited bandwidth is indicated in the channel label.



Remote command:

[CHANnel<m>:BANDwidth](#) on page 308

Invert

Turns the inversion of the signal amplitude on or off. To invert means to reflect the voltage values of all signal components against the horizontal display center. Inversion is indicated in the waveform labels by line above the channel name.

Inversion affects only the display of the signal but not the trigger. For example: if the oscilloscope triggers on the rising edge, the trigger is not changed by inversion, but the actually rising edge is displayed as falling edge.

Autoset does not reset inversion. In spectrum mode, the function also inverts the input channel signal, not the spectrum.

Remote command:

[CHANnel<m>:POLarity](#) on page 308

Offset

Sets an offset voltage that is subtracted to correct a signal with DC component. The vertical center of the selected channel is shifted by the offset value, and the signal is repositioned within the diagram area. Negative offset values move up the waveform, positive values move it down.

Remote command:

[CHANnel<m>:OFFSet](#) on page 307

Deskew

Sets a delay for the selected channel.

Deskew compensates delay differences between channels caused by the different length of cables, probes, and other sources. Correct deskew values are important for accurate triggering. The propagation delay can lead to a non-synchronous waveform display. For example, a signal on a coax cable with of 1 meter meter has a propagation delay of typically 5.3 ns.

Remote command:

[CHANnel<m>:DESKew](#) on page 308

Technology, Value

Sets the threshold, which is used to obtain the signal state. If the signal value is higher than the threshold, the signal state is high (1 or true for the Boolean logic). Otherwise, if the signal value is below the threshold, the signal state is considered low (0 or false). The threshold is used by the pattern and state trigger.

If a protocol option is installed, and the channel is used in the bus, the configured channel threshold is also used in the bus configuration. The values are the same in "Vertical" menu and bus configuration dialogs.

"Technology" Select a predefined value for one of the most common technologies, or select "User" to define an individual threshold.

"Value" Set an individual threshold value if "Technology" is set to "User".

Remote command:

[CHANnel<m>:THReshold:TECHnology](#) on page 309

[CHANnel<m>:THReshold:USER](#) on page 309

[CHANnel<m>:THReshold:THReshold?](#) on page 309

[CHANnel<m>:THReshold:FINDlevel](#) on page 310

[RANGE] keys

The vertical [RANGE] keys set the vertical scale (vertical sensitivity) of the selected waveform.

In FFT mode, the [RANGE] keys set the scale for the amplitude range (y-axis) in the spectrum display.

In "Counter" mode, the [RANGE] keys set the measurement range.

Remote command:

[CHANnel<m>:SCALE](#) on page 305

[CHANnel<m>:RANGe](#) on page 305

FFT mode:

[SPECTrum:FREQuency:MAGNitude:SCALE](#) on page 358

Spectrum mode:

[SPECTrum:FREQuency:SCALE](#) on page 363

Counter mode:

[COUNter<m>:SENSe:RANGe](#) on page 416

[POS] keys

Move the selected signal up or down in the diagram. The position is a graphical setting given in divisions, while the offset sets a voltage.

You can also drag the channel marker on the screen.

Remote command:

[CHANnel<m>:POSition](#) on page 307

Spectrum mode:

[SPECTrum:FREQuency:POSition](#) on page 363

3.2.2 Effect of the Bandwidth Filter

Low-pass filters reduce the speed of the signal inside the instrument and cause a delay of the signal on the screen. The delay time depends on the selected filter.

The following table lists the approximate delay of the signal that is caused by various filters.

Table 3-1: Approximate signal delay dependent on the bandwidth filter

Filter	Approx. delay	Filter	Approx. delay
200 MHz	30.2 ns	500 kHz	9.07 μ s
100 MHz	30.7 ns	200 kHz	22.13 μ s
50 MHz	138.5 ns	100 kHz	43.87 μ s
20 MHz	145 ns	50 kHz	87.47 μ s
10 MHz	166.5 ns	20 kHz	218 μ s
5 MHz	193 ns	10 kHz	434.7 μ s
2 MHz	270.5 ns	5 kHz	869.3 μ s
1 MHz	4.71 μ s	2 kHz	2.173 ms
		1 kHz	4.347 ms

3.3 Horizontal Setup

Horizontal settings, also known as timebase settings, adjust the display in horizontal direction.



1. To set the timebase and horizontal position, use the [TIME] and [POS] keys.



2. To adjust all horizontal settings, select "Horizontal" in the main menu.

The determining point of an acquisition is the trigger point. Two parameters define the position of the trigger point: reference point and horizontal position (also known as trigger offset or delay). Using these parameters, you choose the part of the waveform you want to see: around the trigger, before, or after the trigger.

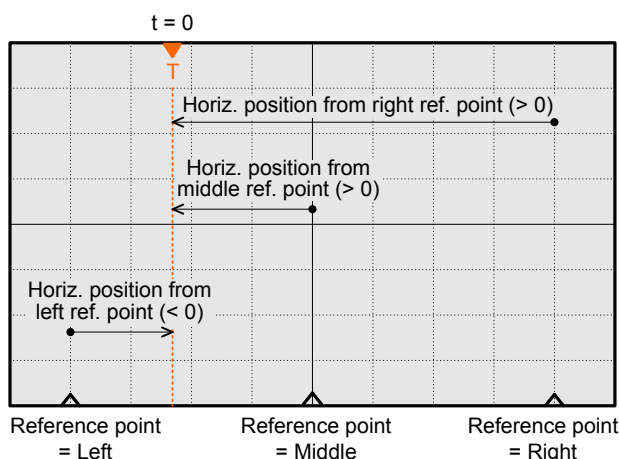

Signal delay

If you have set a bandwidth limit, the signal might appear delayed on the screen. The delay time depends on the selected filter. The effect is visible if several signals with different limits are displayed.

See also: [Chapter 3.2.2, "Effect of the Bandwidth Filter"](#), on page 46.



Description of settings

Time scale	100 ns/div	▼
Horizontal position	400 ns	
Reference point	Middle	▼

Time Scale

Sets the time scale (timebase) of the horizontal axis for all signals, in seconds per division. The value is shown in the top information bar.

Increase the scale to see a longer part of the waveform. Decrease the scale to see the signal in more detail. The scale has a point that remains fixed on the screen when the scale value is changing - the reference point.

To set the time scale, you can also use the [TIME] keys.

Note: In FFT mode, the time scale may be restricted depending on the selected frequency span, (see "[Frequency Span](#)" on page 114).

Remote command:

[TIMEbase:SCALE](#) on page 310

[TIMEbase:RANGE](#) on page 310

Horizontal Position

Sets the horizontal position of the trigger point in relation to the reference point. The trigger position is marked by a colored triangle at the top of the diagram.

You can set the trigger point even outside the diagram and analyze the signal some time before or after the trigger. In this case, the trigger marker is shown on the left or right side of the diagram.

To set the horizontal position, you can also use the [POS] keys.

Remote command:

[TIMebase:HORizontal:POSition](#) on page 310

Reference Point

Defines the time reference point in the diagram. You can set the reference point in the middle, or to the right to see the signal before the trigger. If the reference point is on the left, you see the signal after the trigger.

Remote command:

[TIMebase:REFerence](#) on page 311

3.4 Acquisition Control

Acquisition settings define the processing of the captured samples in the instrument.



- ▶ To adjust the acquisition settings, press the [ACQUIRE] key, or select "Acquire" in the main menu.

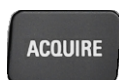

- ▶ To start or stop acquisition, press the [RUN STOP] key.

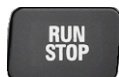

The R&S RTH captures the input signal and converts it to digital samples. The digital samples are processed according to the acquisition settings. The result is a waveform record that is displayed on the screen and stored in memory.

Description of settings



Figure 3-1: Acquire menu of R&S RTH1002 (without mixed signal option R&S RTH-B1)

Acquisition Mode

Defines how the waveform is built from the captured samples. There are two general methods to build the waveform record: sample decimation and waveform arithmetic.

Sample decimation reduces the data stream of the ADC to a stream of waveform points with lower sample rate and a less precise time resolution. The R&S RTH uses decimation, if the waveform "Sampling Rate C1 - C4" is less than the ADC sample rate. The acquisition modes "Sample", "Peak Detect" and "High Resolution" are decimation methods.

Waveform arithmetic builds the resulting waveform from several consecutive acquisitions of the signal. The acquisition modes "Average" and "Envelope" are arithmetic methods.

"Sample"	One of n samples in a sample interval is recorded as waveform point, the other samples are discarded. Usually, most signals are displayed optimally with this acquisition mode but very short glitches might remain undiscovered by this method.
"Peak Detect"	The minimum and the maximum of n samples are recorded as waveform points, the other samples are discarded. Thus the instrument can detect fast signal peaks at slow time scale settings that would be missed with other acquisition modes.
"High Resolution"	The average of n captured sample points is recorded as one waveform point. Averaging reduces the noise, the result is a more precise waveform with higher vertical resolution.

"Average" The average is calculated from the data of the current acquisition and several acquisitions before. The method reduces random noise. It requires a stable, triggered and periodic signal. The number of acquisitions for average calculation is defined with [Number of Averages](#).

"Envelope" The minimum and maximum values in a sample interval over several acquisitions are saved. The most extreme values of all acquisitions build the envelope. The resulting diagram shows two envelope waveforms: the minimums (floor) and maximums (roof) representing the borders in which the signal occurs.

Remote command:

[ACQUIRE:MODE](#) on page 312

Number of Averages

Sets the number of waveforms used to calculate the average waveform.

Remote command:

[ACQUIRE:AVERAGE:COUNT](#) on page 312

Reset Waveform

Restarts the envelope and average calculation.

Remote command:

[ACQUIRE:ARESET:IMMEDIATE](#) on page 312

Sampling Rate C1 - C4

Shows the number of recorded analog waveform points per second. The sample rate is the reciprocal value of the resolution.

Sampling Rate D7 - D0

Shows the number of recorded digital waveform points per second. Only available if the mixed signal option R&S RTH-B1 is installed, and logic channels are active.

Preselected Record Len.

Sets the record length.

"Max" Sets the maximum record length.

"Middle" Limits the record length to 12.5 ksample.

"Min" Limits the record length to 1.25 ksample.

Remote command:

[ACQUIRE:POINTS:PRESELECT](#) on page 312

Act. Record Len. C1 - C4

Shows the actual record length of analog channels. The actual value can be lower than the value set with "[Preselected Record Len.](#)" on page 50, depending on various conditions:

- Number of active channels
- "Acquisition Mode" is "Peak Detect" or "High Resolution"
- If the history option R&S RTH-K15 is installed: "Number of Segments". A high "Number of Segments" can restrict the record length.

- In roll mode, if analog and digital channels are active: the minimum record length of analog channels or digital channels is used.
- At slow timebases: see [Waveform Update](#).

If the "Time Scale" is set to 100 s/div or higher, the actual record length can be higher than the value set with "[Preselected Record Len.](#)" on page 50.

Act. Record Len. D7 - D0

Shows the actual record length of digital channels. Only available if the mixed signal option R&S RTH-B1 is installed, and logic channels are active.

Waveform Update

The setting is relevant if the time scale is ≥ 50 ms/div. At these slow timebases, you can select how the acquired samples are displayed.

- | | |
|--------------------------|--|
| "Intermediate" | The acquired samples are displayed before the acquisition is completed. In this mode, the record length is limited to 125 ksample. |
| "After full acquisition" | The acquired samples are displayed when the complete acquisition has been recorded. Depending on the selected time scale, it takes some time until the waveform is visible. This mode does not limit the record length and is always used for time scales < 50 ms/div. |

Remote command:

[ACQUIRE:WAVEformupd](#) on page 313

Acquisitions per Second

Shows the number of acquired waveforms per second.

[RUN STOP] key

Starts and stops the acquisition.

Remote command:

[RUN](#) on page 311

[STOP](#) on page 311

3.5 Roll Mode

The roll mode moves the captured input data on the display from the right to the left. The instrument shows the waveform immediately, without waiting for the complete acquisition of the waveform record. The roll mode displays the untriggered signal. Use the roll mode for slow, non-repetitive signals.

In roll mode, the following acquisition modes are available: sample, high resolution, and peak detect.



To activate the roll mode:

1. Press the [MODE] key.
2. Select "Roll".

To analyze the signal in roll mode, you can use:

- Zoom
- Automatic measurements
- Cursor measurements
- Mathematics

You can also save the waveform data. Saving stops the acquisition. Acquisition is resumed when the data is written.

3.6 Trigger

Triggering means to capture the interesting part of the relevant waveforms. Choosing the right trigger type and configuring all trigger settings correctly allows you to detect various incidents in signals.

A trigger occurs if the trigger conditions are fulfilled. The instrument acquires continuously and keeps the sample points to fill the pretrigger part of the waveform record. When the trigger occurs, the instrument continues acquisition until the posttrigger part of the waveform record is filled. Then it stops acquiring and displays the waveform. When a trigger is recognized, the instrument does not accept another trigger until the acquisition is complete.

Trigger conditions include:

- Source of the trigger signal (channel)
- Trigger type and its setup, including one or more trigger levels
- Trigger mode

In addition, the horizontal position of the trigger point and the reference point are important to display the interesting part of the signal. See [Chapter 3.3, "Horizontal Setup"](#), on page 46.

The trigger level and position are marked in the grid. The markers have the color of the trigger source. Information on the most important trigger settings is shown in the upper information bar.



Figure 3-2: Trigger information: width trigger on channel 2, single trigger mode



- ▶ To adjust all trigger settings, press the [SETUP] key.
- ▶ To adjust the trigger level, do one of the following:
 - Drag the trigger level marker on the right side of the display to the required position.
 - Press the [LEVEL] key and turn the wheel.
If the trigger type has two trigger levels, press the [LEVEL] key again to toggle the upper and lower levels. Alternatively, press the wheel.
 - Press the [SETUP] key. Select "Trigger Level", and enter the level value.

- ▶ To start and stop acquisition, press the [RUN STOP] key.

3.6.1 General Trigger Settings

General trigger settings are the settings that are independent of the trigger type. The settings specific for a trigger type are described in the following sections.

Description of settings



Trigger Mode

The trigger mode determines the behavior of the instrument if no trigger occurs, and also the number of acquired waveforms when a trigger occurs.

- | | |
|----------|--|
| "Auto" | The instrument triggers repeatedly after a time interval if the trigger conditions are not fulfilled. If a real trigger occurs, it takes precedence. This mode helps to see the waveform even before the trigger is set. Successive waveforms are not triggered at the same point of the waveform. |
| "Normal" | The instrument acquires waveforms continuously, each time when a trigger occurs. If no trigger occurs, no waveform is acquired and the last acquired waveform is displayed. If no waveform was captured before, nothing is displayed. |
| "Single" | When a trigger occurs, the instrument acquires one waveform and stops the acquisition. |

Remote command:

[TRIGger:MODE](#) on page 315

Trigger Type

Selects the trigger type, the event type that defines the trigger point.

- [Chapter 3.6.2, "Edge Trigger"](#), on page 55
- [Chapter 3.6.3, "Glitch Trigger"](#), on page 56
- [Chapter 3.6.4, "Width Trigger"](#), on page 57

- [Chapter 3.6.5, "Video/TV Trigger"](#), on page 59

R&S RTH-K19 trigger options

- [Chapter 3.6.7, "Pattern Trigger \(R&S RTH-K19\)"](#), on page 64
- [Chapter 3.6.8, "State Trigger \(R&S RTH-K19\)"](#), on page 66
- [Chapter 3.6.9, "Runt Trigger \(R&S RTH-K19\)"](#), on page 67
- [Chapter 3.6.10, "Slew Rate Trigger \(R&S RTH-K19\)"](#), on page 69
- [Chapter 3.6.11, "Data2Clock Trigger \(R&S RTH-K19\)"](#), on page 70
- [Chapter 3.6.12, "Serial Pattern Trigger \(R&S RTH-K19\)"](#), on page 72
- [Chapter 3.6.13, "Timeout Trigger \(R&S RTH-K19\)"](#), on page 75
- [Chapter 3.6.14, "Interval Trigger \(R&S RTH-K19\)"](#), on page 76
- [Chapter 3.6.15, "Window Trigger \(R&S RTH-K19\)"](#), on page 77

Options containing special triggers

- [Chapter 3.6.16, "Protocol Trigger \(R&S RTH-K1, -K2, -K3, -K9 and -K10\)"](#), on page 78

Remote command:

[TRIGger:TYPE](#) on page 315

Source

Selects the trigger source, the channel on which the trigger condition is checked. All possible channels are listed. You can trigger on any channel to which a signal is connected, even if the channel is not active.

For most trigger types, analog and digital channels can be used as trigger source. Digital channels require option R&S RTH-B1. For video, runt and slew rate trigger, only analog channels are available.

Remote command:

[TRIGger:SOURce](#) on page 315

Trigger Level

Sets the trigger voltage level.

For the Video/TV trigger, the trigger level is the threshold of the sync pulse. Make sure that the trigger level crosses the synchronizing pulses of the video signal.

Remote command:

[TRIGger:LEVel<m>:VALue](#) on page 316

Holdoff Mode

Selects the method to define the holdoff.

The trigger holdoff defines when the next trigger after the current will be recognized. Thus, it affects the next trigger to occur after the current one. Holdoff helps to obtain stable triggering when the oscilloscope is triggering on undesired events.



"Off"	No holdoff
"Time"	Defines the holdoff as a time period. The next trigger occurs only after the "Time" on page 55 has passed.
"Events"	Defines the holdoff as a number of trigger events. The next trigger only occurs when this number of events is reached. The number of triggers to be skipped is defined in "Events" on page 55.
"Random"	Defines the holdoff as a random time limited by "Min Time / Max Time" on page 55. For each acquisition, the instrument selects a new random holdoff time from the specified range. Random holdoff prevents synchronization to discover effects invisible with synchronized triggering, e.g. the features of a pulse train.

Remote command:

`TRIGger:HOLDoff:MODE` on page 316

Time ← Holdoff Mode

Sets the time that has to pass at least until the next trigger occurs.

Remote command:

`TRIGger:HOLDoff:TIME` on page 316

Events ← Holdoff Mode

Sets the number of triggers to be skipped until the next trigger occurs.

Remote command:

`TRIGger:HOLDoff:EVENTs` on page 317

Min Time / Max Time ← Holdoff Mode

Set the time limits for random holdoff time. For each acquisition, the instrument selects a new random holdoff time from the specified range.

Remote command:

`TRIGger:HOLDoff:MIN` on page 317

`TRIGger:HOLDoff:MAX` on page 317

Noise Reject

Enables a hysteresis to avoid unwanted trigger events caused by noise oscillation around the trigger level.

Remote command:

`TRIGger:MNR` on page 317

3.6.2 Edge Trigger

The edge trigger is the most common trigger type. The trigger occurs when the signal from the trigger source passes the trigger level in the specified direction (slope).

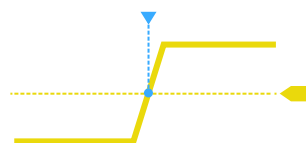

☰ Description of settings

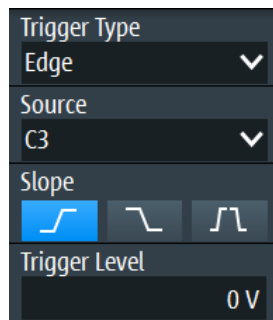





Figure 3-3: Edge trigger

Slope

Sets the edge direction for the trigger. You can trigger on:

-  rising edge, that is a positive voltage change
-  falling edge, that is a negative voltage change
-  rising and falling edge

Remote command:

[TRIGger:EDGE:SLOPe](#) on page 317

3.6.3 Glitch Trigger

The glitch trigger detects pulses shorter or longer than a specified time. It identifies deviation from the nominal data rate and helps to analyze causes of even rare glitches and their effects on other signals.

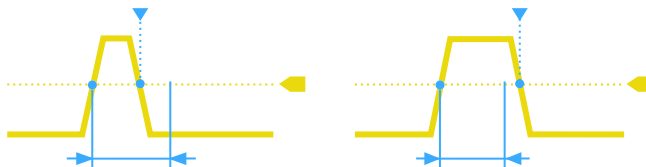

Description of settings

Trigger Type	Glitch
Source	C3
Polarity	<input checked="" type="radio"/>  <input type="radio"/>  <input type="radio"/> 
Range	Shorter
Width	4.8 ns
Trigger Level	0 V

Polarity

Sets the pulse polarity, that is the direction of the first pulse slope. You can trigger on:

- Positive going pulses. The width is defined from the rising to the falling edge.
- Negative going pulses. The width is defined from the falling to the rising edge.
- Both positive and negative going pulses

Remote command:

[TRIGger:GLITch:POLarity](#) on page 318

Range

Selects the glitches to be identified: shorter or longer than the specified "[Width](#)" on page 57.

Remote command:

[TRIGger:GLITch:RANGe](#) on page 318

Width

Sets the pulse width of the glitch.

Remote command:

[TRIGger:GLITch:WIDTh](#) on page 318

3.6.4 Width Trigger

The width trigger compares the measured pulse width (duration of a pulse) with a given time limit. It detects pulses with an exact pulse width, pulses shorter or longer than a given time, as well as pulses inside or outside the allowable time range. The pulse width is measured at the trigger level.

Using the width trigger, you can define the pulse width more precisely than with the glitch trigger. However, using the range settings "Shorter" and "Longer", you can also trigger on glitches.

☰ Description of settings



Figure 3-4: Width trigger

Polarity

Sets the pulse polarity, that is the direction of the first pulse slope. You can trigger on:

- Positive going pulses. The width is defined from the rising to the falling edge.
- Negative going pulses. The width is defined from the falling to the rising edge.
- Both positive and negative going pulses

Remote command:

`TRIGger:WIDTH:POLarity` on page 319

Range

Defines how the measured pulse width is compared with the given limits.

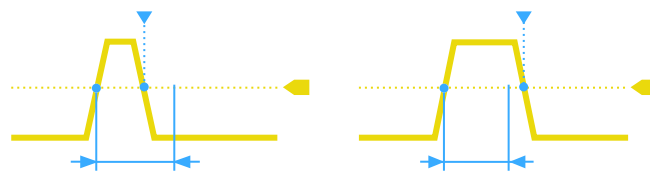

Figure 3-5: Pulse width is shorter or longer than a given width (same as glitch trigger)

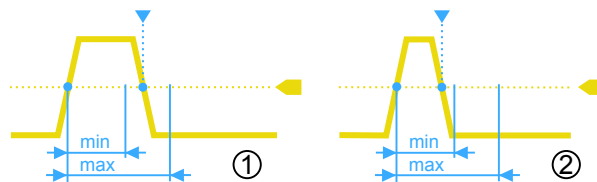

Figure 3-6: Pulse width is inside or outside a range

- 1 = Inside, pulse > min width AND pulse < max width
 2 = Outside, pulse < min width OR pulse > max width

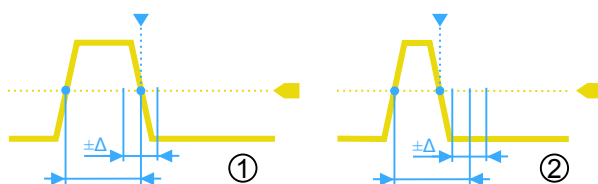

Figure 3-7: Pulse width is equal or unequal to a given width, with optional tolerance

- 1 = Equal, pulse > width - Δ AND pulse < width + Δ
 2 = Unequal, pulse < width - Δ OR pulse > width + Δ

Remote command:

[TRIGger:WIDTH:RANGE](#) on page 319

Width

Sets the width for comparisons equal, unequal, shorter, and longer.

Remote command:

[TRIGger:WIDTH:WIDTH](#) on page 319

\pm Tolerance

Sets a range Δt to the specified [Width](#) if the comparison range is equal or unequal. To trigger on an exact pulse width, set the tolerance to 0.

Remote command:

[TRIGger:WIDTH:DELTA](#) on page 319

Min Width / Max Width

Set the lower and upper time limits defining the time range if "Inside" or "Outside" is set for comparison.

Remote command:

[TRIGger:WIDTH:MIN](#) on page 320

[TRIGger:WIDTH:MAX](#) on page 320

3.6.5 Video/TV Trigger

The TV or video trigger is used to analyze analog baseband video signals. You can trigger on baseband video signals from standard definition and high definition standards, and also on user defined signals.

The instrument triggers on the line start - the horizontal sync pulse. You can trigger on all lines, or specify a line number. You can also trigger on the field or frame start.

3.6.5.1 Standard TV Trigger Settings

Access: [SETUP] key > "Trigger Type" = "Video/TV"

Trigger Type	Video/TV	▼
Source	C3	▼
Standard	PAL	▼
Signal Polarity	Positive	▼
Mode	All Fields	▼
Trigger Level	0 V	

Standard

Selects the TV standard or "Custom" for user-defined signals.

The standards PAL, PAL-M, NTSC and SECAM are available in the instrument firmware. All other standards require the advance trigger option R&S RTH-K19.

HDTV standards are indicated by the number of active lines, the scanning system (p for progressive scanning, i for interlaced scanning) and the frame rate. For interlaced scanning, the field rate is used instead of the frame rate. 1080p/24sF is an HDTV standard using progressive segmented frame scanning.

"Custom" can be used for signals of other video systems, for example, medical displays, video monitors, and security cameras. To trigger on these signals, you have to define the pulse type and length of the sync pulse, the scanning system and the line period.

Remote command:

[TRIGger:TV:STANdard](#) on page 321

Signal Polarity

Sets the polarity of the signal. Note that the sync pulse has the opposite polarity, for example, a positive signal has a negative sync pulse.

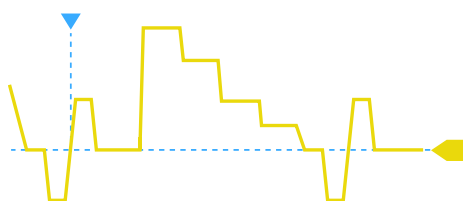

Figure 3-8: Signal with positive polarity and tri-level sync pulse

Remote command:

[TRIGger:TV:POLarity](#) on page 321

Mode

Selects the lines or fields on which the instrument triggers. Available modes depend on the scanning system of the selected standard.

"All fields"	Triggers on the first video line of the frame (progressive scanning) or field (interlaced scanning), for example, to find amplitude differences between the fields.
"Odd fields / Even fields"	Triggers on the first video line of the odd or even field. These modes are available for interlaced scanning (PAL, PAL-M, SECAM, NTSC, 1080i) and progressive segmented frame scanning (1080p/24sF). They can be used, for example, to analyze the components of a video signal.
"All lines"	Triggers on the line start of all video lines, for example, to find maximum video levels.
"Line number"	Triggers on a specified line. Enter the line number in "Line #".

Remote command:

[TRIGger:TV:MODE](#) on page 321

Line

Sets the number of the line to be triggered on if "Mode" is set to "Line number". Usually the lines of the frame are counted, beginning from the frame start.

For NTSC signals, the lines are counted per field, not per frame. Therefore, you have to set the "Field" (odd or even), and the line number in the field.

Remote command:

[TRIGger:TV:LINE](#) on page 322

[TRIGger:TV:LFIeld](#) on page 322

Trigger Level

Sets the trigger level as threshold for the synchronizing pulse. Make sure that the trigger level crosses the synchronizing pulses of the video signal.

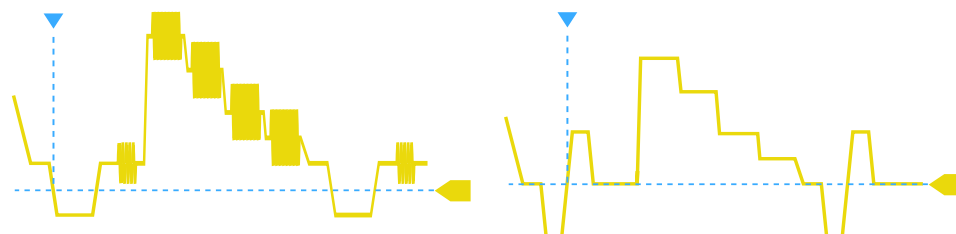

Figure 3-9: Trigger level with bi-level (left) and tri-level (right) sync pulses

Remote command:

[TRIGger:LEVel<m>:VALue](#) on page 316

3.6.5.2 Settings for Custom Video Signals (R&S RTH-K19)

In addition to the standard TV trigger settings, triggering on custom video signals requires a few more settings that describe the signal.

- ▶ [SETUP] key > "Trigger Type" = "Video/TV" > "Standard" = "Custom"

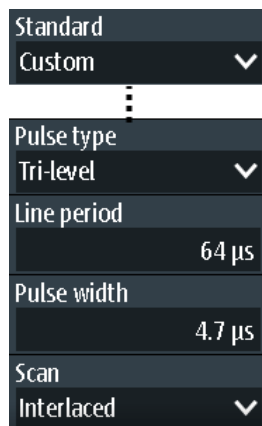

Pulse Type

Sets the type of the sync pulse, either bi-level sync pulse (used in SDTV signals), or tri-level sync pulse (used in HDTV signals).

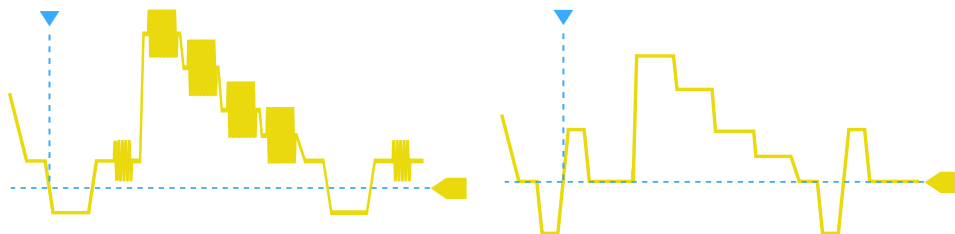

Figure 3-10: Bi-level (left) and tri-level (right) sync pulses

This setting is available for user-defined video signals if "Standard" is set to "Custom".

Remote command:

[TRIGger:TV:CUSTom:STYPe](#) on page 322

Line Period

Sets the duration of a single video line, the time between two successive sync pulses.

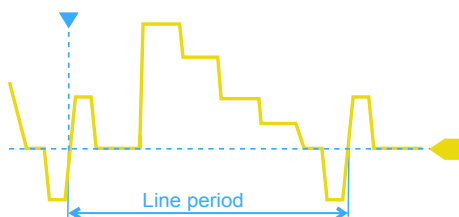

This setting is available for user-defined video signals if "Standard" is set to "Custom".

Remote command:

[TRIGger:TV:CUSTom:LDURation](#) on page 323

Pulse Width

Sets the width of the sync pulse.

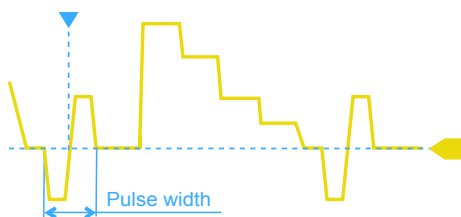

This setting is available for user-defined video signals if "Standard" is set to "Custom".

Remote command:

[TRIGger:TV:CUSTom:SDURation](#) on page 323

Scan

Sets the scanning system.

This setting is available for user-defined video signals if "Standard" is set to "Custom".

- "Interlaced" Interlace scanning uses two fields to create a frame. One field contains all the odd lines (odd, first, or upper filed), the other contains all the even lines of the image (even, second, or lower field). First the lines of the odd filed are processed, then the lines of the even field.
- "Progressive" Progressive scanning is a method to capture, transmit and display all lines of a frame in sequence.
- "Segmented" Progressive segmented frame uses progressive scanning to capture the frame, and interlaced scanning for transmission and display.

Remote command:

[TRIGger:TV:CUSTom:SCANmode](#) on page 323

3.6.6 External Trigger (R&S RTH1002)

The R&S RTH1002 has an edge trigger to trigger on an external signal.

1. Connect the external trigger signal to the DMM input:
 - a) Ground to black COM input.
 - b) Signal to red input.
2. Press the [SETUP] key.
3. Select "Trigger Type" = "External"

 **Description of settings**

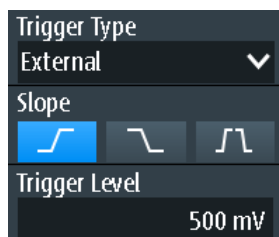

Slope

Sets the edge direction for the trigger. You can trigger on the rising edge, the falling edge, or rising and falling edges of the external signal.

Remote command:

`TRIGger:EXTernal:SLOPe` on page 323

Trigger Level

Sets the trigger voltage level.

Remote command:

`TRIGger:EXTernal:LEVel` on page 323

3.6.7 Pattern Trigger (R&S RTH-K19)

The pattern trigger works like a logic trigger. It provides logical combinations of the input channels and can be used for verifying the operation of digital logic. If the channel states match the desired pattern, the pattern trigger occurs. In addition to the pattern, you can define a timing condition. In this case, the trigger occurs if the pattern definition is true for the defined time.

The pattern trigger has no trigger level, only threshold values to obtain the logic state of signals are required.

► [SETUP] key > "Trigger Type" = "Pattern"

**Description of settings**

Figure 3-11: Pattern trigger

Set Pattern

Defines the pattern: the states of the input channels and their logical combination. If R&S RTH-B1 is installed, active digital channels are also included in the pattern definition.

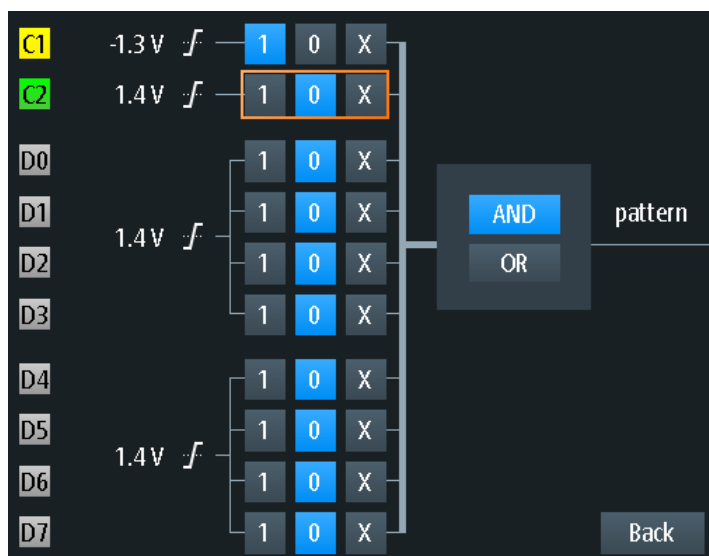

Figure 3-12: Pattern definition

The current threshold is displayed for each channel. For analog channels, the threshold is set in the "Vertical" menu > "Technology". For logic channels, the threshold is set in the "Logic" menu. To adjust the thresholds by the instrument, use "Find Level".

The switches define the state of each channel and set the logical combination:

- "1" The signal value is above the defined threshold.
- "0" The signal value is below the defined threshold.
- "X" The signal state does not matter.
- "AND" If all defined states are true, the logical result of the pattern definition is 1 (true).
- "OR" If at least one of the defined states is true, the logical result of the pattern definition is 1 (true).

Remote command:

[TRIGger:PATTern:STATe\[:CHANnel<m>\]](#) on page 324

[TRIGger:PATTern:STATe:COMBination](#) on page 324

Range

Adds additional time limitation to the defined pattern.

- "None" No time limit is set. If the defined pattern is true, the pattern trigger occurs.
- "Timeout" Defines a minimum time during which the signals match the pattern definition.
- "Longer" If the pattern is true longer than the "Pattern Width" time, the trigger occurs.
- "Shorter" If the pattern is true for a time shorter than "Pattern Width", the trigger occurs.
- "Equal" If the pattern is true for the time "Pattern Width" $\pm \Delta t$ ("Tolerance"), the trigger occurs.

"Unequal"	If the pattern is true for a time shorter than " <i>Pattern Width</i> " - Δt OR longer than " <i>Pattern Width</i> " + Δt , the trigger occurs.
"Inside"	If the pattern is true for a time between "Min Pattern Width" and "Max Pattern Width", the trigger occurs.
"Outside"	If the pattern is true for a time shorter than "Min Pattern Width" OR longer than "Max Pattern Width", the trigger occurs.

Remote command:

[TRIGGER:PATTERN:WIDTH:RANGE](#) on page 325

[TRIGGER:PATTERN:TIMEout\[:TIME\]](#) on page 325

[TRIGGER:PATTERN:WIDTH\[:WIDTH\]](#) on page 325

[TRIGGER:PATTERN:WIDTH:DELTA](#) on page 326

[TRIGGER:PATTERN:WIDTH:MINwidth](#) on page 326

[TRIGGER:PATTERN:WIDTH:MAXwidth](#) on page 326

3.6.8 State Trigger (R&S RTH-K19)

The state trigger verifies if the channel states match the defined pattern at the clock edge. The trigger occurs if the logical combination of the input channels is true at the crossing point of the selected clock edge and the trigger level.

► [SETUP] key > "Trigger Type" = "State"



Description of settings

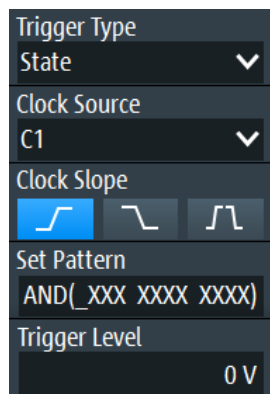

Figure 3-13: State trigger

Clock Source

Selects the input channel of the clock signal.

Remote command:

[TRIGGER:STATe:CSourCe\[:VALue\]](#) on page 327

Clock Slope

Sets the edge of the clock at which the instrument checks the signal states: at the rising edge, the falling edge, or at both edges.

Remote command:

`TRIGger:STATe:CSOURCE:EDGE` on page 327

Set Pattern

Defines the pattern: the states of the input channels and their logical combination. If R&S RTH-B1 is installed, active digital channels are also included in the pattern definition.

For details, see [Chapter 3.6.7, "Pattern Trigger \(R&S RTH-K19\)"](#), on page 64.

Remote command:

`TRIGger:STATe:CHANnel<m>` on page 327

`TRIGger:STATe:COMBination` on page 327

3.6.9 Runt Trigger (R&S RTH-K19)

A runt is a pulse lower than normal in amplitude. The amplitude crosses the first level twice in succession without crossing the second one. In addition to the upper and lower levels, you can define a time limit for the runt in the same way as for width triggers. For example, the runt trigger can detect signal parts remaining below a specified threshold amplitude because I/O ports are in undefined state.

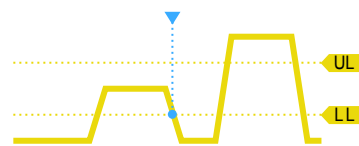

Figure 3-14: Runt trigger without time limits

► [SETUP] key > "Trigger Type" = "Runt"

☰ Description of settings

Trigger Type	Runt		
Source	C1		
Polarity	<input checked="" type="checkbox"/> <input type="checkbox"/> <input type="checkbox"/>		
Range	Longer	Equal	Inside
Upper Trigger Level	Runt Width	Runt Width	Min Runt Width
0 V	4.8 ns	4.8 ns	4 ns
Lower Trigger Level	Upper Trigger Level	±Tolerance	Max Runt Width
0 V	0 V	800 ps	5.6 ns
	Lower Trigger Level	Upper Trigger Level	Upper Trigger Level
	0 V	0 V	0 V
		Lower Trigger Level	Lower Trigger Level
		0 V	0 V

Upper Trigger Level / Lower Trigger Level

Set the upper and lower voltage thresholds for the runt trigger. The levels define the minimum and maximum runt amplitudes.

You can also press the [Level] key to toggle the upper and lower levels, and turn the wheel to adjust the focused level. If the focus is on a trigger level, pressing the wheel also toggles the levels.

Remote command:

[TRIGger:LEVel<m>:RUNT:UPPer](#) on page 328

[TRIGger:LEVel<m>:RUNT:LOWer](#) on page 328

Polarity

Sets the pulse polarity, that is the direction of the first pulse slope. You can trigger on:

- Positive going pulses. The width is defined from the rising to the falling edge.
- Negative going pulses. The width is defined from the falling to the rising edge.
- Both positive and negative going pulses

Remote command:

[TRIGger:RUNT:POLarity](#) on page 328

Range

Defines an additional time limit of the runt pulse.

"Any runt" triggers on all runts fulfilling the level condition, without time limitation. The other comparisons are the same as for the width trigger, see "[Range](#)" on page 58.

Remote command:

[TRIGger:RUNT:RANGe](#) on page 328

Runt Width

Sets the width for comparisons equal, unequal, shorter, and longer.

Remote command:

[TRIGger:RUNT:WIDTh](#) on page 329

±Tolerance

Sets a tolerance range Δt to the specified [Runt Width](#) if the comparison range is equal or unequal.

Remote command:

[TRIGger:RUNT:DELTA](#) on page 329

Min Runt Width / Max Runt Width

Set the lower and upper time limits if "Inside" or "Outside" is set for comparison.

Remote command:

[TRIGger:RUNT:MINWidth](#) on page 329

[TRIGger:RUNT:MAXWidth](#) on page 329

3.6.10 Slew Rate Trigger (R&S RTH-K19)

The slew rate trigger is also known as transition trigger. It triggers if the transition time from the lower to higher voltage level (or vice versa) is shorter or longer as defined, or outside or inside a specified time range.

The slew rate trigger finds slew rates faster than expected or permissible to avoid overshooting and other interfering effects. It also detects slow edges violating the timing in pulse series.

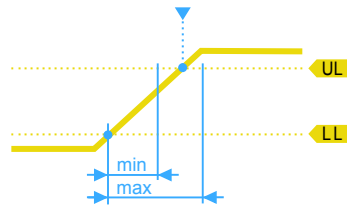

Figure 3-15: Slew rate trigger, transition time inside a range ($t > \text{min time AND } t < \text{max time}$)

► [SETUP] key > "Trigger Type" = "Slew rate"

As source, only analog channels are available.



Description of settings

Trigger Type	Slew Rate	
Source	C1	
Slope		
Range	Shorter	Inside
Time	4.8 ns	4 ns
Upper Trigger Level	0 V	5.6 ns
Lower Trigger Level	0 V	0 V
	±Tolerance	Upper Trigger Level
	800 ps	0 V
	Upper Trigger Level	Lower Trigger Level
	0 V	0 V

Upper Trigger Level / Lower Trigger Level

Set the upper and lower voltage thresholds for the slew rate trigger. The time measurement starts when the signal crosses the first trigger level, and stops when the signal crosses the second level. The first trigger level is the upper or lower level depending on the selected slope.



Remote command:

`TRIGger:LEVel<m>:SLEW:UPPer` on page 330

`TRIGger:LEVel<m>:SLEW:LOWer` on page 330

Slope

Sets the edge direction for the trigger. You can trigger on:

-  rising edge, that is a positive voltage change
-  falling edge, that is a negative voltage change
-  rising and falling edge

Remote command:

`TRIGger:SLEW:SLOPe` on page 330

Range

Defines the time limits of the slew rate. The comparisons are the same as for the width trigger, see "Range" on page 58.

Remote command:

`TRIGger:SLEW:RANGe` on page 330

Time

Sets the slew rate for comparisons equal, unequal, shorter, and longer.

Remote command:

`TRIGger:SLEW:RATE` on page 331

±Tolerance

Sets a tolerance range Δt to the specified [Time](#) if the comparison range is equal or unequal.

Remote command:

`TRIGger:SLEW:DELTA` on page 331

Min Time / Max Time

Set the lower and upper time limits if "Inside" or "Outside" is set for comparison.

Remote command:

`TRIGger:SLEW:MINwidth` on page 331

`TRIGger:SLEW:MAXwidth` on page 331

3.6.11 Data2Clock Trigger (R&S RTH-K19)

With the Data2Clock trigger - also known as setup/hold trigger - you can analyze the relative timing between two signals: a data signal and the synchronous clock signal. Many systems require, that the data signal must be steady for some time before and after the clock edge, for example, the data transmission on parallel interfaces.

The reference point for the time measurement is defined by clock level and clock edge.

- ▶ [SETUP] key > "Trigger Type" = "Data2Clk"

Description of settings

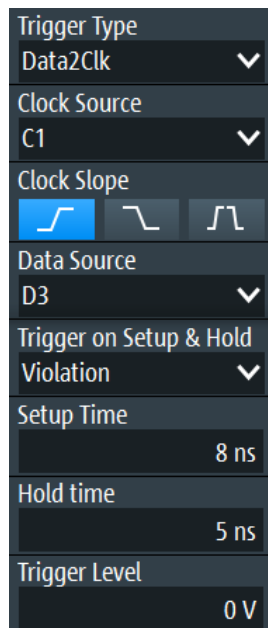

Figure 3-16: Data2Clock trigger

Clock Source

Selects the input channel of the clock signal.

Remote command:

[TRIGger:DATatoclock:CSource\[:VALue\]](#) on page 332

Clock Slope

Sets the edge of the clock signal: rising, falling, or both edges. The time reference point for the setup and hold time is the crossing point of the clock edge and the trigger level.

Remote command:

[TRIGger:DATatoclock:CSource:EDGE](#) on page 332

Data Source

Selects the input channel of the data signal.

Remote command:

[TRIGger:DATatoclock:DSource\[:VALue\]](#) on page 332

Trigger on Setup & Hold

Selects how a violation of the setup and hold time is handled.

"Violation" Triggers on a violation of the setup or hold time

"OK" Triggers if setup and hold time keep the limits.

Remote command:

[TRIGger:DATatoclock:CONDition](#) on page 332

Setup Time

Sets the minimum time before the clock edge while the data signal must stay steady.

The setup time can be negative. In this case, the hold time is always positive. If you set a negative setup time, the hold time is adjusted by the instrument.

Remote command:

`TRIGger:DATatoclock:STIME` on page 333

Hold Time

Sets the minimum time after the clock edge while the data signal must stay steady.

The hold time can be negative. In this case, the setup time is always positive. If you set a negative hold time, the setup time is adjusted by the instrument.

Remote command:

`TRIGger:DATatoclock:HTIME` on page 333

3.6.12 Serial Pattern Trigger (R&S RTH-K19)

The serial pattern event is used to trigger on signals with serial data patterns in relation to a clock signal - for example, on bus signals like the I²C bus. The trigger occurs during the reception of the last bit of the defined pattern.

3.6.12.1 Pattern Definition

The pattern defines the bits of the serial data to be found in the data stream.



The pattern definition described here is for the serial pattern trigger; however, a very similar pattern editor is available for other functions, such as protocol-specific triggers.

When you tap the pattern field, a pattern editor is displayed. The current bit definition in binary and hexadecimal format is displayed at the top of the editor, a virtual keypad is displayed beneath it. To define a bit, select the bit in the displayed pattern, then select the bit value from the displayed keypad. The currently selected bit is indicated by a blue background.

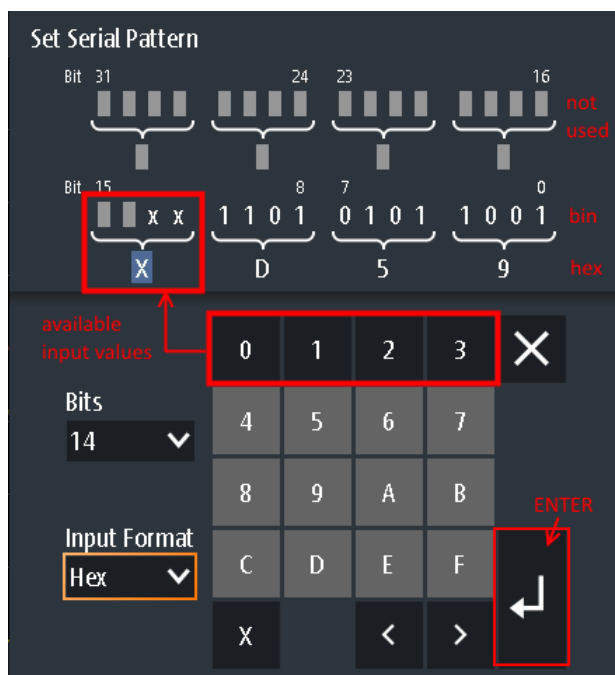

Figure 3-17: Pattern editor for 14-bit pattern in hexadecimal format

The maximum length of the pattern is 32 bit, however you can reduce the number of bits. The available bits are initially indicated by 'X', while the unused bits are indicated by gray squares. An 'X' indicates that the logical level for the bit is not relevant (do not care). Once you enter a value for the selected bit, the 'X' is overwritten.

You can enter the pattern in binary or hexadecimal format. Depending on which bit you select in the pattern display, binary or hexadecimal format is automatically selected for input. In binary format, each bit is defined individually, and only the digits 0 and 1 are available for input. In hexadecimal format, 4 bits are defined at the same time by the selected hexadecimal value. If fewer than 4 bits are available (due to the total number of bits), only those hexadecimal values are available that can be defined with the remaining number of bits. For example, for a total number of 14 bits, 3x4 bits can be defined by any hexadecimal value. The remaining 2 bits can define a 0, 1, 2, or 3 (as shown in Figure 3-17).

To store the defined pattern, select "Enter". The pattern editor is closed and the pattern is inserted in the pattern settings field.

3.6.12.2 Serial Pattern Trigger Settings

Access: (Trigger) [SETUP] key > "Trigger Type" = "Serial Pattern"

 Description of settings

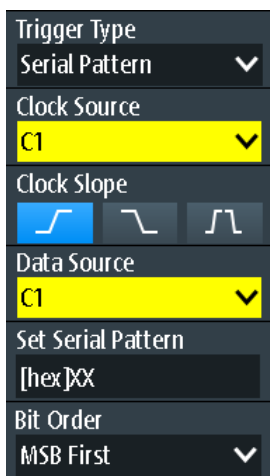

Figure 3-18: Serial pattern trigger

Clock Source..... 74
 Clock Slope..... 74
 Data Source..... 74
 Set Serial Pattern..... 74
 Bit Order..... 75

Clock Source



Selects the input channel of the clock signal.

Remote command:

[TRIGger:SPATtern:CSourCe\[:VALue\]](#) on page 334

Clock Slope

Sets the edge at which the data value is sampled.

-  rising edge
-  falling edge
-  rising and falling edges are considered (double data rate).

At double data rate, "First Clock Edge of Pattern" defines the edge at which the first bit of the pattern is sampled: at the rising clock edge, falling clock edge, or the first edge that is detected ("Either").

Remote command:

[TRIGger:SPATtern:CSourCe:EDGE](#) on page 334

[TRIGger:SPATtern:CSourCe:FIRStedge](#) on page 334

Data Source

Selects the input channel of the data signal.

Remote command:

[TRIGger:SPATtern:DSourCe\[:VALue\]](#) on page 333

Set Serial Pattern

The pattern defines the bits of the serial data to be found in the data stream.

See also [Chapter 3.6.12.1, "Pattern Definition"](#), on page 72.

Remote command:

[TRIGger:SPATtern:PATtern](#) on page 334

Bit Order

Defines if the data words start with MSB (most significant bit) or LSB (least significant bit).

Remote command:

[TRIGger:SPATtern:ORDer](#) on page 334

3.6.13 Timeout Trigger (R&S RTH-K19)

The timeout trigger checks if the signal stays above or below the trigger level for a specified time lapse. In other words, the trigger occurs if the signal does not cross the trigger level during the specified time.

► [SETUP] key > "Trigger Type" = "Timeout"



Description of settings

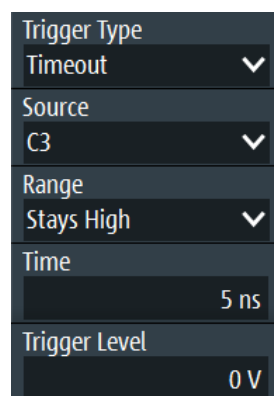

Figure 3-19: Timeout trigger

Range

Selects the relation of the signal level to the trigger level:

"Stays High" The signal level stays above the trigger level.

"Stays Low" The signal level stays below the trigger level.

"High or Low" The signal level stays above or below the trigger level.

Remote command:

[TRIGger:TIMEout:RANGe](#) on page 335

Time

Defines the time limit for the timeout at which the instrument triggers.

Remote command:

[TRIGger:TIMEout:TIME](#) on page 335

3.6.14 Interval Trigger (R&S RTH-K19)

The interval trigger analyzes the time between two pulses.

► [SETUP] key > "Trigger Type" = "Interval"

Description of settings



Figure 3-20: Interval trigger

Slope

Sets the edge for the trigger. You can analyze the interval between positive edges or between negative edges.

Remote command:

[TRIGger:INTerval:SLOPe](#) on page 335

Range

Defines how the time range of an interval is defined. The comparisons are the same as for the width trigger, see "[Range](#)" on page 58.

Remote command:

[TRIGger:INTerval:RANGe](#) on page 336

Interval Width

Sets the time between two pulses for comparisons equal, unequal, shorter, and longer.

Remote command:

[TRIGger:INTerval:WIDTh](#) on page 336

±Tolerance

Sets a tolerance range Δt to the specified [Interval Width](#) if the comparison range is equal or unequal.

Remote command:

[TRIGger:INTerval:DELTA](#) on page 336

Min Interval Width / Max Interval Width

Set the lower and upper time limits of the interval if "Inside" or "Outside" is set for comparison.

Remote command:

[TRIGger:INTerval:MINWidth](#) on page 336

[TRIGger:INTerval:MAXWidth](#) on page 337

3.6.15 Window Trigger (R&S RTH-K19)

The window trigger checks the signal run in relation to a "window" that is formed by the upper and lower voltage levels. The trigger occurs, if the waveform enters or leaves the window, or if the waveform stays inside or outside for a defined time range.

With the window trigger, you can display longer transient effects.

▶ [SETUP] key > "Trigger Type" = "Window"

**Description of settings**

Figure 3-21: Window trigger

Vertical Condition

Selects how the signal run is compared with the window:

"Enter"	Triggers when the signal crosses the upper or lower level and thus enters the window made up of these two levels.
"Exit"	Triggers when the signal leaves the window.
"Stay Inside"	Triggers if the signal stays between the upper and lower level for a specified time. The time is defined in various ways by the "Range" conditions.
"Stay Outside"	Triggers if the signal stays above the upper level or below the lower level for a specified time. The time is defined in various ways by the "Range" conditions.

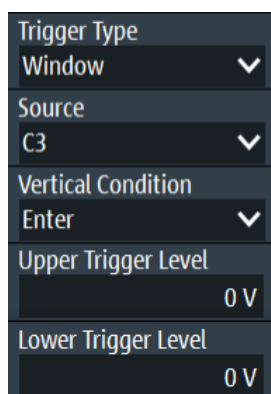
Remote command:

[TRIGger:WINDow:RANGe](#) on page 338

Upper Trigger Level / Lower Trigger Level

Set the upper and lower voltage thresholds for the window trigger. The trigger levels are the vertical window limits.

Remote command:

[TRIGger:LEVel<m>:WINDow:UPPer](#) on page 337

[TRIGger:LEVel<m>:WINDow:LOWer](#) on page 337

Range

Selects how the time limit of the window is defined. Time conditioning is available for the vertical conditions "Stay Inside" and "Stay Outside".

"Longer"	Triggers if the signal crosses the upper or lower level after the specified "Width" time is reached.
"Shorter"	Triggers if the signal crosses the upper or lower level before the specified "Width" time is reached.
"Equal"	Triggers if the signal stays inside or outside the vertical window limits for the time "Width" "±Tolerance".
"Unequal"	Triggers if the signal stays inside or outside the vertical window limits for a time unequal to "Width" "±Tolerance"
"Inside"	Triggers if the signal stays inside or outside the vertical window limits at least for the time "Min Width" and for "Max Width" at the most.
"Outside"	"Outside" is the opposite definition of "Inside". The trigger occurs if the signal stays inside or outside the vertical window limits for a time shorter than "Min Width" or longer than "Max Width".

Remote command:

[TRIGger:WINDow:TIME](#) on page 337

[TRIGger:WINDow:WIDTH](#) on page 338

[TRIGger:WINDow:DELTA](#) on page 338

[TRIGger:WINDow:MINWidth](#) on page 339

[TRIGger:WINDow:MAXWidth](#) on page 339

3.6.16 Protocol Trigger (R&S RTH-K1, -K2, -K3, -K9 and -K10)

The protocol trigger requires at least one of the serial protocol options.

For protocol setup and trigger settings, see:

- [Chapter 9.2.3, "I2C Trigger Settings"](#), on page 186
- [Chapter 9.3.3, "SPI Trigger Settings"](#), on page 195
- [Chapter 9.4.3, "UART Trigger Settings"](#), on page 202
- [Chapter 9.5.3, "CAN Trigger Settings"](#), on page 211
- [Chapter 9.6.3, "LIN Trigger Settings"](#), on page 224
- [Chapter 9.7.3, "SENT Trigger Settings"](#), on page 237

4 Waveform Analysis

4.1 Zoom

The zoom magnifies a part of the waveform to view more details with a maximum zoom factor of 100.



To activate the zoom:

- ▶ Press the [ZOOM] key.

The zoom is applied to all active analog and digital channels and math waveforms. The waveforms are displayed with a shorter time scale while the vertical scale remains unchanged. The zoom indicator on the bottom shows the size and position of the zoom area in the waveform.

To adjust the zoom using the wheel:

1. Check if the zoom has the focus - an orange frame on the zoom indicator. If not, press the [ZOOM] key.

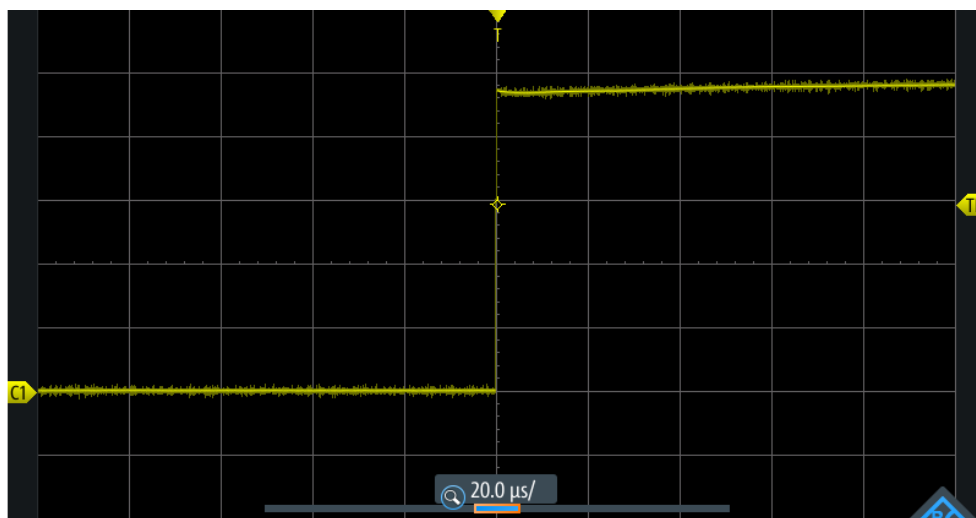

Figure 4-1: Zoomed waveform and zoom indicator with focus on zoom scale



Figure 4-2: Zoom indicator with focus on zoom position

2. Turn the wheel.
Depending on the focus, the position of the zoom area or the zoom scale (time base of the zoom) is adjusted.
3. Press the wheel to toggle the setting.

- Turn the wheel to adjust the other parameter.

To position the zoom on the touchscreen:

- ▶ Use one of these methods:
 - Drag the zoom area in the zoom indicator.
 - Drag the trigger position marker.
 - In zoom mode, moving the trigger position marker changes the zoom position and not the horizontal position of the waveform.

To zoom in and out using pinching & spreading gestures

You can zoom in and out as you do on a mobile phone or tablet.

- To zoom in, touch the screen with two fingers and spread the fingers.
- To zoom out, touch the screen with two fingers and pinch them together.

To adjust the zoom numerically in the Zoom menu:

- Press and hold the [ZOOM] key until the "Zoom" menu opens.
- Adjust scale and position of the zoom in the menu.

To analyze the zoomed signal, you can use cursor measurements.



Description of settings

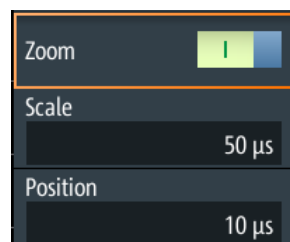

Zoom

Enables or disables the zoom.

Remote command:

[ZOOM:ENABLe](#) on page 339

Scale

Sets the time scale of the zoomed waveform.

Remote command:

[ZOOM:SCALe](#) on page 340

Position

Sets the center position of the zoomed area in relation to the trigger point.

Note: The zoom overview also considers the horizontal position of the trigger point. If the horizontal position is $\neq 0$, the trigger point is not in the middle. In this case, the zoom area in the overview is also shifted, even if the zoom position is 0.

Remote command:
[ZOOM:POSition](#) on page 340

4.2 Automatic Measurements

You can perform up to four different measurements simultaneously.

4.2.1 Performing Automatic Measurements

To start and stop the last configured measurements

- ▶ Press the [Meas] key.

To configure automatic measurements in the Meas menu

1. Press and hold the [Meas] key until the "Meas" menu opens.
2. Select the number of the measurement that you want to configure.
3. If the measurement is disabled, enable "State".
4. Select the "Type".
The selection list shows all available measurement types.
5. Select the "Source".
The selection list shows all active sources that are allowed for the selected measurement type.
6. Some measurement types require additional settings. Scroll down the menu and adjust the additional settings if necessary.

4.2.2 Measurement Results

The measurement results are shown on the left-top side of the screen.

C1	T = 100.1 ns	C2	Mean = 2.876 μ V
C3	RMS = 35.37 mV	C4	Dty+ = 50.00 %

Figure 4-3: Results of 4 active measurements

If a result cannot be determined, "---" is displayed. Adjust the horizontal and vertical settings if the instrument cannot measure.

If the measurement result is outside the measurement range and clipping occurs, the results are marked with < (underflow) or > (overflow). Adjust the vertical scale to get valid results.

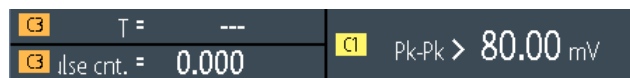

Figure 4-4: Invalid measurement results

Meas1 = period measurement on C3, no complete period detected
 Meas2 = peak to peak measurement on C1, waveform is clipped
 Meas3 = pulse count on C3, no pulse detected

Remote commands:



- [MEASurement<m>:RESult:ACTual?](#) on page 342
- [MEASurement<m>:RESult:LIMit?](#) on page 342

4.2.3 Measurement Types

The R&S RTH provides 33 measurement types to measure time, amplitude and power characteristics, and to count pulses and edges.

All measurement types that require only one source are also available for gated measurements using [Cursor] > "Type" = "Measure".

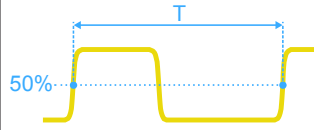
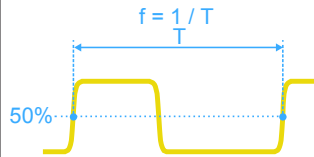
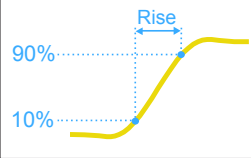
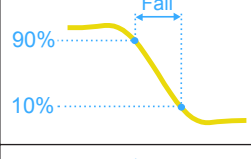
4.2.3.1 Time Measurements



Meas. type	Symbol	Description	Graphic / formula	Source
Period	T in s	Time of the first period, measured on the 50% level. The measurement requires at least one complete period of the signal.		Analog, math, logic
Frequency	f in Hz	Frequency of the signal, reciprocal value of the measured first period.		Analog, math, logic
Rise time	tR in s	Rise time of the first rising edge, the time it takes the signal to rise from the 10% level to the 90% level.		Analog, math
Fall time	tF in s	Fall time of the first falling edge, the time it takes the signal to fall from the 90% level to the 10% level.		Analog, math
Positive pulse width	t+ in s	Duration of the first positive pulse: time between a rising edge and the following falling edge measured on the 50% level.		Analog, math, logic

Meas. type	Symbol	Description	Graphic / formula	Source
Negative pulse width	t- in s	Duration of the first negative pulse: time between a falling edge and the following rising edge measured on the 50% level.		Analog, math, logic
Positive duty cycle	Dty+ in %	Width of the first positive pulse in relation to the period in %. The measurement requires at least one complete period of the signal.	$Dty+ = t+ / T * 100\%$ 	Analog, math, logic
Negative duty cycle	Dty- in %	Width of the first negative pulse in relation to the period in %. The measurement requires at least one complete period of the signal.	$Dty- = t- / T * 100\%$ 	Analog, math, logic
Delay	Δt in s	Time difference between two slopes of the same or different waveforms, measured on the 50% level. Not available for cursor measurements		2 sources: analog, math, logic
Phase	∠ in °	Phase difference between two waveforms, measured on the 50% level. Not available for cursor measurements	$Phase = \Delta t / T * 360^\circ$ 	2 sources: analog, math, logic

4.2.3.2 Amplitude Measurements

The unit of most amplitude measurement results depends on the measured source.

Meas. type	Symbol	Description	Graphic / formula	Source
Mean value	Mean	Arithmetic average of the complete displayed waveform.	$Mean = \frac{1}{N} \sum_{k=1}^N x_k$	Analog, math, logic
RMS value	RMS	RMS (root mean square) value of the voltage of the complete displayed waveform.	$RMS = \sqrt{\frac{1}{N} \sum_{k=1}^N x_k^2}$	Analog, math
Crest factor	Crest	The crest factor is also known as peak-to-average ratio. It is the maximum value divided by the RMS value of the displayed waveform.	$Crest = \frac{Max x_k }{RMS}$	Analog, math

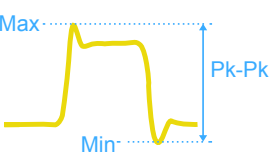
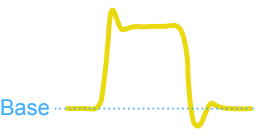
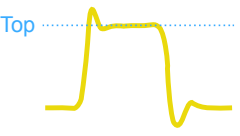
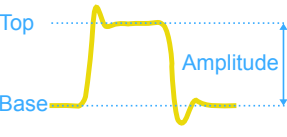
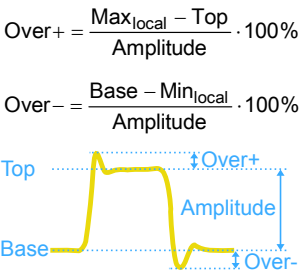
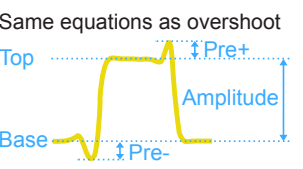
Meas. type	Symbol	Description	Graphic / formula	Source
Standard deviation	σ	Standard deviation of the displayed waveform.	$\sigma = \sqrt{\frac{1}{N-1} \sum_{k=1}^N (x_k - \text{Mean})^2}$	Analog, math
Minimum	Min	Minimum value within the displayed waveform.		Analog, math
Maximum	Max	Maximum value within the displayed waveform.		Analog, math
Peak to peak	Pk-Pk	Difference of maximum and minimum values.		Analog, math
Base level	Base	Low level of the displayed waveform - the lower maximum of the sample distribution. The measurement requires at least one complete period of the signal.		Analog, math
Top level	Top	High level of the displayed waveform - the upper maximum of the sample distribution. The measurement requires at least one complete period of the signal.		Analog, math
Amplitude	Amp	Difference between the top level and the base level of the signal. The measurement requires at least one complete period of the signal.		Analog, math
Overshoot	Over in %	Overshoot of a square wave <i>after</i> a rising or falling edge. It is calculated from measurement values top level, base level, local maximum, local minimum, and amplitude.	$\text{Over+} = \frac{\text{Max}_{\text{local}} - \text{Top}}{\text{Amplitude}} \cdot 100\%$ $\text{Over-} = \frac{\text{Base} - \text{Min}_{\text{local}}}{\text{Amplitude}} \cdot 100\%$ 	Analog, math
Preshoot	Pre in %	Overshoot of a square wave <i>before</i> a rising or falling edge.	<p>Same equations as overshoot</p> 	Analog, math

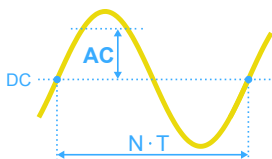
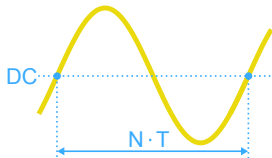
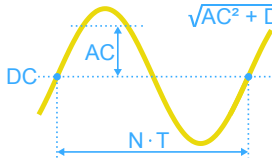
Meas. type	Symbol	Description	Graphic / formula	Source
AC	AC in V	RMS value of the AC part of a periodic signal, calculated over all periods on the display. The AC result is derived from the DC and AC+DC results.		Analog, math
DC	DC in V	Mean value of a periodic signal, calculated over all periods on the display. If no complete period is available, only the mean value of the visible waveform is calculated.		Analog, math
AC+DC	AC+DC in V	RMS value of a periodic signal, calculated over all periods on the display. If no complete period is available, only the RMS value of the visible waveform is calculated.		Analog, math

4.2.3.3 Counting

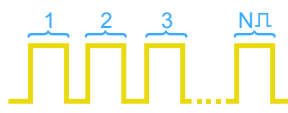
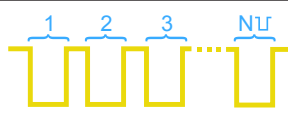
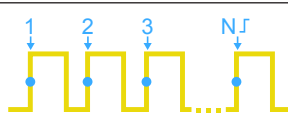
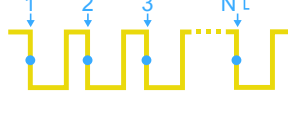
Meas. type	Symbol	Description	Graphic / formula	Sources
Positive pulse count	Cnt+	Number of positive pulses on the display. The mean value of the signal is determined. If the signal passes the mean value, an edge is counted. A positive pulse is counted if a rising edge and a following falling edge are detected.		Analog, math, logic
Negative pulse count	Cnt-	Number of negative pulses on the display. The mean value of the signal is determined. If the signal passes the mean value, an edge is counted. A negative pulse is counted if a falling edge and a following rising edge are detected.		Analog, math, logic
Rising edge count	Cnt↑	Number of rising edges on the display. The instrument determines the mean value of the signal and counts an edge every time the signal passes the mean value in the specified direction.		Analog, math, logic
Falling edge count	Cnt↓	Number of falling edges on the display. The instrument determines the mean value of the signal and counts an edge every time the signal passes the mean value in the specified direction.		Analog, math, logic

4.2.3.4 Area Measurements

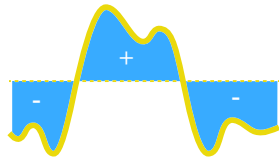
Meas. type	Symbol	Description	Graphic / formula	Sources
Area	Area in Vs or As	Area between the waveform and the x-axis. T_{Eval} is the evaluation time, time of a full waveform or limited by cursor lines.	$A_{Ref} = \frac{T_{Eval}}{N_{Eval}} \cdot \sum_{i=1}^{N_{Eval}} x(i)$ 	Analog, math

4.2.3.5 Power Measurements

Power measurements require two sources, one voltage source and one current source. They are not available for cursor measurements and logic channel sources.

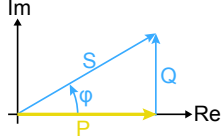
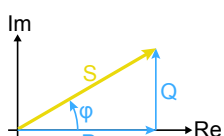
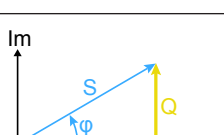
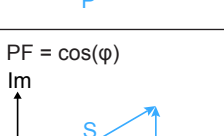
Meas. type	Symbol	Description	Graphic / formula	Sources
Active power	P in W	Active or real power is the energy of the system that can be used to do work.		2 sources: analog, math
Apparent power	S in VA	Complex power S is the magnitude of the vector sum of real and reactive power.		2 sources: analog, math
Reactive power	Q in var	Reactive power is temporally stored in a system because of the inductive and capacitive elements.		2 sources: analog, math
Power factor	PF (no unit)	Power factor is a measure of the system efficiency. The value varies between -1 and 1.	$PF = \cos(\varphi)$ 	2 sources: analog, math

4.2.3.6 PWM Measurements

Pulse width modulated signals are commonly used in power electronics. For drive control, the PWM signal contains a sinusoidal signal with a fundamental frequency f and the associated RMS voltage, which an AC motor reacts on. The PWM measurements of R&S RTH display the frequency and RMS value of this fundamental. This also works

for bipolar PWM signals, as it can be observed in multi-level drive controls or in a differential phase to phase measurement (L1-L2).

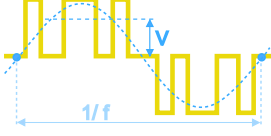
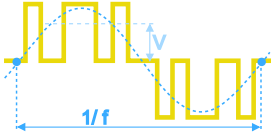
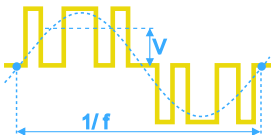
Meas. type	Symbol	Description	Graphic / formula	Sources
V PWM	V PWM in V	RMS voltage of the fundamental in the PWM signal, measured over the complete displayed waveform.		Analog, math
f PWM	f PWM in Hz	Fundamental frequency in the PWM signal, measured over the complete displayed waveform.		Analog, math
V/f PWM	V/f in Vs	Ratio of RMS fundamental voltage over fundamental frequency of the PWM signal, measured over the complete displayed waveform.		Analog, math

4.2.4 Measurement Settings

Access: "Meas" menu

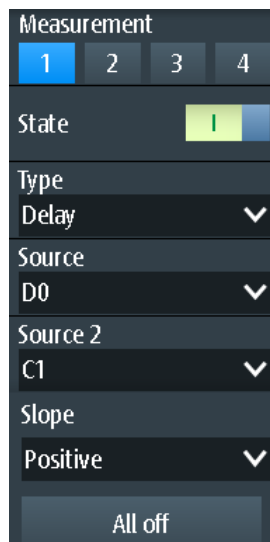

Measurement

Selects the measurement to be configured in the menu. You can perform up to four different measurements simultaneously.

State

Enables or disables the selected measurement.

Remote command:

`MEASurement<m>:ENABle` on page 340

Type

Selects the measurement type. For a detailed description, see [Chapter 4.2.3, "Measurement Types"](#), on page 82.

Remote command:

`MEASurement<m>:TYPE` on page 341

Source / Source 2

Defines the waveform to be measured. For delay, phase, and power measurements, 2 sources are required.

The sources can be any active input signal, math or reference waveform. Available source waveforms depend on the measurement type, see [Chapter 4.2.3, "Measurement Types"](#), on page 82.

Remote command:

`MEASurement<m>:SOURce` on page 341

All off

Disables all active measurements.

Remote command:

`MEASurement<m>:AOFF` on page 342

Slope

Sets the slope for the delay measurement type.

"Positive" Delay between the first rising edge of each source waveform.

"Negative" Delay between the first falling edge of each source waveform.

"Either" Delay between the first edge of each source waveform, no matter if it is rising or falling.

Remote command:

`MEASurement<m>:DELay:SLOPe` on page 342

4.3 Cursor Measurements

The cursor measurement determines the results at the current cursor positions, or performs gated automatic measurements between the cursor lines. The cursors can be positioned manually at fixed positions, or they can follow the waveform.

You can perform cursor measurements on analog input signals, math waveform, XY-diagram, as well as on logic channels (requires option R&S RTH-B1).

Cursor measurements on spectrum displays are also available, if the option R&S RTH-K18 is installed (see [Chapter 6.2.7, "Cursor Measurements on Spectrums"](#), on page 129).

4.3.1 Performing Cursor Measurements

To start and stop the last configured measurement

- ▶ Press the [Cursor] key.

To configure the cursor measurement in the Cursor menu

1. Press and hold the [Cursor] key until the "Cursor" menu opens.
2. Select the "Type" of the cursor.
3. For horizontal, track and measure types, select the "Source" channel that you want to measure.
4. Scroll down the menu and adjust the additional settings, which are required for the selected cursor type.

4.3.2 Cursor Types and Results

The results of cursor measurements are displayed at the top of the display. 4 cursor types are available.

Vertical cursors

For vertical cursors, two results are displayed by default: the absolute value of the time difference between the cursor lines Δt and its inverse value $1/\Delta t$. Optionally, the positions of the cursor lines t_1 and t_2 are also measured. The results are time values and do not depend on any waveform, thus no source is required.



- [CURSor:TDELta?](#) on page 345
- [CURSor:ITDelta?](#) on page 345
- [CURSor:X1Position](#) on page 345
- [CURSor:X2Position](#) on page 345

Horizontal cursors

For horizontal cursors, the vertical values of the cursor positions y_1 and y_2 are measured. These are usually voltage or current values. The absolute value of the difference between the positions Δy is also displayed.



- [CURSor:Y1Position](#) on page 346
- [CURSor:Y2Position](#) on page 346
- [CURSor:DELTA?](#) on page 345

Track cursors

Two vertical cursor lines are coupled to the waveform. The instrument measures the vertical values y_1 and y_2 of the crossings between the cursor lines and the waveform. It also measures the absolute values of the difference between the positions Δy and of the time difference between the cursor lines Δt

Cursor Track	C1	$y_1 = 384.3 \text{ mV}$	$\Delta y = 13.41 \text{ mV}$
		$y_2 = 397.7 \text{ mV}$	$\Delta t = 600.0 \text{ ns}$

- [CURSor:Y1Amplitude?](#) on page 346
- [CURSor:Y2Amplitude?](#) on page 346
- [CURSor:DELTA?](#) on page 345
- [CURSor:TDELTA?](#) on page 345

Measurements

Two vertical cursor lines define a gate for two parallel automatic measurements. All automatic measurements that need only one source are available. Delay, phase, and power measurements are not provided for cursor measurements, they require two sources.

See [Chapter 4.2.3, "Measurement Types"](#), on page 82.

Cursor Meas	C1	$T = 99.85 \text{ ns}$	$Rise = 27.13 \text{ ns}$
----------------	-----------	------------------------	---------------------------

If the measurement result is outside the measurement range and clipping occurs, the results are marked with < (underflow) or > (overflow). Adjust the vertical scale to get valid results.

- [CURSor:MEASurement<m>:RESult:ACTual?](#) on page 346
- [CURSor:MEASurement<m>:RESult:LIMit?](#) on page 346

4.3.3 Settings for Cursor Measurements

Access: "Cursor" menu

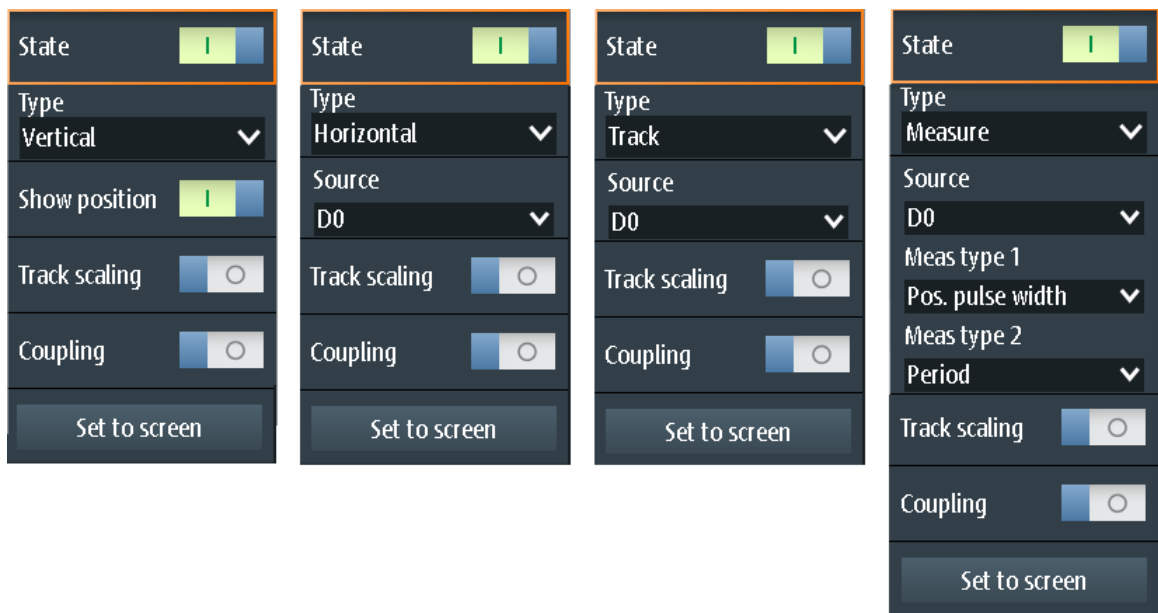
**State**

Enables or disables the cursor measurement.

Remote command:

[CURSor:STATe](#) on page 343

Type

Defines the type of the cursor measurement.

For details, see [Chapter 4.3.2, "Cursor Types and Results"](#), on page 89.

"Vertical"	Displays two vertical cursor lines and measures their timing parameters.
"Horizontal"	Displays two horizontal cursor lines and measures their amplitude parameters.
"Track"	Displays two vertical cursor lines and couples them to the source waveform. The amplitude characteristics and the time difference of the crossing points are measured.
"Measure"	Displays two vertical cursor lines that define a gate for two simultaneous automatic measurements.

Remote command:

[CURSor:FUNction](#) on page 343

Source

Defines the source on which the cursor measurement is performed. The source can be any active analog or digital input signal, math waveform, or bus (requires option).

The source setting is not available for the cursor type "Vertical", and for measurements in the XY-diagram.

Remote command:

[CURSor:SOURce](#) on page 343

Show Position

Shows the position values of the vertical cursor lines t1 and t2 in the measurement results. The setting is only available for the vertical cursor type.

Cursor	t1 = -285.6 ns	Δt = 600.0 ns
Vert.	t2 = 314.4 ns	1/ Δt = 1.667 MHz

Meas Type 1 / Meas Type 2

Set the automatic measurements to be performed on the source waveform between the cursor lines. The setting is only available for the "Measure" cursor type.

All automatic measurements that need only one source are available. Delay, phase, and power measurements are not provided for cursor measurements, they require two sources.

For a description of the measurement types, see [Chapter 4.2.3, "Measurement Types"](#), on page 82.

Remote command:

[CURSor:MEASurement<m>:TYPE](#) on page 344

Track Scaling

If enabled, the position of the cursor lines is adjusted if the vertical or horizontal scales are changed. The cursor lines keep their relative position to the waveform.

If disabled, the cursor lines remain on their position on the display if the scaling is changed.

Remote command:

[CURSor:SCPLing](#) on page 344

Coupling

Couples the cursor lines so that the distance between the two lines remains the same if one cursor is moved.

Remote command:

[CURSor:COUPling](#) on page 344

Set to Screen

Sets the cursors to a default position on the screen. This is helpful if the cursors have disappeared from the display or need to be moved for a larger distance.

Remote command:

[CURSor:SCReen](#) on page 344

4.4 Mathematics

A math waveform is a calculated waveform. You can calculate data out of one or two different sources using several predefined operations.

- ▶ To configure the math waveform, press and hold the [MATH] key until the menu opens.

- ▶ To activate or deactivate the last configured math waveform, shortly press the [MATH] key.
- ▶ To adjust vertical scale and position of the math waveform, use the [RANGE] and [POS] keys.

You can analyze math waveforms in the same way as channel waveforms: use zoom, perform automatic and cursor measurements, save as reference waveform, and perform mask tests.



Description of settings

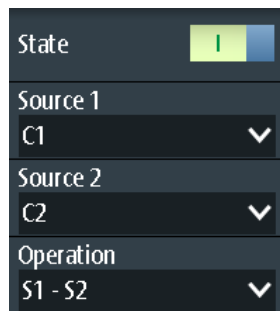

State

Activates the waveform and displays it.

Remote command:

[REFCurve:STATe](#) on page 349

[CALCulate:MATH:STATe](#) on page 347

Source 1 / Source 2

Sets the source(s) for the defined mathematic operation.

Operation

Select an operation to calculate the math waveform.

"S1 + S2"

Addition: Adds the values of "Source 1" and "Source 2".



"S1 - S2"

Subtraction: Subtracts the values of "Source 2" from the values of "Source 1".



"S1 * S2" *Multiplication:* Multiplies the values of "Source 1" and "Source 2".



"-S1," *Inverse:* Inverts all voltage values of "Source 1", i.e. all values are mirrored at the ground level. Thus, a positive voltage offset becomes negative.



"|S1|" *Abs. Value:* Calculates the absolute value of "Source 1". All negative values are inverted to positive values.

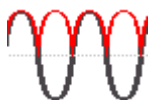

"S1²" *Square:* Squares the value of "Source 1".



Remote command:

[CALCulate:MATH\[:EXPRession\] \[:DEFine\]](#) on page 347

[RANGE] keys

The vertical [RANGE] keys set the vertical scale (vertical sensitivity) of the math waveform.

Remote command:

[CALCulate:MATH:VERTical:SCALE](#) on page 348

[CALCulate:MATH:VERTical:RANGE](#) on page 348

[POS] keys

Move the math waveform or down in the diagram. The position is a graphical setting given in divisions.

You can also drag the waveform marker on the screen.

Remote command:

[CALCulate:MATH:VERTical:POSition](#) on page 348

4.5 Reference Waveforms

To compare waveforms and analyze differences between waveforms, you can use a reference waveform. You can also save reference waveforms and load them for further use. The display of a reference waveform is independent from that of the source waveform; you can change the vertical scale and position



To create and save a reference waveform

1. Set up the waveform that will be the reference.
2. Open the "Ref" menu.
3. Select the "Source" waveform.
4. Select "Update".
The reference waveform is created, activated, and shown on top of the original waveform.
5. You can change the vertical scale and position using the [RANGE] and [POS] keys.
6. To save the reference, select "Save".
7. Select the "File Type" (format BIN, XML, or CSV).
8. Select the "File Name" and enter the file name.

4.5.1 Settings for Reference Waveforms

Access: "Ref" menu

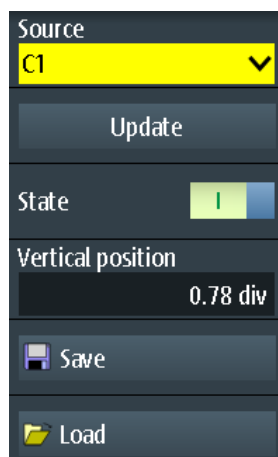

Source

Selects the waveform to be taken as reference waveform. Any active channel or math waveform can be used.

Remote command:

[REFCurve:SOURce](#) on page 348

Update

Creates the reference waveform from the source waveform.

Remote command:

[REFCurve:UPDate](#) on page 348

State

Activates the waveform and displays it.

Remote command:

`REFCurve:STATe` on page 349

`CALCulate:MATH:STATe` on page 347

Vertical Position

Sets the vertical position of the reference waveform.

You can also tap the waveform label "R" to set the focus to the reference waveform, and use the [RANGE] and [POS] keys to adjust the display.

Remote command:

`REFCurve:POSition` on page 349

Save/ Load

Saves or loads a reference waveform. The default directory is `C:/Users/<user>/Rohde-Schwarz/RTH/ReferenceCurves`.

Select the "File Type" (format BIN, XML, or CSV) and enter the "File Name". See also [Chapter 4.5.2, "Waveform Files"](#), on page 96.

Remote command:

`REFCurve:NAME` on page 349

`REFCurve:SAVE` on page 349

`REFCurve:OPEN` on page 349

`REFCurve:DELeTe` on page 349

4.5.2 Waveform Files

Reference waveforms can be stored in XML, CSV, or BIN format.



If you want to reload reference waveforms on the instrument, save them in BIN or CSV format. XML files cannot be reloaded.

Waveform data is saved in two files. One file contains the waveform data values and is indicated by `*Wfm.*` in the file name. The second file contains the header data, for example, time scale, vertical scale, vertical position, acquisition mode, and more. Header data is required to reload the waveform from data, or to analyze the data values of the data file.

4.5.2.1 Waveform Header Files

The header files of XML and BIN waveform files are written in XML format. The header files of CSV waveform files are written in CSV format. You can open the header files and use their information for data analysis.

CSV header files only contain the property names and values, one property per row.

```
VerticalScale:0.05:
```

```
HorizontalScale:5e-08:
```

XML header files contain more information than CSV header files. For analysis, only Name and Value are needed.

```
<Prop Name="VerticalScale" Value="0.05" UserValue="0.05" Step="0.001" Default="0.05"
Min="0.001" Max="100" StepDefault="0.001" StepFactor="10" UnitId="77"
UnitName="V/div" BitGroupSize="0" Format="0"></Prop>
<Prop Name="HorizontalScale" Value="1e-07" UserValue="1e-07" Step="1e-09"
Default="1e-07" Min="1e-09" Max="500" StepDefault="1e-09" StepFactor="10"
UnitId="75" UnitName="s/div" BitGroupSize="0" Format="0"></Prop>
```

Header files contain the following properties:

Value	Description
Vertical settings	
VerticalScale	Vertical scale of the waveform in Volts per division, or other unit / division
VerticalOffset	Vertical offset of the waveform in Volts, or other unit
VerticalPosition	Vertical position of the waveform in divisions
Horizontal and acquisition settings	
HorizontalScale	Time scale in seconds per division
HorizontalLeft	Horizontal start value of the waveform (time in s)
HorizontalResolutionPP	Time between two recorded samples
HorizontalAcquisitionMode	Sample, Peak Detect, High Res, Envelope, or Average
HorizontalDecimationFactor	At long time bases, if the number of captured samples is higher than the available record length, decimation takes effect. If the time scale is $\leq 5 \mu\text{s}/\text{div}$, the decimation factor is 1.
Samples	
HorizontalTraceLength	Record length, number of recorded waveform samples, which are stored in the memory
PostSettlingSamples	Number of additional samples after the end of the waveform record.
PreSettlingSamples	Number of additional samples before the beginning of waveform samples. They ensure that all measurements can be performed on the reloaded waveform that could be performed on the original waveform.

4.5.2.2 Waveform Data Files

The waveform data files are indicated by **Wfm.** in the file name. They contain the actual waveform data, the Y-values of the samples. Mostly, the Y-values are voltages: Y0; Y1; Y2; Y3; ...

Before and after the waveform data, the instrument writes some presettling and post-settling samples. The overall number of values in the data file is:

$$\text{ValuesNumber} = \text{PreSettlingSamples} + \text{HorizontalTraceLength} + \text{PostSettlingSamples}$$

For envelope waveforms, the number of values in the file doubles. Two Y-values for each sample are written, one for the upper and one for the lower envelope:

Ymin0; Ymax0; Ymin1; Ymax1; Ymin2; Ymax2; Ymin3; Ymax3;...

In peak detect acquisition mode, the number of values depends on the decimation factor. If the decimation factor is 1, one value per sample is written. At higher decimation factors, two values per sample are written.

In CSV files, the data values of one sample are written in one row. Envelope data, for example, looks like this:

```
-0.0125490196078431    -0.0619607843137255
-0.0133333333333333    -0.0627450980392157
-0.0149019607843137    -0.0650980392156863
```

XML files are easy to read:

```
<sample>
  <datamax>-0.012549</datamax>
  <datamin>-0.0619608</datamin>
</sample>
<sample>
  <datamax>-0.0133333</datamax>
  <datamin>-0.0627451</datamin>
</sample>
<sample>
  <datamax>-0.014902</datamax>
  <datamin>-0.065098</datamin>
</sample>
```

4.6 XY-Diagram

XY-diagrams combine the voltage or current levels of two input signals in one diagram. They use the level of a second signal as the x-axis, rather than a time base. This allows you to perform phase shift measurements, for example.



1. Press the [Mode] key.
2. Select "XY".
3. Make sure that the signals, the trigger, and the acquisition are set up correctly. The following menus are available in XY-mode:
 - "Vertical", see [Chapter 3.2, "Vertical Setup"](#), on page 41.
 - "Horizontal", see [Chapter 3.3, "Horizontal Setup"](#), on page 46.
 - "Trigger", see [Chapter 3.6, "Trigger"](#), on page 52.
 - "Acquire", see [Chapter 3.4, "Acquisition Control"](#), on page 48.

To analyze the signal in XY-mode, you can use cursor measurements. You can select vertical or horizontal cursors, couple the cursor lines or set them to screen. All other cursor settings are not relevant for measuring the XY-diagram.

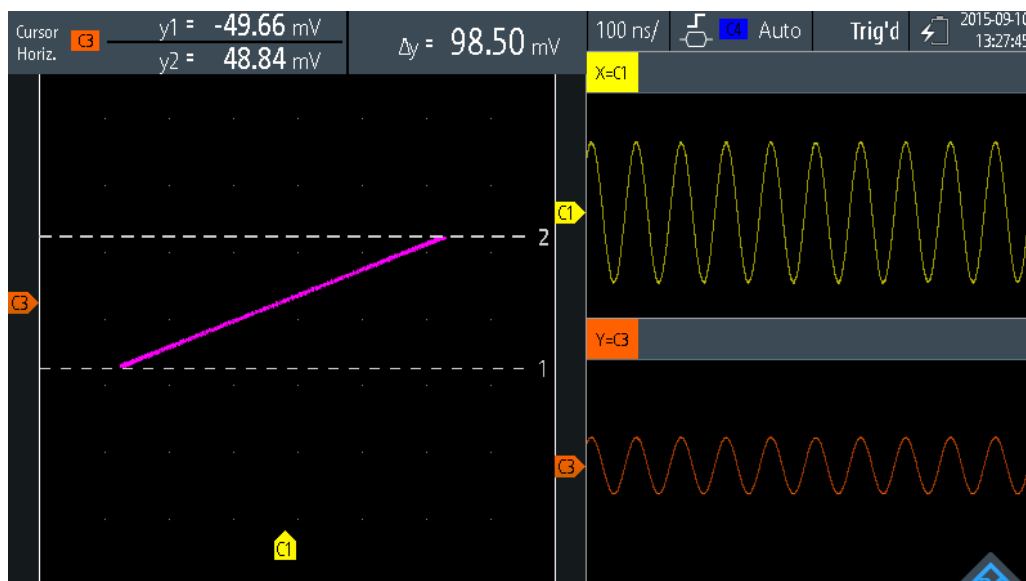

☰ Description of settings

Source X

Defines the signal that supplies the x-values of the XY-diagram, replacing the usual time base. The source can be any of the active analog channels.

Source Y

Defines the signal to be displayed in y-direction in an XY-diagram. The source can be any of the active analog channels.

4.7 History (Option R&S RTH-K15)

The history option R&S RTH-K15 accesses the data of previous acquisitions and provides them for further analysis. Using this option, you can analyze, for example, packet communication on serial buses, radar pulses, laser pulses, and signals that occur in short bursts with long idle times.

If history is enabled and an acquisition runs, the instrument stores the captured waveforms, processes the data and displays the current waveform. Each stored waveform is called a segment. When the acquisition is stopped, the history player is shown to access the stored segments, and to display and analyze them. When you start a new acquisition, the history is cleared and written anew.

The history stores the following data during acquisition:

- All active analog channels.
- All logic channels if at least one logic is active (with option R&S RTH-B1).
- Decoded bus data if the bus is active (with option R&S RTH-K1 and/or R&S RTH-K2).

To enable the history:

1. Tap the Menu button, and select "History" on the menu.
2. Enable "History".

4.7.1 History Settings

Access: "History" menu

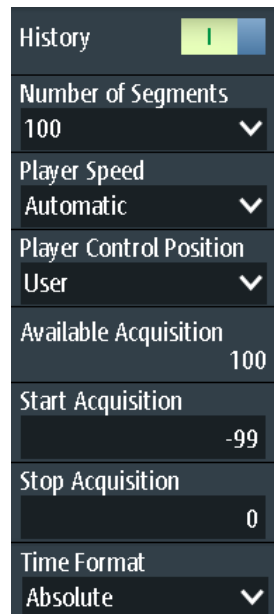
**History**

Enables the history function. The instrument stores the captured waveforms in segments. After stopping the acquisition, you can analyze them.

Remote command:

[CHANnel<m>:HISTory\[:STATe\]](#) on page 350

Number of Segments

Sets the number of segments to be stored.

Note: If zoom or mathematics are active during acquisition, the actual number of stored segments can be less than the defined number. To avoid the decrease of stored waveforms, disable zoom and mathematics before you acquire the waveforms. You can enable zoom and mathematics later in stop mode and use them to analyze any of the history segments.

Remote command:

[CHANnel<m>:HISTory:NSEGments](#) on page 350

Player Speed

Defines how fast the history player shows the stored segments.

Remote command:

[CHANnel<m>:HISTory:TPACq](#) on page 350

Player Control Position

Sets the position of the history player window on the display. You can drag the window on the touchscreen to another position. If so, a "User" position is indicated.

Available Acquisition

Shows the number of segments that are currently stored in the history.

Remote command:

[ACQUIRE:AVailable?](#) on page 350

Start Acquisition / Stop Acquisition

Define the index of the first and the last history segment that the history player shows. Change these values if you want to see a smaller range of subsequent segments from the history. The newest segment has always the index "0". Older segments have a negative index. The number of available segments is shown in "Available Acquisition".

Remote command:

[CHANnel<m>:HISTory:START](#) on page 351

[CHANnel<m>:HISTory:STOP](#) on page 351

Time Format

Defines if the timestamp in the history player window shows the absolute or relative time. Absolute time is the date and the daytime of the current acquisition. Relative time is the difference to the newest segment (index = 0).

See also "[Timestamp](#)" on page 102.

4.7.2 Displaying History Data

In the history player window, you start and stop the playback of the stored segments, and you can display a particular acquisition.

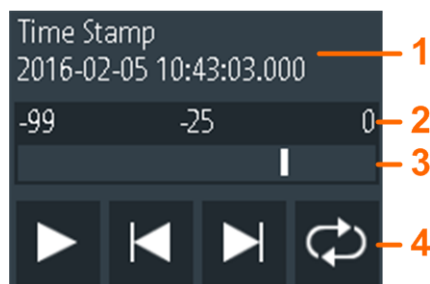

1 = Timestamp, here: absolute time

2 = Index of the oldest, current, and newest (= 0) segment

3 = Slider to set the displayed segment

4 = Control buttons: Play, Step Forward, Step Back, and Repeat

Timestamp

The timestamp shows the time of the currently displayed history segment. Thus, the time relation between acquisitions is always available. More precisely, the timestamp is the time of the trigger event.

The timestamp can be absolute or relative:

- Absolute: Date and daytime of the trigger event of the displayed segment, with an accuracy of 1 ms.
Depending on the horizontal position, the waveform can be captured up to 100,000 seconds after the trigger event, and thus after the displayed timestamp. The instrument considers this delay automatically, all measurements are related to the trigger event.
- Relative: time difference of the current segment to the newest segment (index = 0).

Remote command:

- [CHANnel<m>:HISTory:TSABsolute?](#) on page 352
- [CHANnel<m>:HISTory:TSDate?](#) on page 352
- [CHANnel<m>:HISTory:TSRelative?](#) on page 353

To display history segments

You can access the history segments in several ways:

- Play back all captured history segments.
- Play back a specified range of subsequent segments.
- Show one particular segment.

Proceed as follows:

1. If the acquisition is running, stop the acquisition.
The history player is shown.
2. To play back the segments once, tap the Play button.
By default, all captured waveforms are shown.
3. To display a range of segments out of the history:
 - a) Open the "History" menu.
 - b) Set the index of the first and the last segment that you want to see.
See ["Start Acquisition / Stop Acquisition"](#) on page 101.
 - c) In the history player window, tap the Play button.
4. To play back the segments repeatedly.
 - a) Enable the "Repeat" button.
 - b) Tap the "Play" button.
5. To access a particular segment, you can:
 - Drag the slider in the history player window until the required index number.
 - Use the "Step Forward" and "Step Back" buttons to show the next segment.

Remote command:

- `CHANnel<m>:HISTory:PLAY` on page 352
- `CHANnel<m>:HISTory:REPLay` on page 352
- `CHANnel<m>:HISTory:CURRent` on page 351

4.7.3 Analyzing History Data

You can analyze the stored segments using the following possibilities:

- Switch analog channels on and off if they were active during acquisition.
- Change vertical scale and position of captured channels.
- Use the zoom.
- Save screenshots.
- Use cursor measurements.
- Use automatic measurements.
- Use the mathematical functions.
- Switch logic channels on and off if at least one channel was active during acquisition.
- Enable and disable the serial bus if it was active during acquisition.

4.7.4 Exporting History Data

You can export history data to files. History data is always saved in "Compressed CSV" files. Each segment is saved to a separate file, and all segment files are written to a compressed folder.



Figure 4-5: Content of a history waveform folder

The filenames of the segment files are built using the filename pattern and the segment index: `<filename base>_<date>_<segment-timestamp>_<index>.csv`.

The filename of the ZIP file uses the same scheme and the timestamp of the oldest segment. Timestamps in filenames are always absolute time.

In the header section of the segment files, you find the absolute timestamp of the segment on the top. At the end, the relative timestamp of each segment is written, the time difference to the newest segment in s. The newest segment with index 0 has the relative timestamp 0.

```
Acquisition Time Stamp,2018-08-07 13:08:47.658371481,2018-08-07 13:08:47.658371481
Waveform Type,ANALOG,
Acquisition Mode,SAMPLE,
Horizontal Unit,s,
Horizontal Scale,1e-05,
Horizontal Position,0,
Reference Point,50 %,
Sample Interval,4e-10,
Record Length,250000,
Probe Setting,'10:1','10:1'
Vertical Unit,V,V
Vertical Scale,5,5
Vertical Position,2,-2
Vertical Offset,0,0
History Index,-98,-98
History Time Stamp,-0.518563990175,-0.518563990175
```

To save history data:

1. Set up the history and capture the waveforms.
2. Press the [FILE] key.
3. Select "Waveforms".
4. Select the waveforms for export:
 - a) Tap "Select Waveform".
 - b)
 - Select one waveform for export.
 - Or select all active waveforms.
5. Enable "Save History".

If an acquisition is running, enabling "Save History" stops the acquisition.
6. Check the "Directory", the "Filename Base", and the "CSV Column Delimiter".

Adjust if necessary.
7. If you need time information for analysis, enable "Store with Time".
8. Tap "Save Waveform".

All export settings are described in [Chapter 12.4.2, "Waveform Export Settings"](#), on page 274.

5 Mask Testing

Masks are used to determine whether the amplitude of a signal remains within specified limits, e.g. to detect errors or test compliance of digital signals.

A mask is specified by an upper and a lower limit line. The signal must run inside these limit lines, otherwise a mask violation occurs. A new mask is created from an existing signal: Mask limits are created by copying the waveform, and the limits are moved and stretched. The result is a tolerance tube around the signal that is used as mask.

5.1 Accessing the Mask Mode

1. Press the [MODE] key.

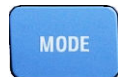

2. Select "Mask".

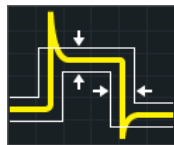

The mask interface is displayed and mask testing is started if masks are already defined and activated.

5.2 Mask Test Results

Mask testing checks all active waveforms for mask violation simultaneously.

The test result of the selected mask is shown in the result table in the upper left corner of the display.

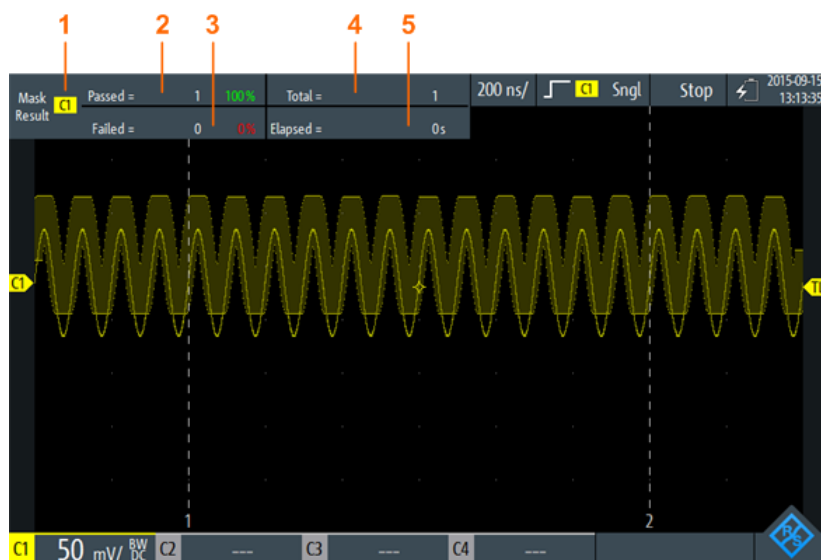

Figure 5-1: Mask-mode-view

- 1 = Selected channel
- 2 = Number and percentage share of passed acquisitions
- 3 = Number and percentage share of failed acquisitions
- 4 = Number of tested acquisitions
- 5 = Test duration

Remote commands for mask test results:

- [MASK:CHANnel<m>:RESult:PASS\[:COUNT\]? on page 356](#)
- [MASK:CHANnel<m>:RESult:PASS:PERCentage? on page 356](#)
- [MASK:CHANnel<m>:RESult:FAIL\[:COUNT\]? on page 355](#)
- [MASK:CHANnel<m>:RESult:FAIL:PERCentage? on page 355](#)
- [MASK:CHANnel<m>:RESult:TOTL\[:COUNT\]? on page 356](#)
- [MASK:ELAPsedtime:TOTAl? on page 356](#)
- [MASK:ELAPsedtime\[:SECS\]? on page 357](#)
- [MASK\[:TESTstate\]? on page 355](#)

5.3 Running Mask Tests

1. Before you can perform mask tests, adjust the waveforms by editing the vertical, horizontal, trigger and acquisition settings.

For details see:

- [Chapter 3.2, "Vertical Setup", on page 41](#)
- [Chapter 3.3, "Horizontal Setup", on page 46](#)
- [Chapter 3.6, "Trigger", on page 52](#)
- [Chapter 3.4, "Acquisition Control", on page 48](#)

Note: The acquisition mode "Envelope" is not available while running mask tests.

2. If you want to test a mathematical (math) waveform, generate a math waveform, see [Chapter 4.4, "Mathematics"](#), on page 92.
3. Select the "Mask" menu.
4. Select the mask channel that is assigned to the tested waveform.
5. To activate the mask, tap "State".

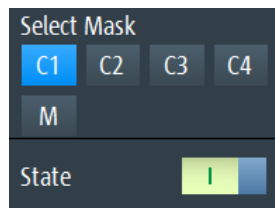

Note: If the selected mask was used before, the stored mask is displayed.

6. To set the mask width, enter "Width X" and "Width Y".
7. Select the "Action on Violation".
This action is applied to all masks.
8. To create the mask, tap "Create Mask".
9. To start and stop mask testing, press the [RUN STOP] key.



Analyzing the mask test

To view the details of the waveform at a mask test violation, you can use the zoom function, see [Chapter 4.1, "Zoom"](#), on page 79. Zooming is only possible while the mask test is stopped.

5.4 Mask Settings

Access: "Mask" menu

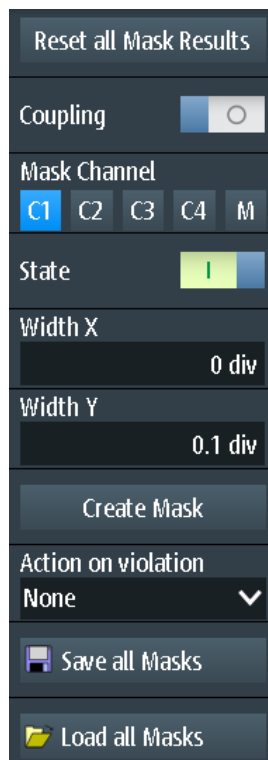

Figure 5-2: Mask settings

Reset all Mask Results

Resets all mask test results.

Remote command:

[MASK:RST](#) on page 355

Coupling

If enabled, the settings of the selected mask are applied to all active masks when you tap "Create Mask".

Mask Channel

Selects the mask to be configured.

If the selected mask has been created before, and it is active, the mask is shown on the display.

Each mask channel is assigned to its related waveform (input channel or math waveform) as indicated by the mask channel name.

State

Turns the mask on or off.

If the assigned waveform is inactive, it is activated together with the mask.

Remote command:

[MASK:CHANnel<m>:STATe](#) on page 353

Width X

Changes the width of the mask in horizontal direction.

The specified number of divisions is added to the positive x-values and subtracted from the negative x-values of the mask limits in relation to the mask center. Thus, the left half of the mask is pulled to the left, the right half is pulled to the right.

To apply the changed value to an existing mask, tap "Create Mask".

Remote command:

[MASK:CHANnel<m>:PROPerties:XWIDth](#) on page 353

Width Y

Changes the width of the mask in vertical direction.

The specified number of divisions is added to the y-values of the upper mask limit and subtracted from the y-values of the lower mask limit. Thus, the upper half of the mask is pulled upwards, the lower half is pulled down, and the overall height of the mask is twice the "Width Y".

To apply the changed value to an existing mask, tap "Create Mask".

Remote command:

[MASK:CHANnel<m>:PROPerties:YWIDth](#) on page 354

Create Mask

Creates a new mask, or applies modified mask settings to the mask.

If "Coupling" is enabled, all active masks are recreated with the settings of the selected mask.

Remote command:

[MASK:CHANnel<m>:CREatemask](#) on page 354

Action on Violation

Selects the action to be executed if the mask limits are violated.

This action is applied to all masks.

Remote command:

[MASK:ONViolation\[:SELECTION\]](#) on page 354

Save all Masks

Opens an explorer to save all active masks.

Load all Masks

Opens an explorer to load masks.

If an acquisition is running, the acquisition is topped until the masks are reloaded.

[RUN] / [STOP]

Starts and stops triggering on mask violations.

Remote command:

[RUN](#) on page 311

[STOP](#) on page 311

6 Spectrum Analysis

The R&S RTH provides several forms of spectrum analysis:

- Basic FFT calculation, which is included in the firmware
 - Spectrum analysis option R&S RTH-K18, which provides a wide range of analysis possibilities, for example, peak search and cursor measurements.
 - Harmonics measurement option R&S RTH-K34, which provides an overview and characteristic details on the harmonics contained in the measured signal
- | | |
|--|-----|
| • FFT Mode | 110 |
| • Spectrum Mode (Option R&S RTH-K18) | 117 |
| • Harmonics Measurement (Option R&S RTH-K34) | 134 |

6.1 FFT Mode

The new FFT mode is included in the standard R&S RTH installation and allows you to perform FFT analysis directly on the instrument. During FFT analysis, the captured signal in the time domain is converted to a spectrum of frequencies. As a result, the magnitude of the determined frequencies can be displayed.

6.1.1 Accessing the FFT Mode

1. Press the [MODE] key.

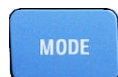

2. Select "FFT".



A power vs. frequency (spectrum) diagram is displayed, and the spectrum of the currently captured data is analyzed, if available.

6.1.2 Display and Control

The FFT display shows a power vs. frequency (spectrum) diagram and relevant analysis parameters. FFT results are useful to obtain an overview of the input signal in the frequency domain and to detect unusual signal effects (such as spurs or distortions) visually.

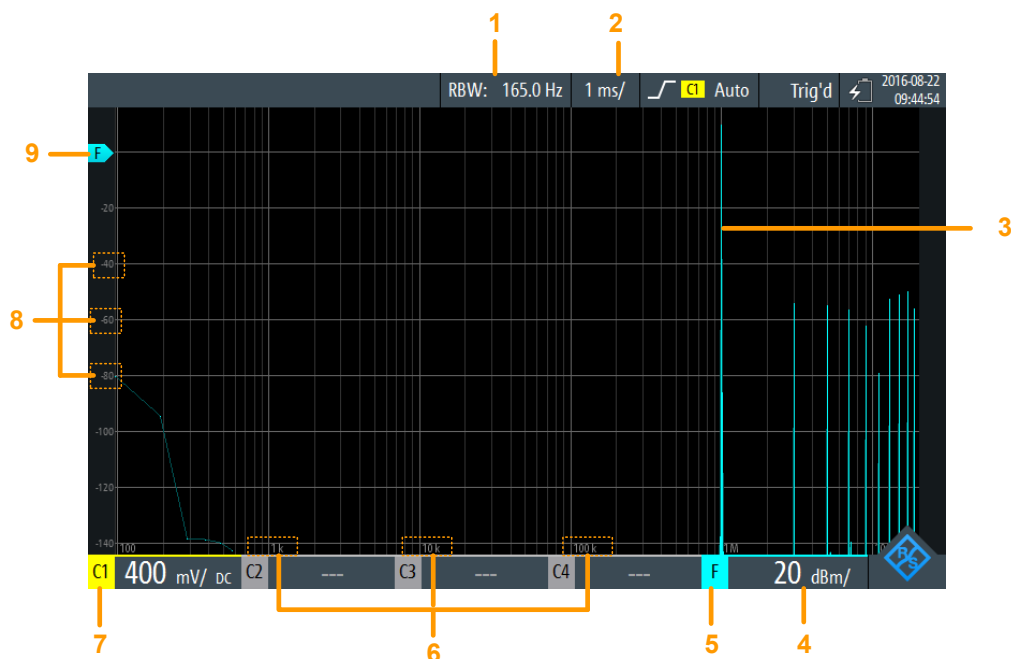

Figure 6-1: FFT display

- 1 = Resolution bandwidth (RBW), determined from channel bandwidth and frequency span
- 2 = Time scale (time per division)
- 3 = Power vs. time waveform
- 4 = Amplitude (y-axis) scale (range per division)
- 5 = FFT mode active
- 6 = Frequency values (x-axis)
- 7 = Channel providing input data
- 8 = Amplitude values (y-axis)
- 9 = 0 dBm line (y-axis)

Data source

FFT analysis is performed on the data captured from one of the active input channels. Analysis can be performed on all channels simultaneously.

Time base

FFT analysis is generally performed on the data captured during the entire data acquisition. To restrict the time base for which FFT analysis is to be performed (thus reducing calculation time), you must change the [Time Scale](#). Gating or zooming is not available for FFT analysis.

Frequency range

The spectrum display can also be restricted to a specified frequency range. By default, the full determined spectrum is displayed. However, you can restrict the channel bandwidth to a smaller value.



Aliasing

In FFT mode, no lowpass filter is applied. If aliasing occurs, try restricting the frequency range of the input signal using the [Channel Bandwidth](#) setting.

Note that, as opposed to FFT mode, the Spectrum mode (option R&S RTH-B18) uses an anti-aliasing filter.

The frequency axis is adjusted to the available spectrum and the selected [X-Scaling](#) mode (linear or logarithmic). For linear scaling, the frequency axis starts at 0 Hz.

For logarithmic scaling, it starts at the frequency resolution (the distance between two individual frequency values on the x-axis), which depends on the selected [Frequency Span](#) and the [Channel Bandwidth](#).



In logarithmic mode, not all possible amplitude values for a specific frequency may occur. Each result is indicated by a bright, colored trace point.

The DC amplitude (at 0 Hz) is not displayed, as $\lg(0)$ is not defined.

The maximum frequency value depends on the following parameters and is adjusted accordingly:

- [Sample Frequency](#) (the sample rate with which FFT analysis is performed)
- [Channel Bandwidth](#)
- Installed bandwidth options

Amplitude range

The amplitudes determined for each frequency are displayed on the y-axis of the spectrum. The values are scaled in dBm (dBmW) based on 50 Ω impedance.

To change the displayed range, use the [\[RANGE\] keys](#) and the [\[POS\] keys](#). The position of the 0 dBm line is indicated by an "F" on the y-axis.



AUTOSET, vertical, and trigger settings

Vertical and trigger settings for the input signal must be applied in Scope mode, before FFT mode is selected. The same applies to automatic adjustment of the instrument settings to the input signal ([AUTOSET]).

6.1.3 Performing FFT Analysis

1. Before you can perform FFT analysis, adjust the waveforms by editing the vertical, horizontal, trigger and acquisition settings.

For details, see:

- [Chapter 3.2, "Vertical Setup"](#), on page 41
- [Chapter 3.3, "Horizontal Setup"](#), on page 46
- [Chapter 3.6, "Trigger"](#), on page 52

- [Chapter 3.4, "Acquisition Control"](#), on page 48
2. To adjust the instrument settings to the current input signal automatically, press [AUTOSET].
 3. Select the "FFT" mode.
 4. Select the "Frequency Span" setting and determine which sample frequency you require ("Max" is the highest).
 5. Select the "Window" type according to the signal characteristics that are most relevant for your measurement task (see ["Window type"](#) on page 114).
 6. Select the "Channel Bandwidth" setting and define the frequency limit of the spectrum diagram. Frequencies above the selected limit are removed to reduce noise at different levels.
 7. To switch to a logarithmic frequency scaling, select "X-Scaling": "Logarithmic".
 8. To start and stop FFT analysis, press the [RUN STOP] key.



6.1.4 FFT Mode Settings

Access: "FFT" menu



Additional settings for horizontal (time) scaling and data acquisition are available for FFT mode and directly accessible via the FFT menu. For a description, see:

- ["Time Scale"](#) on page 47
- ["Acquisition Mode"](#) on page 49
- ["Sampling Rate C1 - C4"](#) on page 50

Furthermore, the history function can be used to perform FFT analysis on stored data, see [Chapter 4.7, "History \(Option R&S RTH-K15\)"](#), on page 99.

[CH <n>]	113
Frequency Span	114
Window type	114
Channel Bandwidth	115
X-Scaling	115
Sample Frequency	115



[CH <n>]

Selects the channel for which the captured data is analyzed in FFT mode. FFT analysis can be performed on all channels simultaneously.

Remote command:

[SPECTrum: SOURce](#) on page 357

Frequency Span

Determines how many values are analyzed by a single FFT (sample frequency), and thus the frequency resolution. The larger the value, the higher the resolution, but the longer the required analysis time.

Note: Due to the longer analysis time, changes to the measurement settings may only become visible with a time delay.

Furthermore, the frequency span determines the visible range in the spectrum diagram. Depending on the selected frequency span, the time scale may be restricted (see "Time Scale" on page 47).

"Narrow" 8k values analyzed per FFT; time scale ≥ 100 ms/div

"Max" 64k values analyzed per FFT; time scale ≥ 1 μs/div

Remote command:

[SPECTrum:FREQuency:SPAN:MODE](#) on page 359

[SPECTrum:FREQuency:SPAN\[:VALue\]](#) on page 359

[SPECTrum:FREQuency:CENTer](#) on page 358

[SPECTrum:FREQuency:STARt](#) on page 359

[SPECTrum:FREQuency:STOP](#) on page 360

[SPECTrum:FREQuency:BANDwidth\[:RESolution\]\[:VALue\]](#) on page 358

Window type

Windowing helps minimize the discontinuities at the end of the measured signal interval and thus reduces the effect of spectral leakage, increasing the frequency resolution.

Various different window functions are provided in the R&S RTH to suit different input signals. Each of the window functions has specific characteristics, including some advantages and some trade-offs. Consider these characteristics carefully to find the optimum solution for the measurement task.

Table 6-1: Window type characteristics

Window type	Frequency resolution	Magnitude resolution	Measurement recommendation
Rectangular	Best	Worst	Separation of two tones with almost equal amplitudes and a small frequency distance
Hamming Hann	Good	Poor	Frequency response measurements, sine waves, periodic signals and narrow-band noise
Flat-Top	Poor	Best	Accurate single-tone measurements
Blackman	Worst	Best	Mainly for signals with single frequencies to detect harmonics Accurate single-tone measurements

Remote command:

[SPECTrum:FREQuency:WINDow:TYPE](#) on page 360

[SPECTrum:FREQuency:WINDow:FACTor?](#) on page 360

Channel Bandwidth

Determines the frequency limit of the spectrum. Frequencies above the selected limit are removed to reduce noise at different levels. Values from 1 kHz to 10 MHz can be selected. Alternatively, the full span of the current input signal can be selected.

For more details on the channel bandwidth, see ["Bandwidth"](#) on page 43.

Remote command:

[CHANnel<m>:BANDwidth](#) on page 308

X-Scaling

Defines the scaling method for the frequency (x-)axis of the spectrum display.

"Linear" Linear scaling

"Logarithmic" Logarithmic scaling

Note that in this mode, not all possible amplitude values for a specific frequency may occur. Each result is indicated by a bright, colored trace point.

The DC amplitude (at 0 Hz) is not displayed, as $\lg(0)$ is not defined.

Remote command:

[SPECTrum:FREQUENCY:HORizontal:SCALE](#) on page 358

Sample Frequency

Indicates the sample rate with which FFT analysis is performed. This value may differ from the [Sampling Rate C1 - C4](#) in the data acquisition settings, as the number of samples must be adjusted to a value of 2^x FFT points.

Remote command:

[SPECTrum:FREQUENCY:SAMPLE?](#) on page 359

6.1.5 Export FFT Data to File

Access: [MODE] = "FFT" > [FILE] > "FFT"



The results of a spectrum measurement can be exported similarly to a waveform (see also [Chapter 12, "Documenting Results"](#), on page 268). The OneTouch functionality is also available (see [Chapter 12.6, "Quick Save with OneTouch"](#), on page 280).

File Format

Selects the format of the export file. For details on the file format, see [Chapter 6.1.6, "Export File Format for FFT Results"](#), on page 117.

"CSV"	Comma-separated values (CSV) text file, the waveform is stored in a table. The columns are separated by commas or another delimiter. For each sample, one line is written. Values are listed in scientific notation. You can convert the comma-separated text to columns.
"Compressed CSV"	ZIP file that contains one or more CSV files. This format reduces the file size.

Remote command:

`SPECTrum:EXPort:NAME` on page 371

Save Spectrum, Save Spectrum As

Save the spectrum results.

"Save"	Saves the file in the defined "Directory" using the autonaming pattern.
"Save As"	Opens a file explorer where you can select the directory and enter the filename.

Remote command:

`SPECTrum:EXPort:SAVE` on page 371

Directory

Defines the directory where the spectrum files are stored. If a USB flash drive is connected, the instrument stores the data to this external device by default.

Remote command:

`SPECTrum:EXPort:NAME` on page 371

Filename Base

Defines the first part of the filename. The complete filename pattern is:

`<filename base>_<date>_<timestamp>.csv.`

Remote command:

`SPECTrum:EXPort:NAME` on page 371

Store with Freq.

Includes the frequency values in the stored results.

Remote command:

`SPECTrum:EXPort:INCXvalues` on page 371

CSV Column Delimiter

Selects the column delimiter for CSV files. You need to know the delimiter when you convert the CSV text to columns in a spreadsheet.

6.1.6 Export File Format for FFT Results

The file format for FFT results is similar to a waveform export file; it is also stored in CSV format. You can convert the comma-separated text to columns (see [Chapter 12.4.3.3, "Converting CSV to Excel Files"](#), on page 279).

Table 6-2: Header data (converted to table)

Spectrum Results	[Example data]
Model	RTH1004
SerialNumber	xxxxx
Firmware Version	'1.60'
Acquisition Time Stamp	2017-07-31 14:27:35.96278902
Center Frequency [Hz]	2.5e+008
Span [Hz]	5e+008
RBW [Hz]	2.5e+006
Window	Hann
Record Length [n]	6554
Start Frequency [Hz]	0
Frequency Resolution [Hz]	76293.9

Table 6-3: Spectrum (trace) data (converted to table data)

Frequency	Magnitude
[Hz]	[V]/[A] ^{*)}
0	0.000113039
76293.9	0.000226932
...	
*) depends on probe setting	

6.2 Spectrum Mode (Option R&S RTH-K18)

The optional Spectrum mode allows you to perform sophisticated spectrum analysis directly on the instrument. During spectrum analysis, the captured signal in the time domain is converted to a spectrum of frequencies. As a result, various signal characteristics in the frequency domain can be displayed.

- [Accessing the Spectrum Mode](#)..... 118
- [Display and Control](#)..... 118
- [Performing Spectrum Analysis](#)..... 120
- [Spectrum Mode Settings](#)..... 121
- [Vertical Settings](#)..... 125

- [Marker \(Peak Search\) Settings](#)..... 126
- [Cursor Measurements on Spectrums](#)..... 129
- [Export Spectrum Data to File](#)..... 132
- [Export File Format for Spectrum Results](#)..... 133

6.2.1 Accessing the Spectrum Mode

1. Press the [MODE] key.

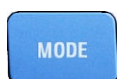

2. Select "Spectrum".

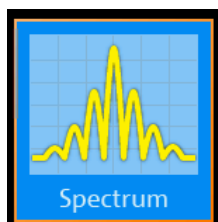

A power vs frequency (spectrum) diagram is displayed, and the spectrum of the currently captured data is analyzed, if available.

6.2.2 Display and Control

The Spectrum display shows a power vs frequency (spectrum) diagram and relevant analysis parameters. Spectrum results are useful to obtain an overview of the input signal in the frequency domain and to detect unusual signal effects (such as spurs or distortions) visually.

The power levels in the diagram are always scaled logarithmically. The frequency axis can be displayed either logarithmically or linearly.

Various statistical evaluations can be performed and displayed simultaneously. In this case, the different traces are displayed in different colors:

- Currently calculated spectrum: cyan-colored trace (like basic FFT)
- Min hold and max hold evaluation: blue trace
- Averaged spectrum: magenta-colored trace

Optionally, markers can be activated to indicate peak values in the spectrum. Track cursors are available to determine the power or power density in a specific frequency range.

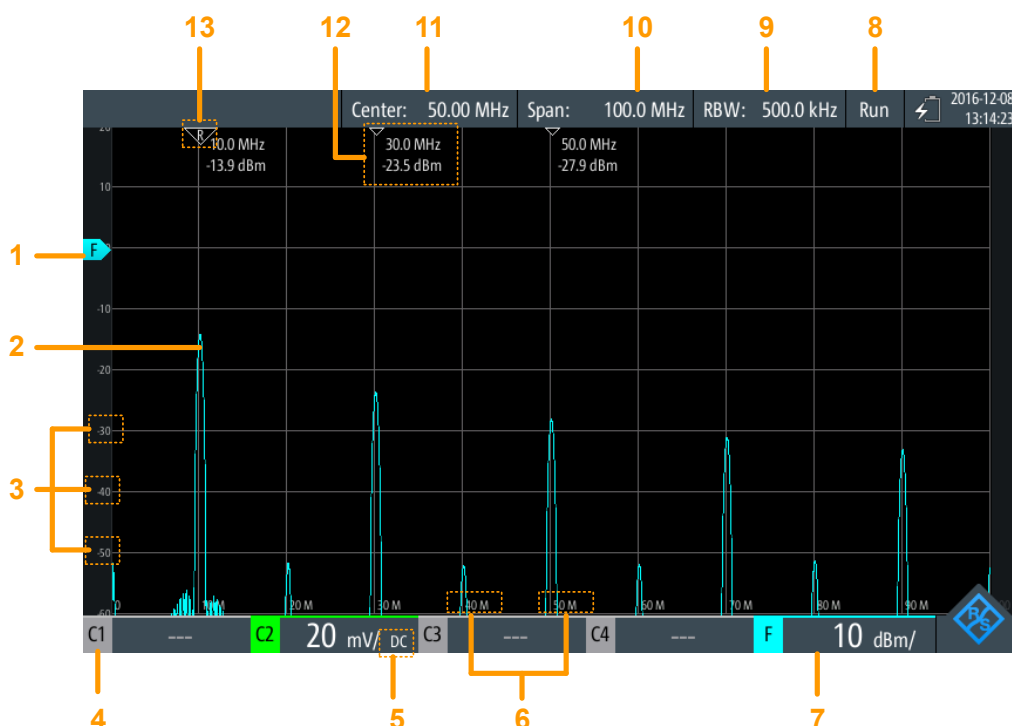

Figure 6-2: Spectrum display

- 1 = Reference level (y-axis, by default 0 dBm line)
- 2 = Currently calculated spectrum (power vs. frequency graph)
- 3 = Amplitude scale (y-axis)
- 4 = Channel providing input data
- 5 = Coupling of the input channel
- 6 = Frequency scale (x-axis)
- 7 = Amplitude scale (y-axis, power per division)
- 8 = Operating status of the spectrum measurement ("Hold"/"Run")
- 9 = Displayed resolution bandwidth
- 10 = Displayed frequency span
- 11 = Center frequency
- 12 = Marker results
- 13 = Reference marker

Data source

Spectrum analysis is performed on the data captured from one of the active input channels. Analysis can only be performed on one channel at a time.

Time base and resolution bandwidth

Spectrum analysis is generally performed on the data captured during the entire data acquisition. To restrict the time base for which spectrum analysis is to be performed (thus reducing calculation time), you must increase the resolution bandwidth (RBW, see "[Resolution bandwidth \(RBW\)](#)" on page 123). Gating or zooming is not available for spectrum analysis.

Frequency range

The spectrum display can also be restricted to a specified frequency range.

The frequency axis is adjusted to the available spectrum and the selected [X-Scaling](#) mode (linear or logarithmic). Note that changing the frequency range only affects the spectrum display, not the calculated results.



In logarithmic mode, not all possible amplitude values for a specific frequency may occur. Each result is indicated by a bright, colored trace point.

The DC amplitude (at 0 Hz) is not displayed, as $\lg(0)$ is not defined.

Amplitude range

The amplitudes determined for each frequency are displayed on the y-axis of the spectrum. The values are scaled in dBm (dBmW) based on 50 Ω impedance.

To change the displayed range, use the [\[RANGE\] keys](#) and the [\[POS\] keys](#). The position of the 0 dBm line is indicated by an "F" on the y-axis.

Triggering

During spectrum analysis, no triggering is used - the trigger settings are ignored. A spectrum is calculated from the input data continuously.

6.2.3 Performing Spectrum Analysis

1. Before you perform spectrum analysis, adjust the instrument settings to the input signal by editing the vertical, horizontal, and acquisition settings.

For details, see:

- [Chapter 3.2, "Vertical Setup"](#), on page 41
- [Chapter 3.3, "Horizontal Setup"](#), on page 46
- [Chapter 3.4, "Acquisition Control"](#), on page 48

2. To adjust the instrument settings to the current input signal automatically, press [AUTOSET].
3. Select the "Spectrum" mode.
4. Define the "Center Frequency" for analysis.
5. Define the "Span" of the spectrum to be analyzed.
6. Define the required "RBW: Span Ratio" according to your test requirements.
7. Select the "Window" type according to the signal characteristics that are most relevant for your measurement task (see ["Window type"](#) on page 114).
8. To switch to a logarithmic frequency scaling, select "X-Scaling": "Logarithmic".

9. To perform statistical evaluation of the spectrum results, select one of the evaluation modes.

For averaging, define the number of values to be considered.

10. Select the "Vertical" menu.

11. Define the unit in which the magnitude values are indicated.

12. Define the "Reference Level" as the highest expected input level.

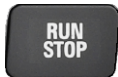

13. To start and stop spectrum analysis, press the [RUN STOP] key.

14. To determine peaks in the spectrum:

- a) Select the "Marker" menu.
- b) Set the "State" to "On" to enable a peak search.
- c) Define the number of markers as the maximum number of peaks to be detected.
- d) Define the "Threshold", "Excursion", and "Distance" to configure the peak search.
- e) Select one of the displayed traces to be used as the source of the peak search.
- f) Select whether the marker values are indicated as absolute values or relative to the reference (highest) peak.

15. To determine the frequency or level values, or both, at specific points in the spectrum, enable the spectrum track cursors:

- a) Select the "Cursor" menu.
- b) Set the "State" to "On" to display the cursors.
- c) Select one of the displayed traces to be used as the source of the track cursors.
- d) Select whether the values are indicated as absolute values or as the difference between the two cursors ("Delta").
- e) Drag the cursors to the required positions in the spectrum.
The levels and frequencies of the cursors at the crossings with the spectrum are indicated at the top of the diagram.
- f) To keep the cursors at a fixed distance to one another, enable the "Coupling" option.
- g) To keep the cursors at a fixed (relative) distance to the spectrum, regardless of the current scaling, enable the "Track Scaling" option.

6.2.4 Spectrum Mode Settings

Access: "Spectrum" menu

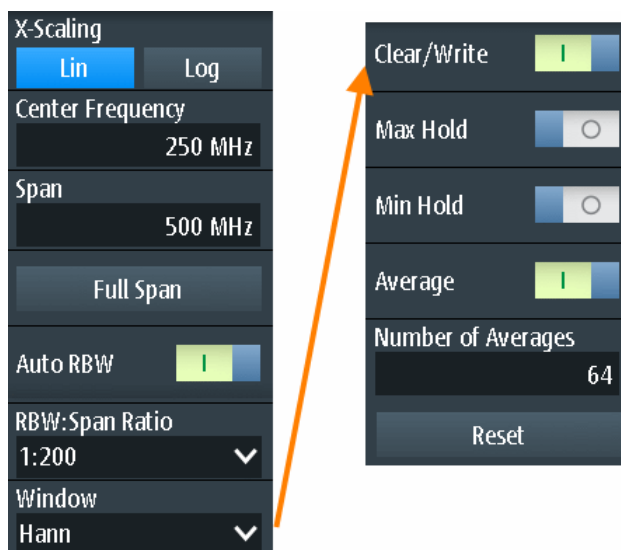

Additional settings for horizontal (frequency) scaling and data acquisition are available for Spectrum mode and directly accessible via the "Spectrum" menu. For a description, see:

- "Time Scale" on page 47
- "Acquisition Mode" on page 49
- "Sampling Rate C1 - C4" on page 50

X-Scaling.....	122
Center Frequency.....	123
Span.....	123
Start Frequency/ Stop Frequency.....	123
Resolution bandwidth (RBW).....	123
Window type.....	124
Trace mode (Clear/Write/ Max Hold/ Min Hold/Average).....	124
Reset.....	125

X-Scaling

Defines the scaling method for the frequency (x-)axis of the spectrum display.

- "Linear" Linear scaling
- "Logarithmic" Logarithmic scaling
 Note that in this mode, not all possible amplitude values for a specific frequency may occur. Each result is indicated by a bright, colored trace point.
 The DC amplitude (at 0 Hz) is not displayed, as lg(0) is not defined.

Remote command:

SPECTrum:FREQUency:HORizontal:SCALE on page 358

Center Frequency

Defines the frequency in the center of the displayed span for linear frequency scaling (see "X-Scaling" on page 115). Usually, the center frequency is set to the highest measured power level in spectrum analysis.

To set the center frequency, you can also use the [POS] keys.

Remote command:

`SPECTrum:FREQuency:CENTer` on page 358

Span

Determines the measured frequencies and the visible range in the spectrum diagram for linear frequency scaling (see "X-Scaling" on page 115). Depending on the selected span, the time scale may be restricted (see "Time Scale" on page 47).

To set the span, you can also use the [TIME] keys.

The span must be within the range 1 kHz to 500 MHz.

Note that this range only affects the displayed spectrum, not the calculated results.

Remote command:

`SPECTrum:FREQuency:SPAN[:VALue]` on page 359

Start Frequency/ Stop Frequency

For logarithmic frequency scaling (see "X-Scaling" on page 115), the displayed frequency range is defined by a start and a stop value, rather than a span and center frequency. Note that this range only affects the displayed spectrum, not the calculated results.

Remote command:

`SPECTrum:FREQuency:START` on page 359

`SPECTrum:FREQuency:STOP` on page 360

Resolution bandwidth (RBW)

The resolution bandwidth (RBW) determines the resolution of the spectrum, that is: the minimum distance between two distinguishable peaks. The higher the resolution (the smaller the ratio), the more peaks are detected, but the longer the measurement requires to finish.

In manual operation, the RBW is defined in relation to the selected frequency span and must lie between 1:1000 and 1:10. If you change the span, the RBW is automatically adjusted to the minimum or maximum allowed value, if necessary. (In remote operation, the RBW can also be defined directly, independently of the span).

In Auto mode, the optimal resolution according to the frequency **Span** and selected **Window type** is used. It is indicated for the "RBW" setting.

Remote command:

`SPECTrum:FREQuency:BANDwidth[:RESolution]:AUTO` on page 362

`SPECTrum:FREQuency:BANDwidth[:RESolution]:RATio` on page 362

`SPECTrum:FREQuency:BANDwidth[:RESolution][:VALue]` on page 358

Window type

Windowing helps minimize the discontinuities at the end of the measured signal interval and thus reduces the effect of spectral leakage, increasing the frequency resolution.

Various different window functions are provided in the R&S RTH to suit different input signals. Each of the window functions has specific characteristics, including some advantages and some trade-offs. Consider these characteristics carefully to find the optimum solution for the measurement task.

Table 6-4: Window type characteristics

Window type	Frequency resolution	Magnitude resolution	Measurement recommendation
Rectangular	Best	Worst	Separation of two tones with almost equal amplitudes and a small frequency distance
Hamming Hann	Good	Poor	Frequency response measurements, sine waves, periodic signals and narrow-band noise
Flat-Top	Poor	Best	Accurate single-tone measurements
Blackman	Worst	Best	Mainly for signals with single frequencies to detect harmonics Accurate single-tone measurements

Remote command:

[SPECTrum:FREQUENCY:WINDow:TYPE](#) on page 360

[SPECTrum:FREQUENCY:WINDow:FACTOR?](#) on page 360

Trace mode (Clear/Write/ Max Hold/ Min Hold/Average)

Determines which of the acquired data is displayed. Several traces can be displayed in parallel, but at least one mode must be selected. By default, the "Clear/Write" mode is selected.

As soon as a new mode is selected, statistical evaluation is restarted.

To clear the results for previous measurements used for statistical evaluation, select [Reset](#).

"Clear/Write"	The currently measured value for each frequency is displayed.
"Max Hold"	The maximum value for each frequency over all measurements is displayed. Using the max hold trace mode is a good way to detect intermittent signals or the maximum values of fluctuating signals, for example.
"Min Hold"	The minimum value for each frequency over all measurements is displayed. Using the min hold trace mode is a good way to highlight signals within noise or suppress intermittent signals.
"Average"	The average value for each frequency in the Clear/write trace over the specified "Number of Averages" is calculated. Averaging reduces the effects of noise, but has no effects on sine signals. Using the trace averaging therefore is a good way to detect signals in the vicinity of noise.

Remote command:

`SPECTrum:WAVEform:MAXimum[:ENABLE]` on page 364

`SPECTrum:WAVEform:MINimum[:ENABLE]` on page 364

`SPECTrum:WAVEform:SPECTrum[:ENABLE]` on page 364

`SPECTrum:WAVEform:AVERage[:ENABLE]` on page 363

`SPECTrum:FREQUENCY:AVERage:COUNT` on page 361

Reset

Clears the results for previous measurements used in statistical evaluation (see [Trace mode \(Clear/Write/ Max Hold/ Min Hold/Average \)](#)).

Remote command:

`SPECTrum:FREQUENCY:RESet` on page 364

6.2.5 Vertical Settings

You can configure the vertical settings for the input signal in Scope mode. When you select the Spectrum mode, the configuration is maintained. Some additional vertical settings are available in Spectrum mode.

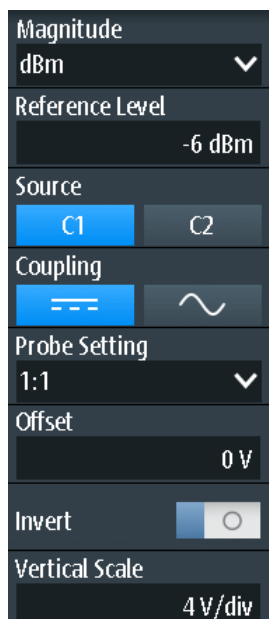

The [AUTOSSET] function sets the center frequency to the frequency with the highest measured power. All other vertical settings are set to allow for an optimal spectrum display.

The following vertical settings are identical to Scope mode:

- "Coupling" on page 42
- "Probe Setting" on page 43
- "Offset" on page 44
- "Invert" on page 44

The following settings are available in Spectrum mode only:

Unit of Magnitude..... 126
 Reference Level..... 126
 Source..... 126
 Vertical Scale..... 126

Unit of Magnitude

Defines the unit in which the power values are displayed.

Remote command:

`SPECTrum:FREQuency:MAGNitude:SCALe` on page 358

Reference Level

Defines the expected maximum input signal level.

Remote command:

`SPECTrum:FREQuency:MAGNitude:REFerence[:VALue]` on page 362



Source

Selects the channel for which the captured data is analyzed. Spectrum analysis can only be performed on one channel at a time.

The source can also be selected using the [CH1]/[CH2] keys.

Remote command:

`SPECTrum:SOURce` on page 357

Vertical Scale

Defines the scaling of the input signal in Volt per division.

Vertical scale and vertical position affect the resolution of the waveform amplitude directly. To get the full resolution, make sure that the waveforms cover most of the screen's height.

Note: This value configures the input signal. The vertical scale of the y-axis of the spectrum, which is indicated in the channel settings beneath the spectrum diagram, must be configured using the [RANGE] and [POS] keys.

6.2.6 Marker (Peak Search) Settings

Access: "Marker" menu



You can configure which peaks the instrument will find within the spectrum results. Peaks are indicated by markers in the power vs frequency display. The frequency and power level measured at the peak is also indicated in the diagram.



Overlapping markers

If two detected peaks are very close to each other and the markers in the display overlap, the marker with the lower amplitude is indicated in a darker color and put slightly in the background, while the one with the higher amplitude is displayed normally. Using the remote commands, both values can be retrieved.

Remote commands for results:

`SPECTrum:MARKer:RESult<m>:FREQuency[:VALue]?` on page 369

`SPECTrum:MARKer:RESult<m>:FREQuency:DELTA?` on page 369

`SPECTrum:MARKer:RESult<m>:LEVel[:VALue]?` on page 370

`SPECTrum:MARKer:RESult<m>:LEVel:DELTA?` on page 370

`SPECTrum:MARKer:RMARker:FREQuency?` on page 370

`SPECTrum:MARKer:RMARker:VALue?` on page 371

State.....	128
Number of Markers.....	128
Threshold.....	128
Peak excursion.....	128
Distance.....	129
Trace Source.....	129
Marker Value.....	129

State

If enabled, a peak search is performed on the current spectrum results and the specified **Number of Markers** are displayed.

Remote command:

`SPECTrum:MARKer[:STATe]` on page 367

Number of Markers

Defines the maximum number of markers used to indicate peaks in the spectrum results. With 3 active markers, the 3 peak values in the spectrum are indicated. Note that if fewer peaks are detected than the specified maximum number of markers, fewer markers are displayed.

Remote command:

`SPECTrum:MARKer:COUNT` on page 367

`SPECTrum:MARKer:RCOUNT?` on page 369

Threshold

Defines an absolute level threshold as an additional condition for the peak search. Only peaks that exceed the threshold are detected.

Remote command:

`SPECTrum:MARKer:SETup:MLEVel` on page 368

Peak excursion

Defines a relative threshold, the minimum level value by which the waveform must rise or fall to be considered a peak. To avoid identifying noise peaks, enter a peak excursion value that is higher than the noise levels.

The following figure shows a spectrum display:

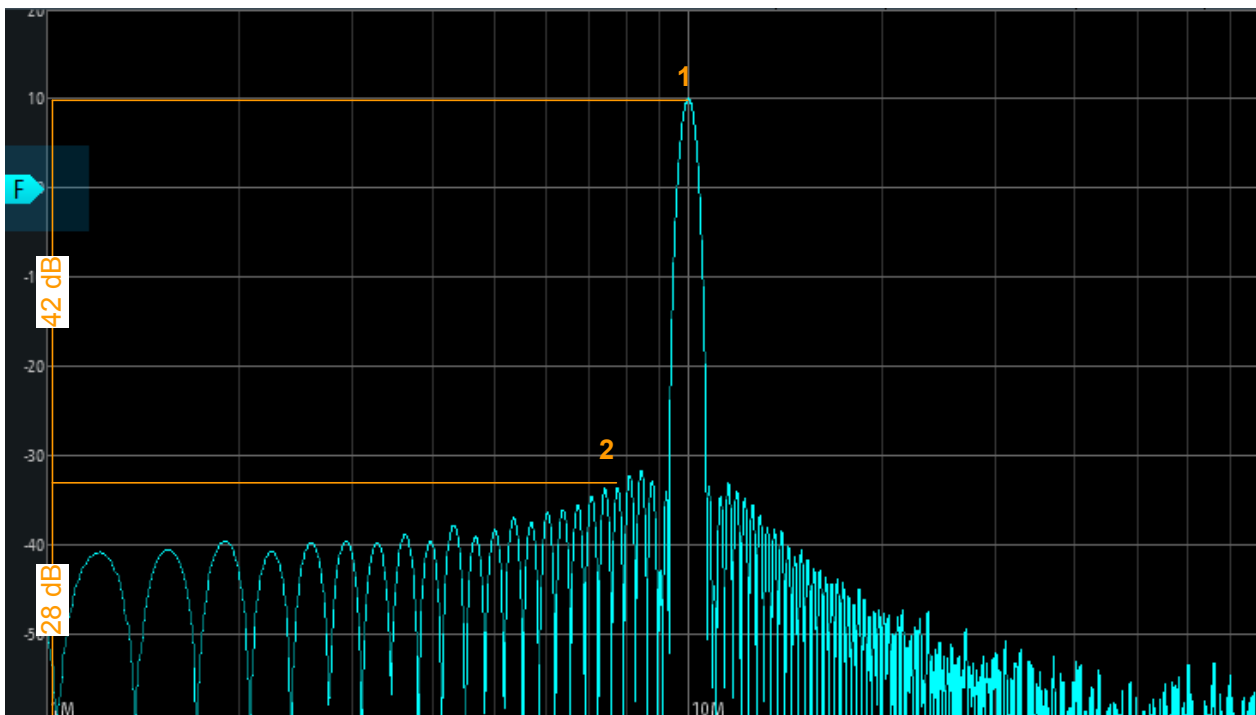

If "Peak excursion" is 30 dB, the peak 1 is found. If "Peak excursion" is 20 dB, also the peak 2 and several others are found.

Remote command:

[SPECTrum:MARKer:SETup:EXCursion](#) on page 368

Distance

Defines a minimum distance between two frequencies that must be exceeded in order to detect individual peaks.

Remote command:

[SPECTrum:MARKer:SETup:DIStance](#) on page 368

Trace Source

Selects the trace on which the markers are placed. Only active traces are available (see "Trace mode (Clear/Write/ Max Hold/ Min Hold/Average)" on page 124).

Remote command:

[SPECTrum:MARKer:SOURce](#) on page 368

Marker Value

Determines whether the absolute measured results at each cursor position are displayed, or the delta between the cursors.

Remote command:

[SPECTrum:MARKer:RESult<m>:FREQuency\[:VALue\]?](#) on page 369

[SPECTrum:MARKer:RESult<m>:FREQuency:DELTA?](#) on page 369

[SPECTrum:MARKer:RESult<m>:LEVel\[:VALue\]?](#) on page 370

[SPECTrum:MARKer:RESult<m>:LEVel:DELTA?](#) on page 370

6.2.7 Cursor Measurements on Spectrums

Track cursors are available for spectrum data to determine the power or power density in a specific frequency range.

6.2.7.1 Cursor Measurement Results

For the spectrum diagram, special track cursors are available. If enabled, you can place the two cursors at any position in the spectrum. As a result, the frequency and measured power levels of the selected trace at the crossing point with the cursors are displayed. Both the power and the power density for each cursor are indicated. Instead of the absolute results for the second cursor, the delta between both cursors can be provided.

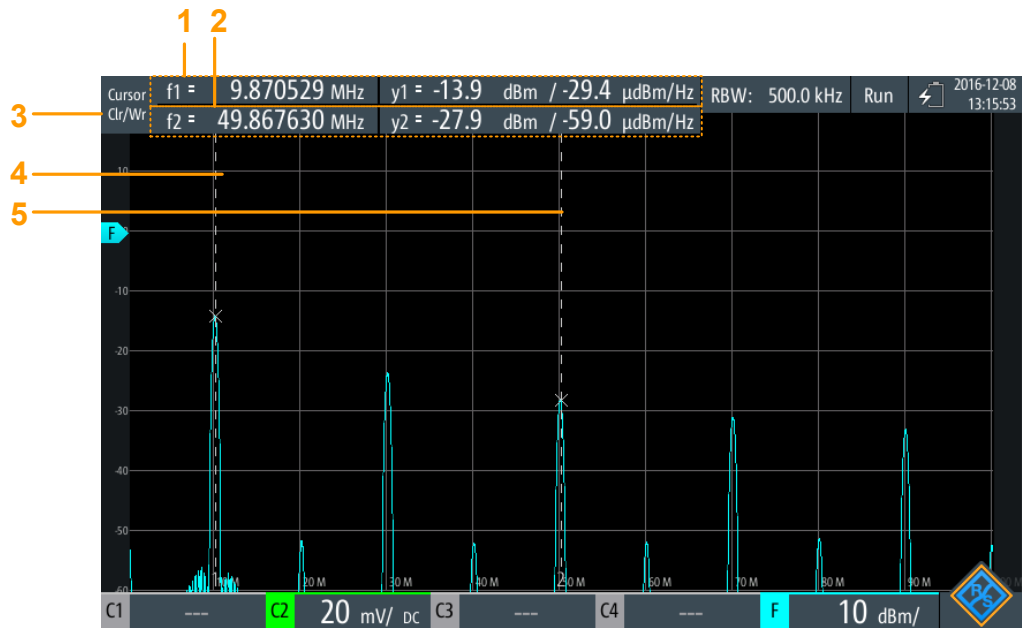

Figure 6-3: Cursor display in Spectrum mode

- 1 = Cursor 1 frequency and level results
- 2 = Cursor 2 frequency and level results
- 3 = Trace used as source for cursor results
- 4 = Cursor 1
- 5 = Cursor 2

Remote commands for results:

`SPECTrum:CURSOR<m>:FREQUENCY[:VALUE]` on page 366

`SPECTrum:CURSOR<m>:FREQUENCY:DELTA?` on page 366

`SPECTrum:CURSOR<m>:LEVEL[:VALUE]?` on page 366

`SPECTrum:CURSOR<m>:LEVEL:DELTA?` on page 366

6.2.7.2 Cursor Settings

Access: "Cursor" menu

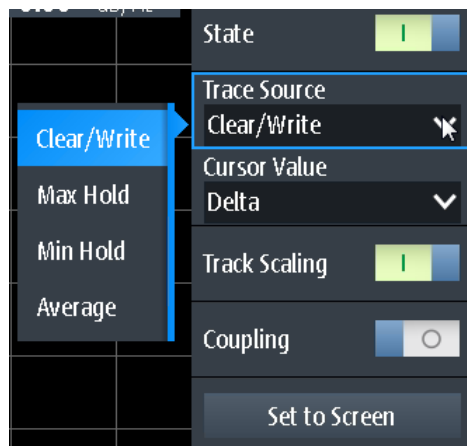
**State**

Enables or disables the spectrum cursor measurement.

Remote command:

[SPECTrum:CURSor<m>:STATe](#) on page 364

Trace Source

Selects the trace on which the cursors are placed. Only active traces are available (see "Trace mode (Clear/Write/ Max Hold/ Min Hold/Average)" on page 124).

Remote command:

[SPECTrum:CURSor<m>:SOURce](#) on page 365

Cursor Value

Determines whether the absolute measured results at each cursor position are displayed, or the delta between the cursors.

Remote command:

[SPECTrum:CURSor<m>:FREQuency\[:VALue\]](#) on page 366

[SPECTrum:CURSor<m>:FREQuency:DELta?](#) on page 366

[SPECTrum:CURSor<m>:LEVel\[:VALue\]?](#) on page 366

[SPECTrum:CURSor<m>:LEVel:DELta?](#) on page 366

Track Scaling

If enabled, the position of the cursor lines is adjusted if the vertical or horizontal scales are changed. The cursor lines keep their relative position to the waveform.

If disabled, the cursor lines remain on their position on the display if the scaling is changed.

Remote command:

[SPECTrum:CURSor<m>:SCPLing](#) on page 365

Coupling

Couples the cursor lines so that the distance between the two lines remains the same if one cursor is moved.

Remote command:

[SPECTrum:CURSor<m>:COUPLing](#) on page 365

Set to Screen

Sets the cursors to a default position on the screen. This is helpful if the cursors have disappeared from the display or need to be moved for a larger distance.

Remote command:

[SPECTrum:CURSor<m>:SCReen](#) on page 367

6.2.8 Export Spectrum Data to File

Access: [MODE] = "Spectrum" > [FILE] > "Spectrum"



The results of a spectrum measurement can be exported similarly to a waveform (see also [Chapter 12, "Documenting Results"](#), on page 268). The OneTouch functionality is also available (see [Chapter 12.6, "Quick Save with OneTouch"](#), on page 280).

File Format

Selects the format of the export file. For details on the file format, see [Chapter 6.2.9, "Export File Format for Spectrum Results"](#), on page 133.

"CSV" Comma-separated values (CSV) text file, the waveform is stored in a table. The columns are separated by commas or another delimiter. For each sample, one line is written. Values are listed in scientific notation. You can convert the comma-separated text to columns.

"Compressed CSV" ZIP file that contains one or more CSV files. This format reduces the file size.

Remote command:

[SPECTrum:EXPort:NAME](#) on page 371

Save Spectrum, Save Spectrum As

Save the spectrum results.

"Save" Saves the file in the defined "Directory" using the autonaming pattern.

"Save As" Opens a file explorer where you can select the directory and enter the filename.

Remote command:

`SPECTrum:EXPort:SAVE` on page 371

Directory

Defines the directory where the spectrum files are stored. If a USB flash drive is connected, the instrument stores the data to this external device by default.

Remote command:

`SPECTrum:EXPort:NAME` on page 371

Filename Base

Defines the first part of the filename. The complete filename pattern is:

`<filename base>_<date>_<timestamp>.csv.`

Remote command:

`SPECTrum:EXPort:NAME` on page 371

Store with Freq.

Includes the frequency values in the stored results.

Remote command:

`SPECTrum:EXPort:INCXvalues` on page 371

CSV Column Delimiter

Selects the column delimiter for CSV files. You need to know the delimiter when you convert the CSV text to columns in a spreadsheet.

6.2.9 Export File Format for Spectrum Results

The spectrum results export file format is similar to a waveform export file; it is also stored in CSV format. You can convert the comma-separated text to columns (see [Chapter 12.4.3.3, "Converting CSV to Excel Files"](#), on page 279).

Table 6-5: Header data (converted to table)

Spectrum Results	[Example data]
Model	RTH1004
SerialNumber	xxxxx
Firmware Version	'1.60'
Acquisition Time Stamp	2017-07-31 14:27:35.96278902
Center Frequency [Hz]	2.5e+008
Span [Hz]	5e+008
RBW [Hz]	2.5e+006
Window	Hann
Number of Average [n] (used for average trace)	64
Record Length [n]	6554

Start Frequency [Hz]	0
Frequency Resolution [Hz]	76293.9

Table 6-6: Spectrum (trace) data (converted to table data)

Frequency	Clear/Write	Max	Min	Average
[Hz]	[V]/[A]*	[V]/[A]*	[V]/[A]*	[V]/[A]*
0	0.000113039			
76293.9	0.000226932			
...				
*) depends on probe setting				



Converting voltage or Ampere to power values

The spectrum results are provided as voltages or in Amperes (depending on the probe setting). To convert these results (U/I) to power values (P), use the following equations:

$$P_{dBV}(U) = 20 \cdot \lg\left(\frac{U}{1V}\right)$$

$$P_{dBA}(I) = 20 \cdot \lg\left(\frac{I}{1A}\right)$$

$$P_{dBm}(U) = 10 \cdot \lg\left(\frac{P}{1mW}\right) = 10 \cdot \lg\left(\frac{U^2}{R} / 1mW\right) = P_{dBV}(U) + 30 - 10 \cdot \lg\left(\frac{R}{1\Omega}\right)$$

$$P_{dBm}(I) = 10 \cdot \lg\left(\frac{P}{1mW}\right) = 10 \cdot \lg\left(\frac{I^2 \cdot R}{1mW}\right) = P_{dBA}(I) + 30 + 10 \cdot \lg\left(\frac{R}{1\Omega}\right)$$

Where:

- R = 50 Ω
- P = U * I = U² / R = I² * R

6.3 Harmonics Measurement (Option R&S RTH-K34)

With this measurement, you can easily measure the harmonics of an input signal. In addition, the total harmonic distortion (THD) is calculated.

The harmonics measurement performs an FFT on the input signal and determines the power levels measured at the specified fundamental frequency and at each harmonic. Harmonics are frequencies that are a multiple of the fundamental frequency.

As a result, the magnitude, frequency and phase values for the selected harmonics are shown, as well as the RMS power values and the total harmonic distortion (THD).

In general, every signal contains harmonics. Harmonics are generated by nonlinear characteristics, which add frequencies to a pure sine wave. Harmonics are particularly critical regarding high-power transmitters such as transceivers because large harmonics can interfere with other radio services.

Harmonic distortion can be determined as the level of the individual components, or as the root mean square of all components together, the total harmonic distortion (THD). The THD is set in relation to the power of the fundamental frequency.

6.3.1 Accessing the Harmonic Mode

1. Press the [MODE] key.

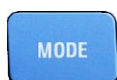

2. Select "Harmonic".

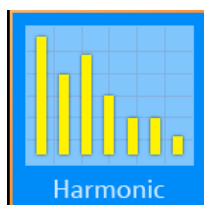

An FFT is performed on the input signal, and the power level at the fundamental and all harmonic frequencies of the signal (that is: all multiples of the fundamental frequency) are analyzed.

6.3.2 Harmonic Measurement Results and Display

As the result of a harmonic measurement, a bargraph is displayed, with one bar for each of 64 possible harmonic frequencies. The amplitudes determined for each harmonic are indicated by a colored bar. The results for each active input channel are displayed in a different color. The values are scaled in dB or percent, in relation to the level at the fundamental frequency. If a limit is defined, either manually or predefined by a standard, the limit is indicated by a blue horizontal line for each harmonic. If the measured value exceeds the limit, the background is highlighted red. The darker colored bar indicates the maximum value measured for the harmonic.

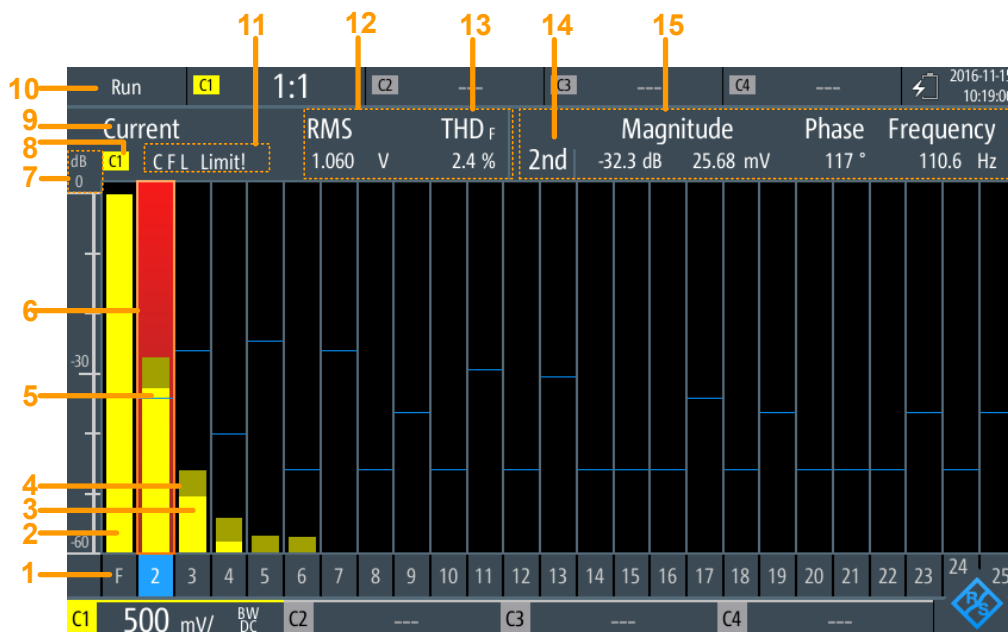

Figure 6-4: Harmonic results and display

(1) Order of harmonic.....	136
(2) Power level of fundamental frequency.....	136
(3+4) Power level of individual harmonics.....	137
(5+6) Limit line and check for individual harmonics.....	137
(7) Power level scale.....	137
(8) Input channel.....	137
(9) Result type for numeric results.....	137
(10) Operating status.....	138
(11) Error indicator.....	138
(12) RMS.....	138
(13) Total harmonic distortion (THD).....	138
(14) Selected harmonic.....	139
(15) Numeric results for selected harmonic.....	139

(1) Order of harmonic

Results are displayed for each of 64 possible harmonic frequencies. You can restrict the number of harmonics to be analyzed (see "Display Harmonics, Max No Harmonics" on page 143).

Remote command:
(determined by suffix <n> in remote command)

(2) Power level of fundamental frequency

The calculated power level at the fundamental frequency. The graphical level results are indicated in relation to the power level of the fundamental frequency. Thus, this bar is always at 100 % or 0 dB.

Remote command:
HARMonic:REsult<m>:HARMonics1:ABSMagnitude?

(3+4) Power level of individual harmonics

For each harmonic and each input channel, a colored bar indicates calculated power level at the selected harmonic frequency, set in relation to the power level of the fundamental frequency. The color of the bar corresponds to the color of the input channel.

The brighter colored bar is the current value, while the darker colored bar is the maximum value in the current measurement.

Remote command:

`HARMonic:RESult<m>:HARMonics<n>:ABSMagnitude[:CURRent]?`

on page 378

`HARMonic:RESult<m>:HARMonics<n>:ABSMagnitude:MAXimum?` on page 378

`HARMonic:RESult<m>:HARMonics<n>:ABSMagnitude:MINimum?` on page 378

`HARMonic:RESult<m>:HARMonics<n>:RELMagnitude[:CURRent]?`

on page 381

`HARMonic:RESult<m>:HARMonics<n>:RELMagnitude:MAXimum?` on page 381

`HARMonic:RESult<m>:HARMonics<n>:RELMagnitude:MINimum?` on page 381

(5+6) Limit line and check for individual harmonics

If a limit is defined for the individual harmonic, it is indicated in the graphic (see "[Limits, Loaded File](#)" on page 142). If the measured value exceeds the limit line, the background of the harmonic bar is highlighted red.

Remote command:

`HARMonic:RESult<m>:HARMonics<n>:LIMit?` on page 379

`HARMonic:RESult<m>:HARMonics<n>:LIMCheck?` on page 378

`HARMonic:RESult<m>:HARMonics<n>:LIMViolation?` on page 380

(7) Power level scale

Indicates whether the bargraph results are displayed in percent or dB.

Remote command:

`HARMonic:SCALE` on page 375

(8) Input channel

Harmonics measurement is performed on the data captured from one of the active input channels. The measurement can be performed on all channels simultaneously. The bars and numeric results for each channel are displayed in the same color as the channel indicator.

Remote command:

`CHANnel<m>:STATE` on page 304

(9) Result type for numeric results

Either the currently measured numeric values, or the minimum or maximum values can be displayed. The selected result type is indicated above the diagram. The bargraph always displays both the current and the maximum values.

In addition, an average over several measurements can be calculated (not indicated in the diagram.)

Remote command:

`HARMonic:STATistic` on page 376

(10) Operating status

Indicates the status of the harmonic measurement ("Hold"/"Run").

(11) Error indicator

If an error occurs during the measurement, an indicator is displayed above the bar-graph. These indicators remain visible throughout the measurement, for all acquisitions. In addition, the long form of the error is indicated, blinking, for the duration of the acquisition in which an error occurs only.

The following errors may be indicated:

- **"C"** (Clipping)

The amplitudes determined for each frequency must be within the currently defined amplitude range in order to be measured correctly. If the signal is not entirely within the defined range, a "Clipping" message is displayed next to the channel indicator in the numeric result area of the screen. The measurement is invalid and no results are calculated.

To change the amplitude range, use the [\[RANGE\]](#) keys or the [AUTOSET] function.

- **"F"** (Frequency)

If the specified [fundamental frequency](#) $\pm 10\%$ is not detected in the signal, the measurement is invalid.

- **"L"** (Limit)

If a limit check is activated and the measured value exceeds the specified limit for a harmonic, a limit violation has occurred. The background of the harmonic is highlighted red.

Remote command:

[HARMonic:RESult<m>:CLIPping?](#) on page 377

[HARMonic:RESult<m>:FRQMissing?](#) on page 377

[HARMonic:RESult<m>:LIMViolation?](#) on page 381

(12) RMS

The calculated root mean square (RMS) amplitude in the entire signal, that is: for all harmonics and the fundamental frequency.

$$U_{RMS} = \sqrt{\frac{1}{n} \cdot \sum_{k=0}^{N-1} u^2(k)}$$

Remote command:

[HARMonic:RESult<m>:RMS\[:CURRent\]?](#) on page 382

[HARMonic:RESult<m>:RMS:MINimum?](#) on page 382

[HARMonic:RESult<m>:RMS:MAXimum?](#) on page 382

(13) Total harmonic distortion (THD)

THD (total harmonic distortion), that is: the root mean square (RMS) amplitude (voltage or current) of the harmonics.

The value is provided either:

- Relative to the RMS amplitude at the fundamental frequency (first harmonic, THD_F):

$$THD_F = \frac{I}{U_{RMS,I}} \cdot \sqrt{\sum_{i=2}^{64} U_{RMS,i}^2}$$

- Relative to the total power of the signal (THD_R):

$$THD_R = \frac{THD_F}{\sqrt{1 + THD_F^2}}$$

Remote command:

[HARMonic:RESult<m>:THD\[:CURRent\]? on page 383](#)

[HARMonic:RESult<m>:THD:MINimum? on page 383](#)

[HARMonic:RESult<m>:THD:MAXimum? on page 383](#)

[HARMonic:THDType on page 376](#)

(14) Selected harmonic

Some results are provided for a single, selected harmonic. You select the harmonic by tapping the number at the bottom of the bargraph. The selected harmonic is highlighted.

Remote command:

(determined by suffix <n> in remote command)

(15) Numeric results for selected harmonic

The following numeric results are displayed for the [\(14\) Selected harmonic](#):

- Order of the harmonic
- Magnitude (relative to [\(2\) Power level of fundamental frequency](#) and absolute value)
- Phase (percent or dB, depending on [Scale](#) setting)
- Frequency

Remote command:

[HARMonic:RESult<m>:HARMonics<n>:ABSMagnitude\[:CURRent\]? on page 378](#)

[HARMonic:RESult<m>:HARMonics<n>:ABSMagnitude:MINimum? on page 378](#)

[HARMonic:RESult<m>:HARMonics<n>:ABSMagnitude:MAXimum? on page 378](#)

[HARMonic:RESult<m>:HARMonics<n>:RELMagnitude\[:CURRent\]? on page 381](#)

[HARMonic:RESult<m>:HARMonics<n>:RELMagnitude:MINimum? on page 381](#)

[HARMonic:RESult<m>:HARMonics<n>:RELMagnitude:MAXimum? on page 381](#)

[HARMonic:RESult<m>:HARMonics<n>:PHASe? on page 380](#)

[HARMonic:RESult<m>:HARMonics<n>\[:FREQuency\]? on page 381](#)

6.3.3 Performing a Harmonic Measurement

1. Select the "Harmonic" mode.
2. To adjust the instrument settings to the current input signal automatically, press [AUTOSET].

The [AUTOSET] function detects the fundamental frequency in the signal automatically if it lies between 10 Hz and 1 kHz. If none of the predefined values (50 Hz, 60 Hz, 400 Hz) fit, a "User" value is set.

3. Alternatively to the [AUTOSET] function, define the "Fundamental Frequency" manually. Select "User" and enter the frequency.
4. If a "Clipping" message is displayed next to the channel indicator in the numeric result area of the screen, the signal is not entirely within the defined measurement range. Use the [AUTOSET] key or the [RANGE] keys to correct the range.
5. To perform a limit check, do one of the following for the "Limits" setting:
 - To check the limits specified by the standard, select "EN50160".
 - To configure user-specified limits in a file, select "User" and open the .csv file.
6. To restrict the number of harmonics to be displayed in the bargraph, use the "Display Selection" setting. Select a predefined selection, or define the number in the "Max No Harmonics" field.
7. To display the results for a specific harmonic, select the number below the bar in the graph.
8. To calculate the average results over several measurements, select "Average" and define the number of results to consider.
9. To clear the result data used for statistical evaluation and start a new measurement, select "Clear Results".

To save the results to a file

1. Press the [FILE] key.
2. Select "Harmonics".
3. Check the "Harmonic Directory" and the "Filename Base". Adjust if necessary.
4. Select "Save".

For details on the format of the result file, see [Chapter 6.3.6.2, "Export File Format for Harmonic Results"](#), on page 145.

6.3.4 Harmonic Mode Settings

Access: "Harmonic" menu

[CH <n>].....	141
Scale.....	141
THD Type.....	141
Statistic.....	141
Clear Results.....	141
Fundamental Frequency, Value.....	141

Limits, Loaded File..... 142
 Open..... 142
 Display Harmonics, Max No Harmonics..... 143
 Average..... 143



[CH <n>]

Selects the channel for which the captured data is analyzed in "Harmonic" mode. Harmonic measurements can be performed on all channels simultaneously. The results are indicated by different colored bars and numbers, corresponding to the channel button color.

Remote command:

[CHANnel<m>:STATe](#) on page 304

Scale

Switches the scale for the measured harmonic levels between logarithmic (dB) and linear (percent). The values are relative to the level measured for the fundamental frequency.

Remote command:

[HARMonic:SCALE](#) on page 375

THD Type

Switches between different calculation methods for the total harmonic distortion.

- "THD_F" The RMS amplitude (voltage or current) of the harmonics relative to the RMS amplitude of the fundamental component
- "THD_R" The RMS amplitude of the harmonics relative to the RMS amplitude of the input signal

Remote command:

[HARMonic:THDType](#) on page 376

Statistic

By default, the numeric results indicate the currently measured values. Optionally, you can switch to the minimum or maximum values. Which value is calculated is indicated in the result display (see "(9) Result type for numeric results" on page 137).

Note: The bargraph always displays both the current and the maximum values.

Remote command:

[HARMonic:STATistic](#) on page 376

Clear Results

Clears the results for previous acquisitions used in statistical evaluation (see "Statistic" on page 141 and "Average" on page 143).

Remote command:

[HARMonic:CLEar](#) on page 372

Fundamental Frequency, Value

Defines the basis of the harmonics measurement. Harmonics are determined as multiples of this frequency.

For a user-defined frequency, select "User" and enter the "Value".

If the specified frequency $\pm 10\%$ is not detected in the signal, the measurement is invalid. An "F" is displayed as an error indicator.

Remote command:

[HARMonic:FUNDamental:TYPE](#) on page 373

[HARMonic:FUNDamental:USER](#) on page 374

[HARMonic:RESult<m>:FRQMissing?](#) on page 377

Limits, Loaded File

Defines for which harmonics a limit check is to be performed. If a limit check is activated and the specified limit is exceeded for a harmonic, the background of the harmonic is highlighted red in the graphic. In addition, an "L" is displayed as an error indicator.

"Limit!" is indicated during the acquisition in which the violation occurs.

If the number of harmonics to be analyzed is restricted by a standard or a user-defined file, only the results for those harmonics can be displayed or exported (see also "[Display Harmonics, Max No Harmonics](#)" on page 143).

"None"	No limit check is performed. All 64 harmonics can be displayed and exported.
"EN50160"	Limits are checked according to the predefined values in the EN50160 standard. Only specific harmonics are selected for analysis.
"User"	Limits are checked according to the values in a user-defined file. For details on the required file format, see Chapter 6.3.6.1, "Limit File Format" , on page 144. If a user-defined limit file is loaded for harmonics measurement, only the results for the specified harmonics are calculated, displayed, and exported. A limit check is performed only for those harmonics for which a limit value is defined. If "User" is selected, the "Loaded File" field indicates the currently loaded file. Select the file that contains the user-defined limits using the Open function.

Remote command:

[HARMonic:LIMits:TYPE](#) on page 375

Open

Opens a user-defined file that contains the selection of harmonics and, optionally, the limits for individual harmonics.

The "Loaded File" field indicates the currently loaded file.

Note that this setting is only available if [Limits](#) is set to "User".

Remote command:

[HARMonic:LIMits:NAME](#) on page 374

[HARMonic:LIMits:LOAD](#) on page 375

[HARMonic:RESult<m>:NOHarmonics?](#) on page 382

[HARMonic:FUNDamental:CURRent?](#) on page 374

Display Harmonics, Max No Harmonics

Determines the number of harmonics to be displayed in the bargraph. Up to 64 harmonics can be displayed. By decreasing the number of harmonics, the bargraph becomes easier to analyze.

Note that this setting only affects the graphical result display. It has no effect on the measurement results or the selection of harmonics for which results are provided during a file export (manually or via remote command). For that purpose, see [Limits](#).

Harmonics that were previously eliminated by the [Limits](#) setting cannot be displayed.

To restrict the number of harmonics to display, select a predefined selection, or "User" and enter the "Max No Harmonics". All harmonics of an order smaller than or equal to the specified value (and selected for analysis) are displayed.

Remote command:

[HARMonic:DISPlay:TYPE](#) on page 372

[HARMonic:DISPlay:USER](#) on page 373

[HARMonic:RESult<m>:NOHarmonics?](#) on page 382

Average

Determines the number of acquisitions for which the results are averaged. By default, no averaging is performed.

Note that invalid measurements (for example due to clipping or a missing fundamental frequency) are not considered for averaging.

To clear the results for previous acquisitions used for averaging, select [Clear Results](#).

Remote command:

[HARMonic:AVERage](#) on page 372

6.3.5 Export Harmonic Results to File

Access: [MODE] = "Harmonic" > [FILE] > "Harmonics"

The results of a harmonic measurement can be exported similarly to a waveform (see also [Chapter 12, "Documenting Results"](#), on page 268). The OneTouch functionality is also available (see [Chapter 12.6, "Quick Save with OneTouch"](#), on page 280).

For details on the export file format, see [Chapter 6.3.6.2, "Export File Format for Harmonic Results"](#), on page 145.

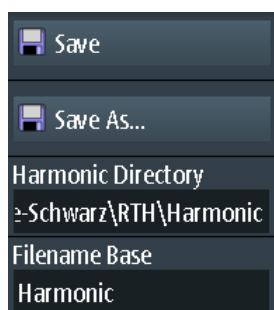

Save, Save As

Save the harmonic results. The functions are available if the instrument is in "Harmonics" mode.

"Save"	Saves the file in the defined "Harmonic Directory" using the autonaming pattern.
"Save As"	Opens a file explorer where you can select the directory and enter the filename.

Remote command:

[HARMonic:EXPort:SAVE](#) on page 377

Harmonic Directory

Defines the directory where the harmonic results files are stored. If a USB flash drive is connected, the instrument stores the data to this external device by default.

Remote command:

[HARMonic:EXPort:NAME](#) on page 377

Filename Base

Defines the first part of the filename. The complete filename pattern is:

<filename base>_<date>_<time>.csv.

Remote command:

[HARMonic:EXPort:NAME](#) on page 377

6.3.6 File Formats for Harmonic Results and Limits**6.3.6.1 Limit File Format**

The limit file defines which harmonics are of interest for analysis, and optionally, the limits against which each harmonic is to be tested. If a user-defined limit file is loaded for harmonics measurement, only the results for the specified harmonics are calculated, displayed, and exported. A limit check is performed only for those harmonics for which a limit value is defined.

**Sample file**

A sample limit file is provided on the instrument:

C:\Users\<<user_name>\Rohde-Schwarz\RTH\Harmonic\LimitExample.csv

The file format is a comma-separated list (.csv). At least the following contents must be included:

Header:

<Device>,Version,<file_version>

Harmonics,Limit[%]

Values:

<Order of harmonic>, <limit value in % of fundamental>



- Comments introduced by "#" are allowed.
- If a limit is not provided for a harmonic, the harmonic is displayed and its results are included in the export, but not in the limit check.
- The fundamental is always displayed and need not be included in the list.

Example:

```
RTH,Version,1.0
Harmonics,Limit[%]
2,10.5
4,0.004
20,3.7
10
13,0.01
3,0.01
```

6.3.6.2 Export File Format for Harmonic Results

The harmonic results export file format is similar to a waveform export file; it is also stored in CSV format. You can convert the comma-separated text to columns (see [Chapter 12.4.3.3, "Converting CSV to Excel Files"](#), on page 279).

The harmonics results file contains some general header data and then a set of result data for each harmonic. A maximum of 64 results can be provided, but the actual number of harmonics may be restricted (see ["Limits, Loaded File"](#) on page 142). Each set of data contains the results for a specific harmonic in each input channel.

Table 6-7: Header data (converted to table)

Harmonic Results					[Description - not included in file]
Model	RTH1004				
SerialNumber	xxxxx				
Firmware Version	'1.50'				
ID	CH1	CH2	CH3	CH4	Results for each channel
NbOfResults [n]					Number of results included in averaging and statistics operations
RMS Unit					Unit used for RMS results
RMS					Current RMS of the signal power (
RMS Max					Maximum RMS of the signal power
RMS Min					Minimum RMS of the signal power
THDf/ THDr [%]					Current THD in relation to the RMS amplitude of the fundamental frequency (THDf) or the total power of the signal (THDr)

THDf/ THDr Max [%]					Maximum THD
THDf/ THDr Min [%]					Minimum THD
Clipping [bool]					Clipping occurred during the measurement?
FrequencyMissing [bool]					Fundamental frequency could not be measured?
LimitViolation [bool]					A limit was exceeded?
Average					Number of acquisitions for which the results are averaged. By default, no averaging is performed.

Table 6-8: Results for individual harmonics (converted to table data)

		Ch 1						Ch 2 ...		
Harmonic ID	Limit	Freq.	Magn. current	Magn. max	Magn. min	Phase	Limit violation	Limit	Freq.	Magn. current
[n]	[%]	[Hz]	[V]	[V]	[V]	[deg]	[bool]	[Hz]	[V]	[V]
1										
2										
...										

7 Multimeter Measurements

The 4-channel R&S RTH1004 has 4 software-based voltmeters, which can measure in parallel. For each voltmeter you can select the source and measurement type. See [Voltmeter \(R&S RTH1004\)](#).

The 2-channel R&S RTH1002 has a hardware-based digital multimeter with two separate banana plug inputs for various multimeter measurements. Except for voltages, the DMM can also measure resistance, capacitance, temperature and more. See [Digital Multimeter \(R&S RTH1002\)](#).

7.1 Digital Multimeter (R&S RTH1002)

The hardware-based digital multimeter features various multimeter measurements. Except for voltages, the DMM can also measure resistance, capacitance, temperature and more.

The R&S RTH can run one DMM measurement at a time, the maximum resolution is 10000 counts and 4 digits.

The measurement range can be set automatically or manually. In auto range, the instrument sets the range so that it can measure and display with maximum accuracy. Probe settings are not affected, and statistical results are kept when the instrument adjusts the range automatically. Auto range is available for all voltage and current measurements, and also for resistance, capacitance and frequency measurements.

In "Meter" mode, a separate self-alignment of the meter inputs is available, see [Chapter 13.3, "Selfalignment"](#), on page 284.

All remote commands for configuration and measuring are listed in [Chapter 15.7, "Digital Multimeter \(R&S RTH1002\)"](#), on page 383.

7.1.1 Connecting Test Leads (R&S RTH1002)

The R&S RTH1002 has an integrated digital multimeter (DMM) and test leads for multimeter measurements.



Figure 7-1: Meter inputs to connect test leads

1. Connect the leads first to the DMM inputs at the top of the instrument, and then to the DUT.
2. To start meter measurements, press the [DMM] key.

7.1.2 Accessing the Meter Mode

- ▶ There are several ways to start the multimeter mode:

- Press the [DMM] key.



- Press the [MODE] key, and select "Meter".

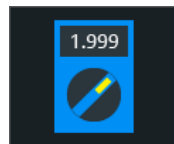
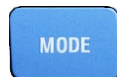

- To start relative measurements, press the [DMM REL] key.

The multimeter interface is displayed, and the measurement is started immediately.

7.1.3 Display and Control

The multimeter display shows detailed results and setup icons.

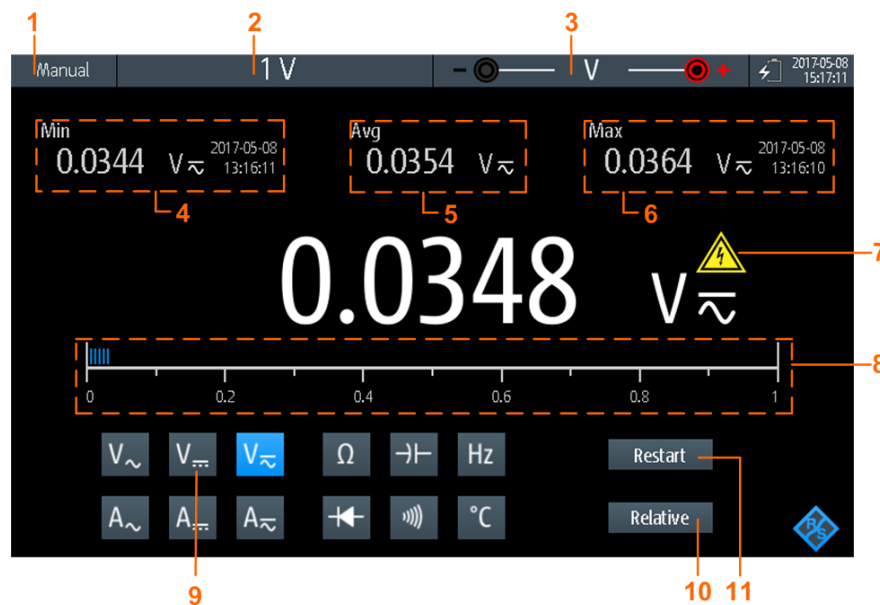

Figure 7-2: Display of the digital multimeter

- 1 = Measurement state. "Manual" or "Auto": running measurement with manual or automatic range. "Hold": stopped measurement.
- 2 = Measurement range
- 3 = Test lead connection including polarity
- 4 = Minimum value and timestamp
- 5 = Average value
- 6 = Maximum value and timestamp
- 7 = Warning sign, shows up if the measured value is higher than 30 V
- 8 = Bargraph displaying the measured value
- 9 = Measurement type
- 10 = Activates or deactivates relative measurement
- 11 = Restarts the measurement and resets all values

In meter mode, the keys behave slightly different from scope mode:

- The AUTOSSET key toggles the range mode: autoranging and manual range setting.
- The vertical [RANGE] and [POS] keys adjust the measurement range.
- The [MEAS] key opens the "Meter" menu.
- The following keys work as usual: [FILE], [G], [M], [PRESET], [MODE], [BACK].
- The [CH] keys switch back to the scope mode.
- All other keys do not work.

7.1.4 Running Multimeter Measurements

1. Connect the test leads to the meter inputs.
2. Select the "Meter" mode.
3. Select the measurement type (no. 9 in [Figure 7-2](#)).

4. To set the range mode to autoranging or manual range setup, press [AUTOSET].
5. If you are in manual range mode, adjust the measurement range: Press the [RANGE] keys.
6. For current and temperature measurements, adjust the "Probe Setting" in the "Meter" menu.
7. For continuity measurement, adjust the "Resistance Threshold".
8. If you want to get relative result values:
 - a) Activate "Relative" (no. 10).
 - b) To set a user-defined reference value, open the "Meter" menu.
 - c) Activate "Reference".
 - d) Enter the reference value in "Reference Manual".
9. To stop the meter measurement, press the [RUN STOP] key.



The status "Hold" is displayed on the upper left. Stopping the measurement does not delete statistical values. The measurement continues when you press [RUN STOP] again.

7.1.5 Settings

Access: "Meter" menu

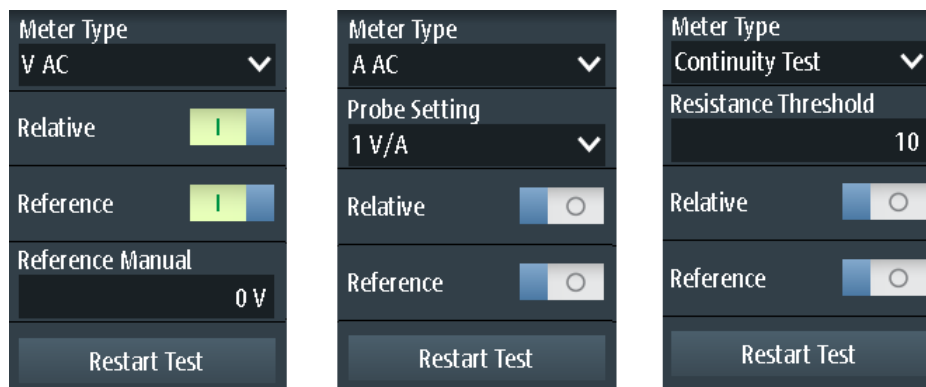











Figure 7-3: Digital multimeter settings

Meter Type

Sets the measurement type for the multimeter.

Meter icon	"Meter Type"	Description
	"V AC"	AC voltage measurement
	"V DC"	DC voltage measurement
	"V AC+DC"	AC+DC voltage (RMS) measurement

Meter icon	"Meter Type"	Description
	"A AC"	AC current measurement
	"A DC"	DC current measurement
	"A AC+DC"	AC+DC current (RMS) measurement
	"Resistance"	Resistance measurement
	"Continuity Test"	Continuity measurement
	"Diode Test"	Diode measurement
	"Capacitance"	Capacity measurement
	"Temperature"	Temperature measurement (an adapter is required)
	"Frequency"	Frequency measurement

Remote command:

`METer<m>:SENSe:FUNction` on page 406

Probe Setting

Sets the sensitivity factor of the current probe for current measurements.

Sets the adapter type for temperature measurements.

Resistance Threshold

This setting is only relevant for continuity measurement. If the measured voltage drops below the "Resistance Threshold", the instrument beeps.

Relative

Activates or deactivates relative measurement. If you activate this function, the currently measured value is taken as reference value. Instead of the bargraph, the reference value and the measured value are displayed. You can also set a desired value as reference value, see "[Reference/Reference Manual](#)" on page 152.

You can also activate or deactivate relative measurement by pressing [DMM REL].

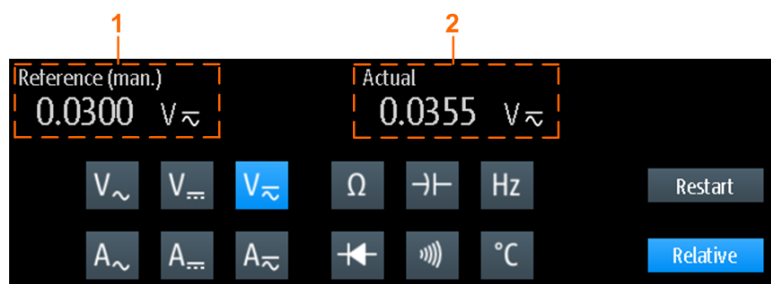

- 1 = Reference value
- 2 = Actual value relative to reference value

Remote command:

[Chapter 15.7.3, "Relative Measurements"](#), on page 391...

Reference/Reference Manual

"Reference" activates or deactivates the setting of a manual reference value.

If active, enter the reference value in "Reference Manual".

Restart Test

Restarts the measurement.

[RANGE] / [POS]

In meter mode, the vertical [RANGE] and [POS] keys adjust the DMM measurement range and reset statistical values.

Remote command:

[Chapter 15.7.2, "Measurement Configuration"](#), on page 384

7.2 Voltmeter (R&S RTH1004)

The software-based voltmeter features AC, DC, AC+DC voltage measurements. Current measurements are also possible if you use a shunt resistor or I/U converter.

The R&S RTH can run four voltmeter measurement in parallel, the maximum resolution is 999 counts and 3 digits.

All remote commands for configuration and measuring are listed in [Chapter 15.8, "Voltmeter \(R&S RTH1004\)"](#), on page 399.

7.2.1 Accessing the Meter Mode

1. Press the [MODE] key.

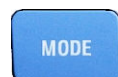

2. Select "Meter".

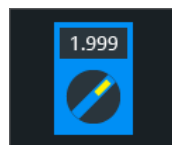

The multimeter interface is displayed.

7.2.2 Display and Control

The voltmeter display shows all 4 voltmeters at a glance, or only one voltmeter with details and setup icons.

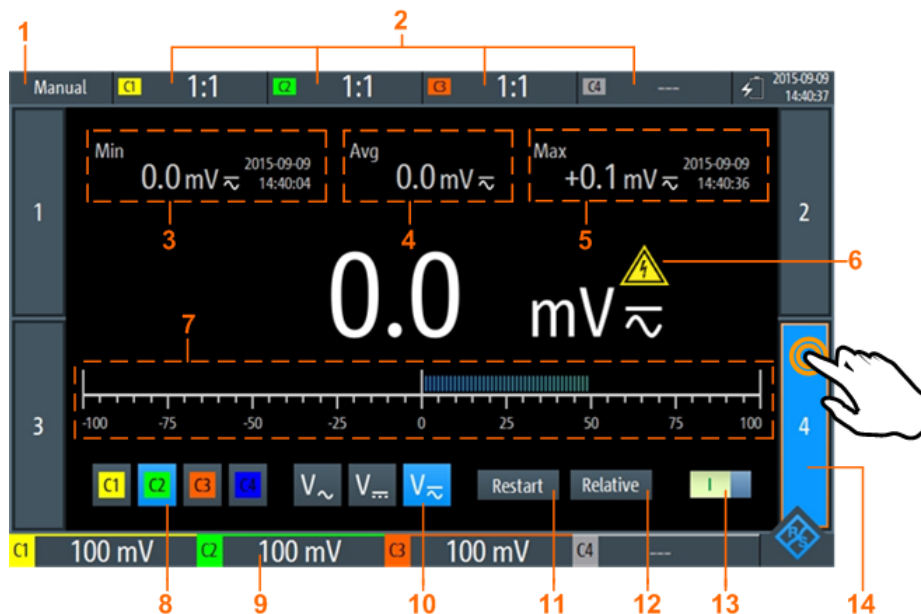

Figure 7-4: One-voltmeter-view

- 1 = Measurement state. "Manual": running measurement. "Hold": stopped measurement.
- 2 = Probe settings
- 3 = Minimum value and timestamp
- 4 = Average value
- 5 = Maximum value and timestamp
- 6 = Warning sign, shows up if the measured value is higher than 30 V
- 7 = Bargraph displaying the measured value
- 8 = Measurement source (input channel). Selected source is highlighted.
- 9 = Measurement ranges of active channels
- 10 = Measurement type (AC, DC or AC+DC). Selected type is highlighted.
- 11 = Restarts the measurement and resets all values
- 12 = Activates or deactivates relative measurement
- 13 = On/Off-Switch to turn selected meter on or off
- 14 = Displayed voltmeter, indicated by highlighted number

The buttons at the bottom of the display offer the following quick settings:

- [Input Signal](#)
- [Measure Type](#)
- [Restart Test](#)
- [Relative](#)

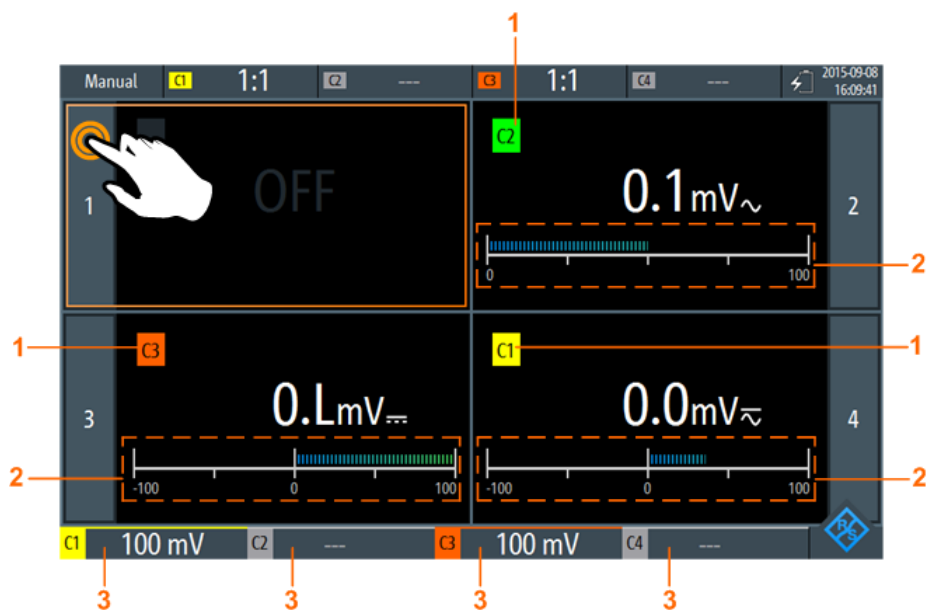

Figure 7-5: Four-voltmeter-view

- 1 = Channel measured by the voltmeter
- 2 = Bargraph displaying the measured value
- 3 = Measurement ranges of active channels

In meter mode, the keys behave different from scope mode:

- The vertical [RANGE] and [POS] keys both adjust the measurement range of the selected channel.
- The [MEAS] key opens the "Meter" menu.
- The following keys work as usual: [FILE], [Settings], [Camera], [PRESET], [MODE], [BACK].
- All other keys do not work.



Displaying voltmeters

- ▶ To switch to one-voltmeter-view, use one of the following methods:
 - Tap the meter number as shown in [Figure 7-5](#).
 - Turn the wheel to select a voltmeter, and press the wheel button to open it.
- ▶ To view all 4 voltmeters, use one of the following methods:
 - Tap the highlighted number of the opened voltmeter as shown in [Figure 7-4](#).
 - Press [BACK].

7.2.3 Running Voltmeter Measurements

1. Set up the channels for voltmeter measurements in the "Vertical" menu. See [Chapter 7.2.5, "Vertical Settings"](#), on page 157.
2. If the 4-voltmeter-view is shown, switch to the one-voltmeter-view.

See "Displaying voltmeters" on page 154.

3. Select the channel to be measured (no. 8 in [Figure 7-4](#)).
4. Select the measurement type (no. 10).
5. Activate the voltmeter (no. 13)
6. To adjust the measurement range, press the [Range] keys.
7. If you want to get relative result values:
 - a) Activate "Relative" (no. 12).
 - b) To set a user-defined reference value, open the "Meter" menu.
 - c) Activate "Reference", and enter the reference value in "Reference Manual".



8. To stop the meter measurement, press the [RUN STOP] key.
 The status "Hold" is displayed on the upper left. Stopping the measurement does not delete statistical values. The measurement continues when you press [RUN STOP] again.

Alternatively, you can select the voltmeter and adjust the meter settings in the "Meter" menu.

7.2.4 Voltmeter Settings

Access: "Meter" menu

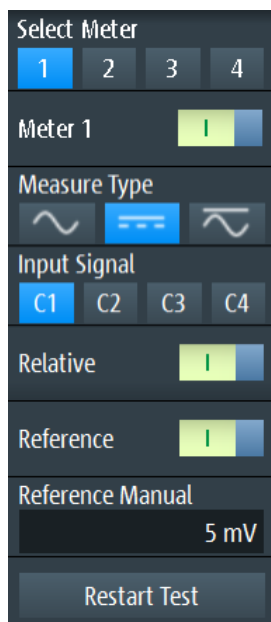

Figure 7-6: Voltmeter settings

Select Meter

Selects one of the 4 voltmeters and displays its settings in the menu.

Meter <n>

Switches the selected meter on or off.

Remote command:

`METer<m>:SENSe:STATe` on page 400

Measure Type

Sets the measurement type for the selected meter.

The AC coupling is activated if the selected channel is only used for AC measurements. If the selected channel is also used for DC or AC+DC measurement, the AC coupling is deactivated and the AC value is calculated out of the AC+DC and DC values. The precision of the results is reduced.

Menu icon	Meter icon	Description
		AC voltage or current measurement
		AC+DC voltage or current (RMS) measurement
		DC voltage or current measurement

for current measurement, an external shunt resistor or I/U converter is needed.

Remote command:

`METer<m>:SENSe:FUNction` on page 406

Input Signal

Selects the channel which is measured by the selected meter.

Remote command:

`METer<m>:SENSe:SOURce` on page 400

Relative

Activates or deactivates relative measurement. If you activate this function, the currently measured value is taken as reference value. Instead of the bargraph, the reference value and the measured value are displayed (see Figure 7-7). You can also set a desired value as reference value, see "Reference/Reference Manual" on page 157.

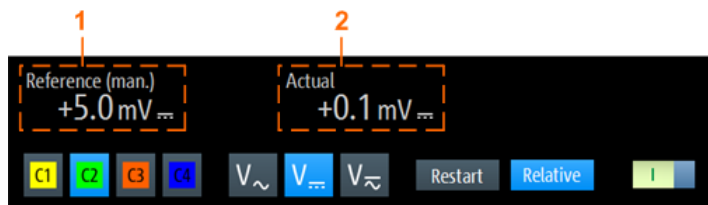

Figure 7-7: Relative measurement

- 1 = Reference value
- 2 = Measured value relative to reference value

Remote command:

[Chapter 15.8.3, "Relative Measurements"](#), on page 404

Reference/Reference Manual

"Reference" activates or deactivates the manual reference value.

If active, enter the reference value in "Reference Manual".

Restart Test

Restarts the measurement and also restarts statistical calculation.

[RANGE] / [POS]

In meter mode, the vertical [RANGE] and [POS] keys adjust the measurement range of the selected channel.

Remote command:

[Chapter 15.8.2, "Measurement Configuration"](#), on page 400

7.2.5 Vertical Settings

In "Meter" mode, only a few vertical channel settings are relevant. You can also configure the vertical settings for the input signal in "Scope" mode. When you select the "Meter" mode, the configuration is maintained.

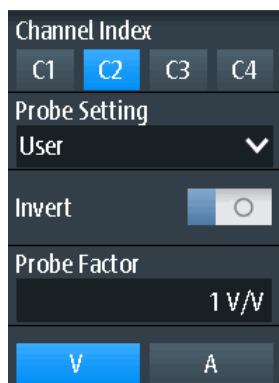

Channel Index

Selects the channel to be configured. All settings in the vertical menu belong to the selected channel.

You can also press and hold the channel key to open the corresponding vertical menu.

Probe Setting

Selects the attenuation factor of the connected probe.

The menu lists the common attenuation factors. If the required factor is not in the list, select "User" and set the ["Probe Factor"](#) on page 158.

Make sure to set the attenuation factor on the instrument according to the probe being used. Otherwise, the measurement results do not reflect the actual voltage level, and you might misjudge the actual risk.

If AC coupling is set, the attenuation of passive probes has no effect, and voltage is applied to the instrument with factor 1:1. Observe the voltage limits, otherwise you can damage the instrument.

Invert

Turns the inversion of the signal amplitude on or off. Inversion is indicated in the waveform labels by line above the channel name.

Probe Factor

Sets a user-defined attenuation factor if the probe has an uncommon attenuation, and the unit (V or A). The setting is available if "Probe Setting" is set to "User".

8 Data Logging

The data logger records scope or meter data captured of up to 4 different measurements. The logging can last up to 23 days. The records are displayed as an on-screen-chart and can be stored in 10 different slots. Using the "Zoom" and "Cursor" functions, logged data can be analyzed.

8.1 Accessing the Logger Mode

1. Press the [MODE] key.

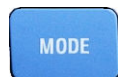

2. Select "Logger".



The logger interface is displayed.

If a scope measurement or meter measurement is running, the logging is started automatically when you enter the logger mode.

8.2 Logger Display

If you log data of scope measurements, you can log all active measurements at once. The logger display shows all logs with latest results at a glance, or one log with latest and statistical results.

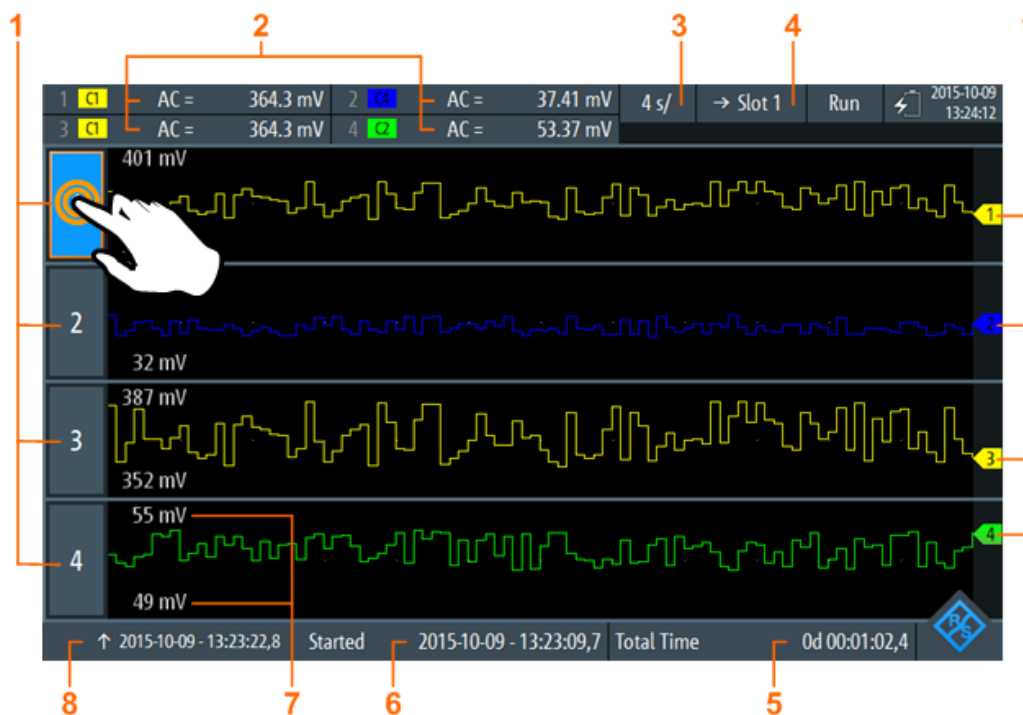

Figure 8-1: Logger display, view of all logged scope measurements

- 1 = Logger channel, each logger channel records one measurement
- 2 = Latest values of the logged measurements (depends on logging type and measurement type)
- 3 = Time basis
- 4 = In run mode (recording): →Slot <x> is the slot to which data is written. In stop mode: Slot <x> is the active slot where data has been stored to or loaded from
- 5 = Recording time
- 6 = Start time
- 7 = Upper and lower scaling value of each measurement
- 8 = Time stamp of the left side of the display

Displaying logged measurements



1. To switch to one-log-view, tap on one of the logged measurements as shown in [Figure 8-1](#).
2. To view all logs, use one of the following methods, tap the highlighted number of the open logger channel.

8.3 Using the Logger

You can log up to four different scope measurements, or meter measurements (one with R&S RTH1002, four with R&S RTH1004), or two counter measurements simultaneously. Counter measurements require option R&S RTH-K33.

8.3.1 Logging Data

Before you start the logging, set up and activate the measurements that you want to log as described in:

- [Chapter 4.2, "Automatic Measurements"](#), on page 81
- [Chapter 7, "Multimeter Measurements"](#), on page 147
- [Chapter 11, "Frequency Counter \(R&S RTH-K33\)"](#), on page 259

1. Access the logger mode, see [Chapter 8.1, "Accessing the Logger Mode"](#), on page 159.
2. Select the "Logger" menu.
3. Select the source that you want to log.
4. Select the sample rate.

If you change the source or the sample rate during running acquisition, you are asked to restart the logging with the new setting. Without logger restart, the source or sample rate remains unchanged.

5. Select the horizontal scale.
By default, the horizontal scale is set to "auto". In this case, all logged data are always displayed, and the scaling is adjusted automatically when the amount of data increases.
6. Select the slot, where the logged data will be stored.
7. Optionally, enter a name for the slot.
8. To start logging, press the [RUN STOP] key.



When you stop logging, the logged data is stored automatically in the selected slot. Each slot stores the data of a single logging period. If you use the slot a second time, the stored data is overwritten.

8.3.2 Automatic and Manual Scaling

Nomally, the instrument adjusts the vertical scale of the logger data automatically, using the statistical values. If the automatic scale and position are not optimal due to outliers in the measurement results, you can adjust the scaling manually. The scaling mode is shown in one-log-view, in the upper right corner of the screen.

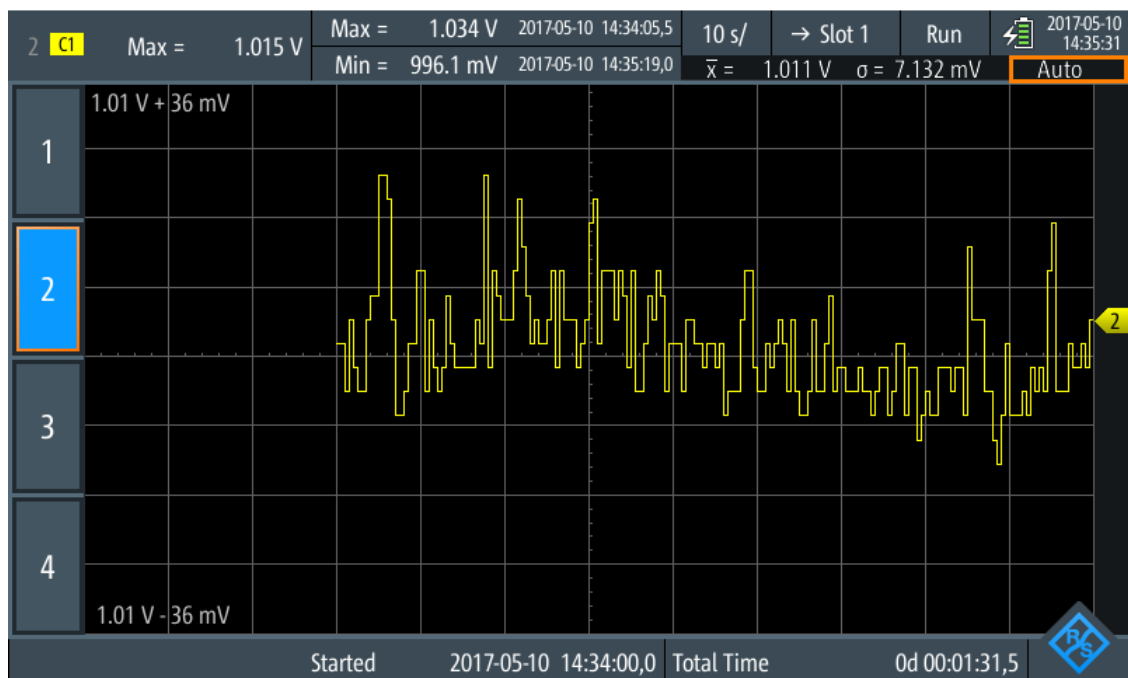

Figure 8-2: One-log-view with highlighted scaling mode

- ▶ To change the vertical scale and position manually, press the vertical [RANGE] and [POS] keys.
In both log views (one-log and all-log), the keys affect only the selected channel.
- ▶ To return a single logger channel to autoscale:
 - a) Switch to the one-log-view of the channel.
 - b) Press [AUTOSET].
- ▶ To return a all logger channels to autoscale:
 - a) Switch to the all-log-view.
 - b) Press [AUTOSET].

Note that [AUTOSET] sets also the horizontal scaling to "auto".

Remote commands:

- [LOGGer:AUToset](#) on page 421
- [LOGGer:MEASurement<m>:VERTical:AUTO](#) on page 421
- [LOGGer:MEASurement<m>:VERTical:UPPer](#) on page 421
- [LOGGer:MEASurement<m>:VERTical:LOWer](#) on page 421
- [LOGGer:MEASurement<m>:VERTical:DEVIation](#) on page 422
- [LOGGer:MEASurement<m>:VERTical:MEAN](#) on page 422

8.3.3 Loading Logged Data

Logged data can be loaded from the slot, in which they were stored.

1. Access the logger mode, see [Chapter 8.1, "Accessing the Logger Mode"](#), on page 159.
2. Select the "Logger" menu.
3. If a data logging is running, press [RUN STOP] to stop logging.
4. Select the slot with the logs that you want to display.
5. Tap "Load Slot" to display the stored logs.

8.3.4 Deleting Logged Data

Logs stored on the slots can be deleted individually or all together.

To delete logs of a single slot:

1. Select the slot with the logs which you want to delete.
2. Tap "Clear Slot".

To delete logs on all slots:

- ▶ Tap "Clear All Slots".

8.4 Logger Settings

Access: "Logger" menu

Source
Meter ▼
Sample Rate
1 Sample/s ▼
Horizontal Scale
2 s/div ▼
Slot
Slot 1 ▼
Slot Name
Amplitudes
2017-05-10 13:51:16
Load Slot
Clear Slot
Clear All Slots

Source

Selects the logger source: "Scope", "Meter" or "Counter" (with option R&S RTH-K33).

If you change the source during running acquisition, you are asked to restart the logging. Without restart, the source remains unchanged.

Remote command:

[LOGGer : SOURce](#) on page 418

Sample Rate

Selects the number of log samples per second.

If you change the sample rate during running acquisition, you are asked to restart the logging. Without restart, the sample rate remains unchanged.

Remote command:

[LOGGer : TIMebase : SRATe](#) on page 418

Horizontal Scale

Selects the horizontal scale of the logged data.

The horizontal scale is set to "auto" by default. In this case, all logged data is always displayed.

Remote command:

[LOGGer : TIMebase : SCALe](#) on page 419

Slot

Selects one of the 10 memory slots for storing the logged data. Data is stored automatically to the selected slot if you stop the acquisition, change source or sample rate, or press PRESET. You can change the slot during recording.

If data is stored in the slot, the start time of the stored data is displayed in the menu.

Remote command:

[LOGGer: SLOT: CURRent](#) on page 419

Slot Name

Enter an optional slot name to describe the logged data. The maximum length of the name is 20 characters.

Remote command:

[LOGGer: SLOT: SLOT<m>: NAME](#) on page 419

Load Slot

Loads the stored log data of the selected slot.

Only possible while logging is stopped.

Remote command:

[LOGGer: SLOT: LOAD](#) on page 420

[LOGGer: SLOT: SLOT<m>: HASData?](#) on page 419

Clear Slot

Deletes the log data of the selected slot.

Only possible while logging is stopped.

Remote command:

[LOGGer: SLOT: CLear](#) on page 420

Clear All Slots

Deletes the log data of all slots.

Only possible while logging is stopped.

Remote command:

[LOGGer: ACLR](#) on page 420

8.5 Analyzing Logged Data

You can analyze logged data using the "Cursor" and the "Zoom". To analyze logged data at a later time, the data is stored automatically, and you can load the stored data to the display.

8.5.1 Cursor

To analyze logged data, you can use cursor measurements, see also [Chapter 4.3, "Cursor Measurements"](#), on page 88.

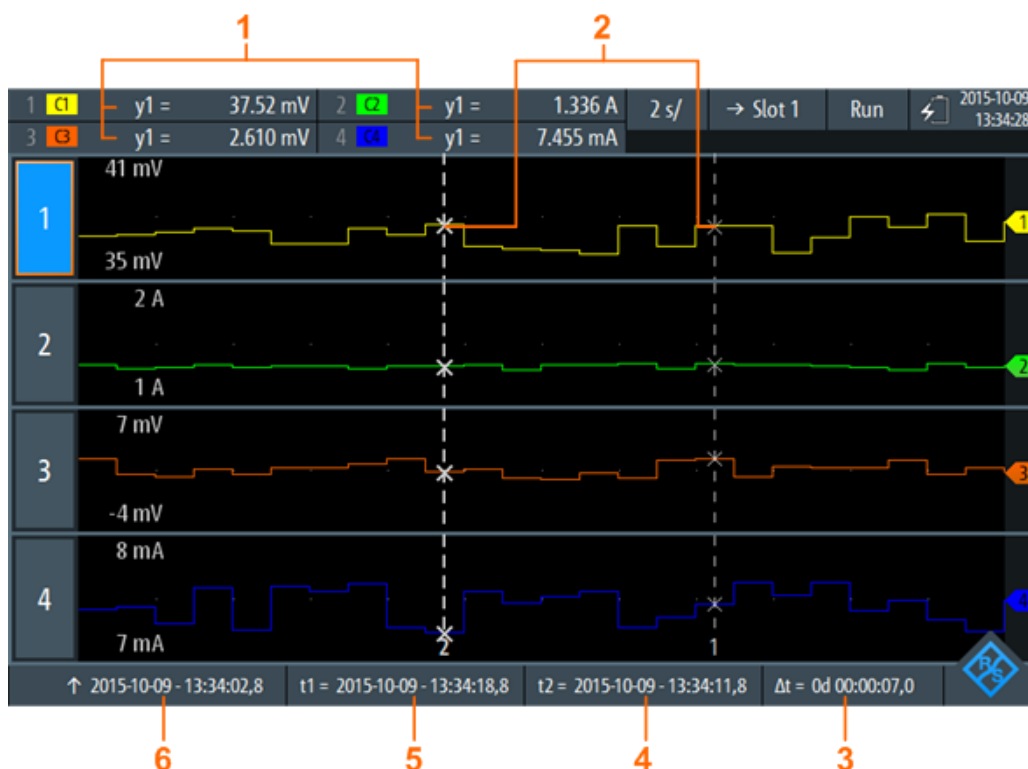

Figure 8-3: Logger display with cursors

- 1 = Values of the crossings between the selected cursor line and the waveform
- 2 = Cursor lines
- 3 = Absolute value of the time difference between the cursor lines $\Delta t = |t1-t2|$
- 4 = Position of the cursor line 2
- 5 = Position of the cursor line 1
- 6 = Time stamp of the logged signal on the left side of the display



To select one of the two cursor lines, tap a cursor line, or use the wheel to navigate and select. The selected line is highlighted by a bold line.

Remote commands for cursor results:

- `LOGGer:CURSor<m>:RESult<n>[:AMPLitude]?` on page 424
- `LOGGer:CURSor:RESult<n>:DELTA?` on page 424
- `LOGGer:CURSor<m>:POSition` on page 425
- `LOGGer:CURSor:TDELta?` on page 425



The logger cursor only allows you to set a "Cursor Value". The cursor settings "Type" and "Source" are not relevant for logging, and thus not available



Description of settings

Access: "Cursor" menu

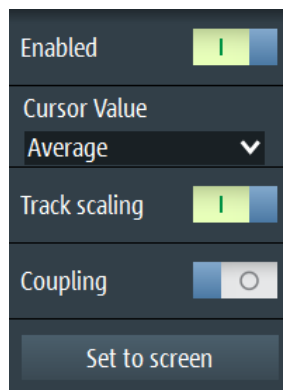

Figure 8-4: Cursor settings

Enable

Enables or disables the cursor measurement.

Remote command:

`LOGGer:CURSor[:STATe]` on page 423

Cursor Value

Sets the measured crossing point between the cursor lines and the waveform, see Figure 8-5. These settings only apply if data logging is running for more than 2 days and 7 hours. After this time, the logger compresses 4 logging values into a "Minimum", "Average" and "Maximum" value.

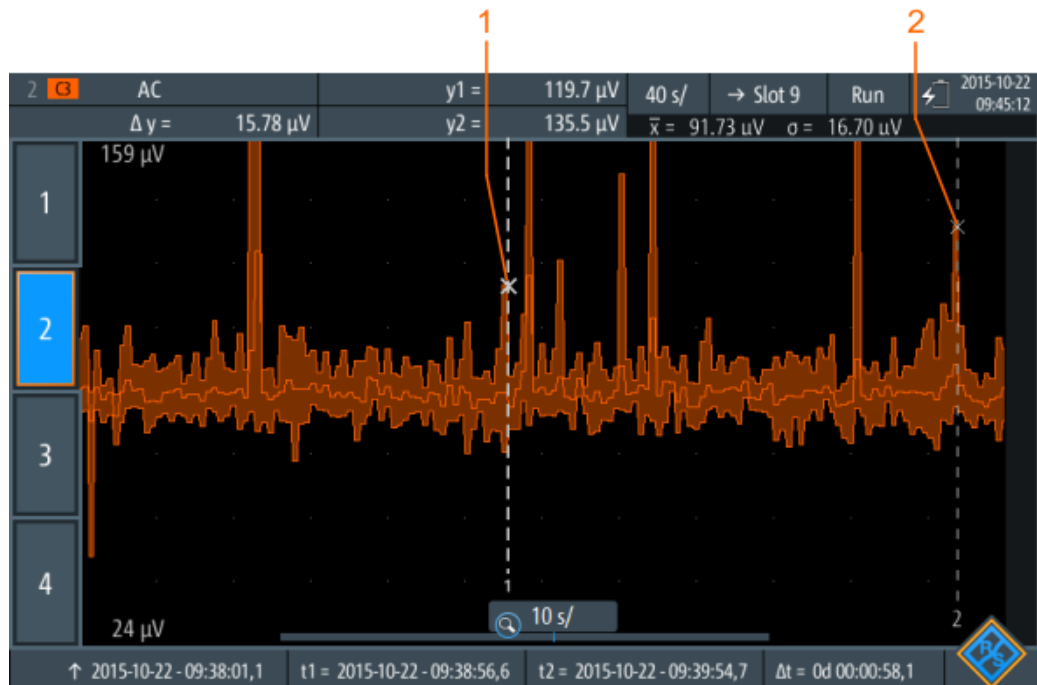

Figure 8-5: Logger cursor with summarized data

1 = Maximum value of cursor line 1

2 = Maximum value of cursor line 2

Remote command:

[LOGGer:CURSor:TYPE](#) on page 423

Track scaling

If enabled, the position of the cursor lines is adjusted if the scale is changed. The cursor lines keep their relative position to the waveform.

If disabled, the cursor lines remain on their position on the display if the scaling is changed.

Remote command:

[LOGGer:CURSor:SCPLing](#) on page 423

Coupling

Couples the cursor lines so that the distance between the two lines remains the same if one cursor is moved.

Remote command:

[LOGGer:CURSor:COUPling](#) on page 424

Set to screen

Sets the cursors to a default position on the screen. This is helpful if the cursors have disappeared from the display or need to be moved for a larger distance.

Remote command:

[LOGGer:CURSor:SCReen](#) on page 424

8.5.2 Zoom

To analyze logged data, you can use the "Zoom" function, see also [Chapter 4.1, "Zoom"](#), on page 79.



The zoom is only available if enough data have been logged.

The zoom settings in logger mode are the same as in scope mode, but the time range is much longer.

If data logging is running for more than 2 days and 7 hours, the logger compresses 4 logging values into a minimum, average and maximum value, see [Figure 8-6](#).

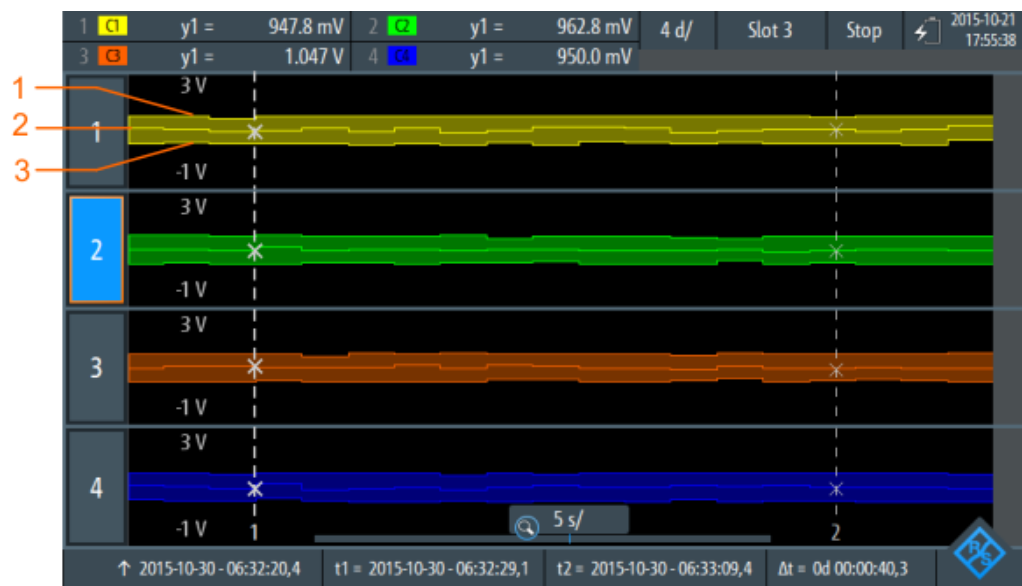

Figure 8-6: Logger zoom with summarized data

- 1 = Maximum values
- 2 = Average values
- 3 = Minimum values

☰ Description of settings

Access: "Zoom" menu

Enabled	<input checked="" type="checkbox"/>
Horizontal Scale	1 s/div
Position Time	13 : 33 : 46 . 8
Position Date	2015 / 10 / 9

Figure 8-7: Zoom settings

Enable

Turns the zoom on or off.

Remote command:

[LOGGer: ZOOM: ENABLE](#) on page 425

Horizontal Scale

Sets the horizontal scale of the horizontal axis for all logged signals, in seconds per division.

Remote command:

[LOGGer: ZOOM: SCALE](#) on page 426

Position, Position Date

Sets the position of the zoomed area in relation to the left side of the display.

Remote command:

[LOGGer:ZOOM:POSition](#) on page 426

8.5.3 Logger Statistics

Figure 8-8: Logger statistics

1 = Measurement results; display depends on the logger mode and the selected measurement

2 = Mean value statistic

3 = Standard deviation statistic

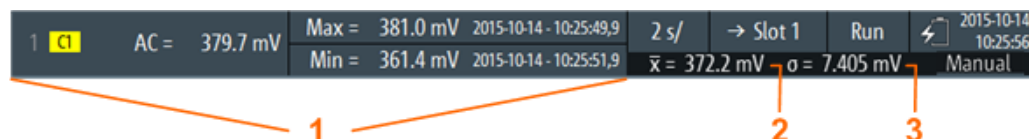

Statistics are only shown if a single log is displayed.

Remote commands for logger statistics:

- [LOGGer:RECOding:STARt?](#) on page 426
- [LOGGer:RECOding:TOTal?](#) on page 427
- [LOGGer:MEASurement<m>:RESult:CURRentsampl?](#) on page 427
- [LOGGer:MEASurement<m>:RESult:MAXimum:POSition?](#) on page 427
- [LOGGer:MEASurement<m>:RESult:MAXimum:VALue?](#) on page 427
- [LOGGer:MEASurement<m>:RESult:MINimum:POSition?](#) on page 428
- [LOGGer:MEASurement<m>:RESult:MINimum:VALue?](#) on page 428
- [LOGGer:MEASurement<m>:RESult:MEAN?](#) on page 428
- [LOGGer:MEASurement<m>:RESult:STDDev?](#) on page 428
- [LOGGer:MEASurement<m>:ENABled?](#) on page 429
- [LOGGer:MEASurement<m>:TYPE?](#) on page 429
- [LOGGer:MEASurement<m>:SOURce?](#) on page 429

8.6 Export of Logger Records

Export means to save a logger record (slot) to a CSV or MAT file for further analysis. Export is only possible if the instrument is in "Logger" mode. The instrument always saves the data of the last saved slot, you cannot select the slot to be stored.

You can also save the data of the measured waveforms when you are in logger mode. The waveform data has no time correlation to the logger data. For details of waveform export, see [Chapter 12.4, "Waveforms"](#), on page 273.

1. If data logging is running, press [RUN/STOP] to stop the logging. The logged data is saved automatically to the slot.
2. Press the [FILE] key.
3. Tap "Logger Records".
4. Tap "Export As".
5. Select the "File Type", enter the "File Name", and change the folder if necessary. If a USB flash drive is attached, the file is stored there. Otherwise, the file is stored in the `Export` folder on the microSD card.
6. Tap "Save".
The data of the last used slot is saved.

Remote commands:

- `LOGGer:SLOT:EXPort:NAME` on page 430
- `LOGGer:SLOT:EXPort:SAVE` on page 430

8.6.1 Logger Records in MATLAB

To analyze logger records in MATLAB, save the logger data in a MAT file. When you load the file in MATLAB, you see the following structure:

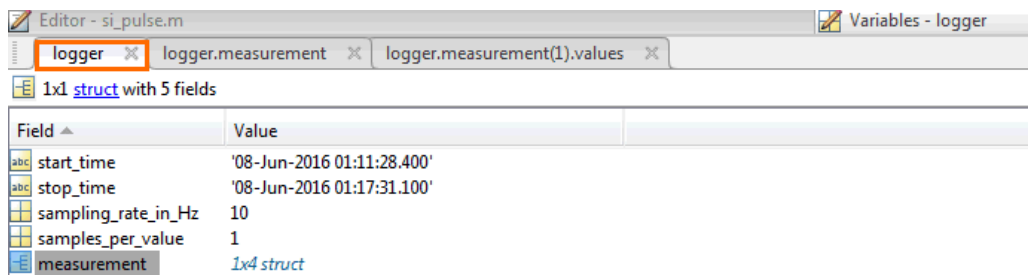

The "logger" structure contains a substructure "measurement":

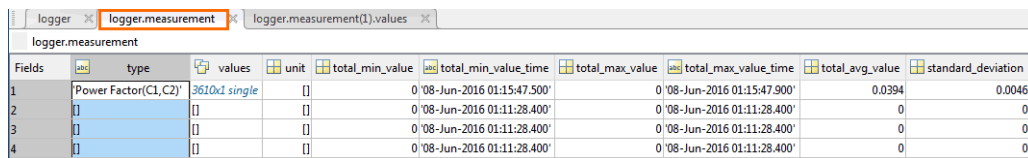

The "measurement" structure contains the values:

	1	2	3	4	5	6
1	NaN					
2	NaN					
3	NaN					
4	NaN					
5	0.0397					
6	0.0397					
7	0.0397					
8	0.0397					
9	0.0396					
10	0.0396					
11	0.0396					
12	0.0396					
13	0.0398					
14	0.0398					
15	0.0398					
16	0.0398					
17	0.0398					
18	0.0398					
19	0.0398					

Required attributes are described in [Chapter 8.6.3, "Attributes in Exported Logger Records"](#), on page 173.

Except for MATLAB, the open source software "Octave" can also read the exported MAT files. "Octave" seeks for compatibility of commands with MATLAB.

8.6.2 Logger Records in CSV Files

Logger data is saved in two CSV files. One file contains the data values and is indicated by *Wfm.* in the file name. The second file contains the header data, which is required for data analysis.

Example:

```
logger.wfm.csv
logger.csv
```

logger.wfm.csv contains the recorded data values. logger.csv contains the header data, the attributes that are required to interpret the data values.

The header file lists the attribute names and values, one attribute per row.

```
RecordedSource:Scope:
ActiveLoggerChannels:1:
...
```

The header file lists many attributes but you need only some of them. In the following figure, required attributes are marked, and most of surplus attributes are hidden. Some attributes are given for each logger channel (measurement type, unit, statistical data). The attributes of a logger channel start with `ArrayItem: Index`.

1	LoggerAttributes:	
2	RecordedSource:Scope:	
3	ActiveLoggerChannels:1:	
4	VerticalRange:Medium:	
5	VerticalNotation:Auto:	
6	SampleRate:1 Sample/s:	
7	SampleRateAsNum:1:	
8	SamplesPerValue:1:	
9	StartTime:2016,09,08,15,58,01,0:	
10	StartTimeAsNum:1473343081000:	
11	StopTime:2016,09,08,15,58,42,0:	
32	LoggerChannel:	
33	ActiveIndex:0:	
34	ArrayItem:Index:0	Logger channel 1
35	Enabled:On:	
41	TimeOfMin:2016,09,08,15,58,12,0:	
42	Minimum:0.098108962178:	
44	TimeOfMax:2016,09,08,15,58,04,0:	
45	Maximum:0.099266834557:	
46	Average:0.098667144775:	
47	StdDeviation:0.000287987496:	
64	MeasUnitAsStr:V:	
68	MeasTypeAsStr:Amplitude(C1):	
80	ArrayItem:Index:1	Logger channel 2
81	Enabled:Off:	
82	...	

Required attributes are described in [Chapter 8.6.3, "Attributes in Exported Logger Records"](#), on page 173.

8.6.3 Attributes in Exported Logger Records

The following attributes are required to interpret the exported data values.

MATLAB	CSV	Description
	ActiveLoggerChannels	Number of logger channels that recorded data
start_time	StartTime	Absolute start time of the logger record
stop_time	StopTime	Absolute end time of the logger record
sampling_rate_in_Hz	SampleRate or SampleRateAsNum	Number of log samples per second

MATLAB	CSV	Description
samples_per_value	SamplesPerValue	Compression factor. If data logging is running for more than 2 days and 7 hours, the logger compresses subsequent logging values into a "Minimum", "Average" and "Maximum" value. <i>SamplesPerValue</i> = 4 means that four values are summarized.
measurement(m)	ArrayItem:Index	Logger channel (1, 2, 3, or 4) In CSV: <i>Logger channel</i> = <i>Index</i> + 1
	Enabled	Status of the logger channel: on or off
measurement(m).type	MeasTypeAsStr	Type of the logged measurement
measurement(m).unit	MeasUnitAsStr	Unit of the logged measurement
measurement(m).total_min_value	Minimum	Lowest value of the logged data
measurement(m).total_min_value_time	TimeOfMin	Time when the minimum was measured
measurement(m).total_max_value	Maximum	Highest value of the logged data
measurement(m).total_max_value_time	TimeOfMax	Time when the maximum was measured
measurement(m).total_avg_value	Average	Average value of the logged data
measurement(m).standard_deviation	StdDeviation	Standard deviation of the logged data

9 Protocol Analysis

Using the R&S RTH and additional options, you can analyze the following serial protocols:

- [Serial Peripheral Interface \(SPI\)](#) - requires option R&S RTH-K1
- [Inter-Integrated circuit bus \(I²C\)](#) - requires option R&S RTH-K1
- [UART / RS-232 / RS-422 / RS-485 interfaces](#) - require option R&S RTH-K2
- [Controller Area Network \(CAN\)](#) - requires option R&S RTH-K3
- [CAN with flexible data rate \(CAN FD\)](#) - requires option R&S RTH-K9
- [Local Interconnect Network \(LIN\)](#) - requires option R&S RTH-K3
- [Single Edge Nibble Transmission \(SENT\)](#) - requires option R&S RTH-K10

The analysis of serial data consists of three main steps:

- **Protocol configuration:**
Select the protocol type, and configure the input line as well as the protocol-specific settings.
- **Decoding:**
Select the display format of the decoded data. The digitized signal data is displayed on the screen together with the decoded content of the messages in combs. You can scale the signal display and zoom into it to see it in more detail. You can list the decoded results in tabular form in the "Protocol" mode, and display selected frames.
- **Triggering:**
You can trigger on various events that are typical for the configured bus type, for example, on start and stop of messages, or on data patterns.

Analysis is performed on analog input channels. The instrument uses the threshold to convert the analog signal into a logic signal. If MSO option R&S RTH-B1 is installed, you can also analyze logic channels.

9.1 Basics of Protocol Analysis

This chapter explains in general:

- Configuration of serial bus signals for decoding,
- Display of decoded data and their usage for analysis,
- Usage of symbolic address names (label lists).

9.1.1 General Protocol Settings

Access: "Bus" menu

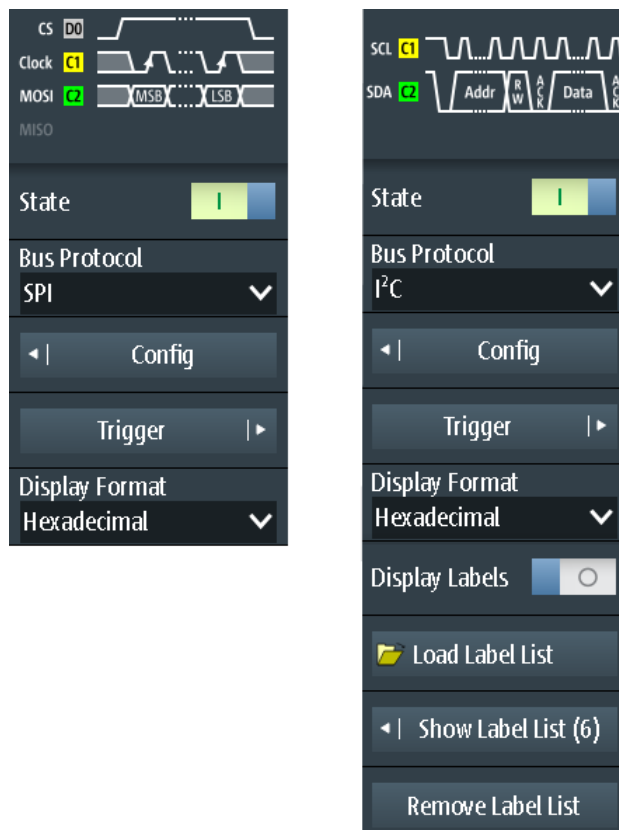

Figure 9-1: Bus menu. Left: for protocols without address (SPI, UART). Right: for protocols with address or identifier (I²C, CAN, LIN, SENT)

For all serial protocols, the following settings are required:

State

Enables the decoding and the display of the serial bus data.

Remote command:

[BUS\[:STATe\]](#) on page 431

Bus Protocol

Defines protocol type of the bus for configuration and trigger settings.

Remote command:

[BUS:TYPE](#) on page 431

Display Format

Sets the decoding format of data values: binary, hexadecimal, decimal, octal, or ASCII. The format is used in comb display and in the protocol table. Address values are always hex values.

Remote command:

[BUS:FORMat](#) on page 431

Display Labels

Activates the last loaded label list and shows the label in the decoding results (comb display and protocol table).

Symbolic Decode ← Display Labels

Only available for CAN protocols if DBC file is loaded.

If disabled, only the message names are shown in the comb display of the decoded data. If enabled, the signal labels are shown in addition.

Load Label List

Selects and loads a label list file.

Label lists are protocol-specific. Their contents are described in the corresponding protocol chapters:

- [Chapter 9.2.4, "I²C Label List"](#), on page 188
- [Chapter 9.5.4, "CAN Label List"](#), on page 216
- [Chapter 9.6.4, "LIN Label List"](#), on page 226
- [Chapter 9.7.4, "SENT Label List"](#), on page 240

Show Label List

Shows the content of the label list file in a window.

Remove Label List

Disables the loaded label list.

9.1.2 Decode Results

When the configuration of the serial bus is complete, the instrument can decode the signal. The decode results are displayed in two ways:

- In "Scope" mode, the bus signal is shown as combs, together with the time-correlated input signals. The combs show the address and data values.
- In "Protocol" mode, detailed results are listed in a table. The table provides data values and time information of the frames or words.

9.1.2.1 Decoded Signal in Scope Mode**To decode the serial bus**

- ▶ In the "Bus" menu, enable "State".

The bus signal is shown in a comb display. The colors of the combs are protocol-specific and described in the "Decode Results" chapters of the protocol description.



Figure 9-2: Comb display of a decoded CAN signal

To adjust the scaling of the decoded bus signal in scope mode

1. The horizontal size of the combs is defined by the horizontal time scale, which is the same for input signals and the bus signal. Press the [TIME] keys to change the time scale.
2. The vertical size is specific for the bus signal.
 - a) Tap the bus signal to set the focus.
 - b) Press the [RANGE] keys.

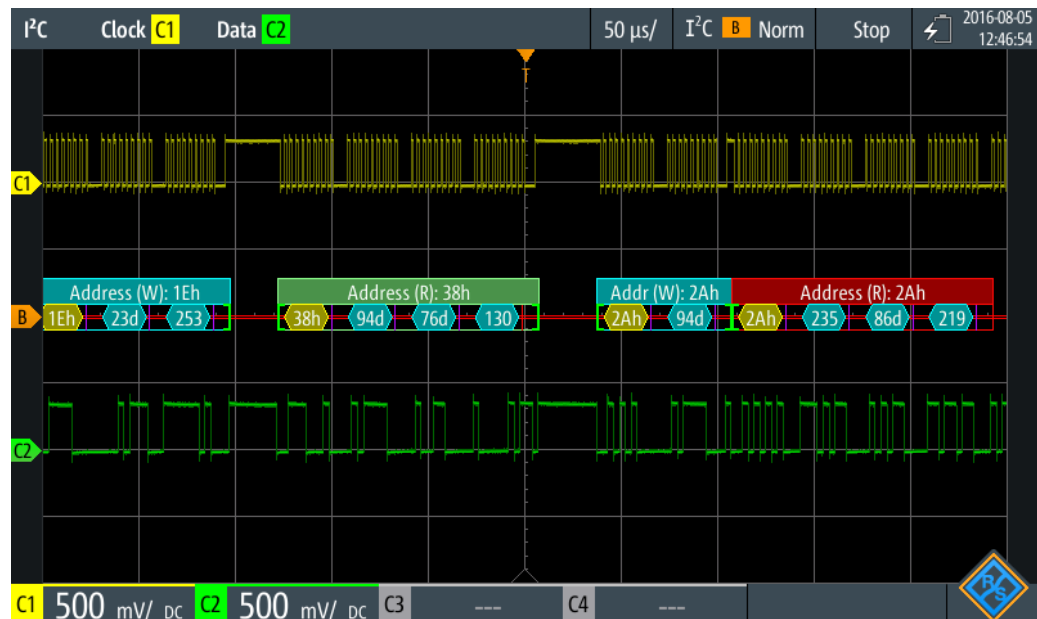

Figure 9-3: Decoded I2C signal in scope mode, Display Format for data is decimal

9.1.2.2 Decoded Signal in Protocol Mode

In "Protocol" mode, you see the results in a table, and the signal combs below the table. Each table row contains the information of one frame.

All menus that are relevant for protocol analysis are available, in particular, the "Bus" and "Trigger" menus. Thus, you can adjust the settings without changing the mode. In addition, a "Protocol" menu is available.

1. Press the [MODE] key.
2. Select the "Protocol" mode.

The result table is shown. The contents is protocol-specific and described in the "Decode Results" chapters of the protocol description.

3. To show the complete frame information, tap the row.

A window with values and time data of the selected row opens.

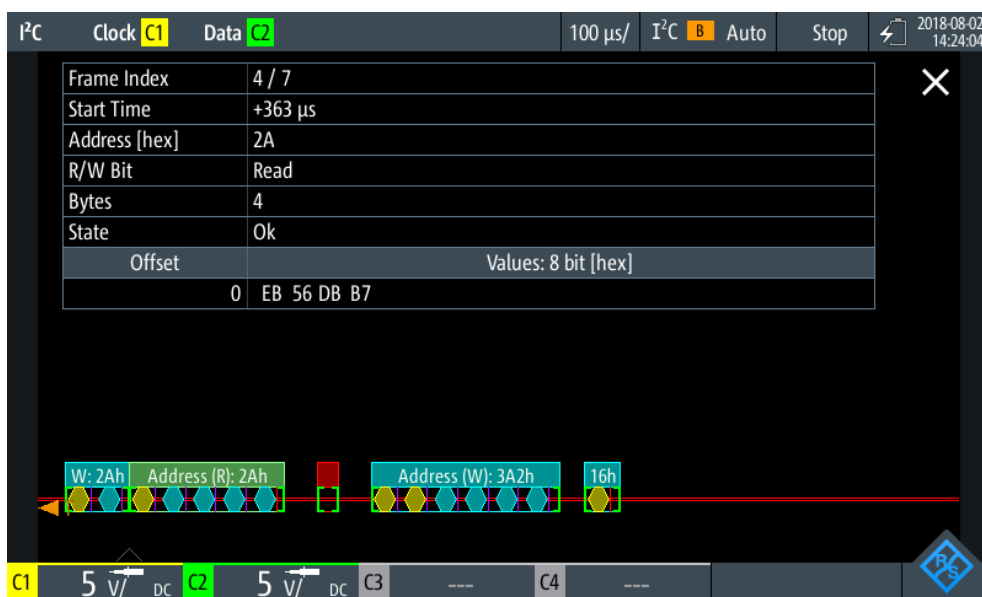

Figure 9-4: Decoded I2C signal, details of frame no. 4

4. To close the frame window, tap the "Close" icon in the upper right corner of the window.
5. To synchronize the selected row with the comb display:
 - a) Open the "Protocol" menu.
 - b) Enable "Track in Table".

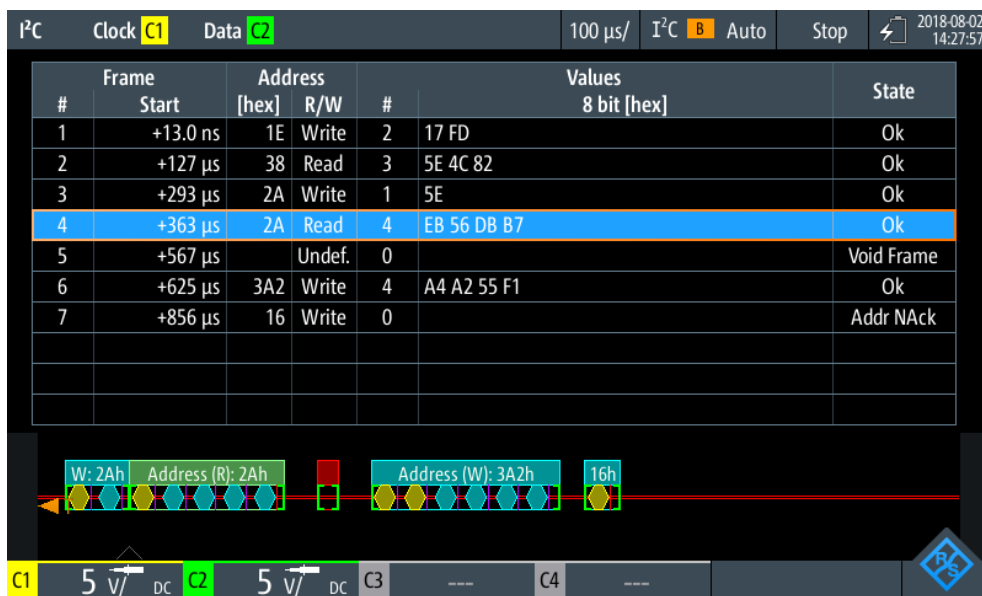

Figure 9-5: Decoded I2C signal with active Track in Table, and reference point set to the left.

6. To see the comb of the selected frame in more detail, enable "Zoom Coupling" in the "Protocol" menu.

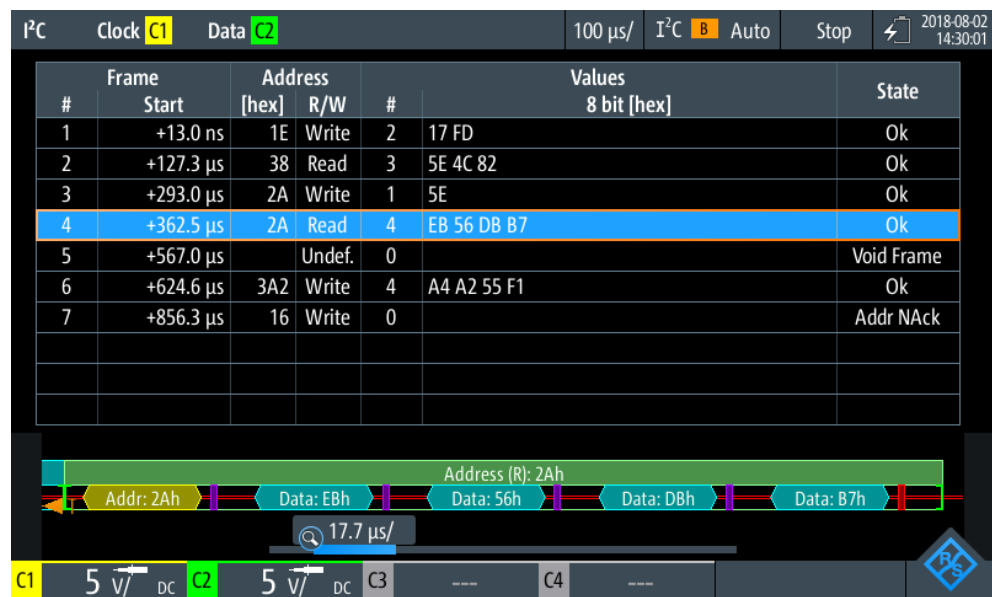
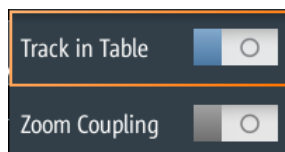

Figure 9-6: Decoded I2C signal, zoom into selected frame

9.1.2.3 Settings in the Protocol Menu

Access: "Protocol" menu



Track in Table

Sets the start of the selected frame (selected row) to the reference point.

Zoom Coupling

The setting is only available if "Track in Table" is active. It shows the comb of the selected frame on full width of the screen. The resulting zoom time scale is shown below the comb.

9.1.3 Label Lists

For all protocols using ID or address identification, it is possible to create label lists containing addresses or IDs, a symbolic name for each node (symbolic label), and some protocol-specific information.

You can load label lists, and activate its usage for decoding. As a result, an additional "Label" column appears in the "Decode results" table, containing the symbolic label. The frame captions of the decoded signal show the symbolic label instead of the ID or address values. Hence it is easy to identify the messages of the different bus nodes.

You can also use the label list to trigger on an identifier or address. Instead of entering the value, you select the name, which is defined in the label list.

Available file formats are PTT, CSV, and DBC (CAN only).

Label lists are protocol-specific. Their contents are described in the corresponding protocol chapters:

- [Chapter 9.2.4, "I²C Label List"](#), on page 188
- [Chapter 9.5.4, "CAN Label List"](#), on page 216
- [Chapter 9.6.4, "LIN Label List"](#), on page 226
- [Chapter 9.7.4, "SENT Label List"](#), on page 240

9.1.3.1 Using Label Lists

To load a label list and display the labels:

1. Save the label list file on a USB flash drive, or on the microSD card.
2. Press and hold the [BUS] key until the menu opens.
3. Configure the protocol.
4. In the "Bus" menu, tap "Load Label List".
5. Navigate to the label list file, select it, and tap "Select".
6. To read the label list, tap "Show Label List".
7. To use the labels in the display of the decoded data, tap "Display Labels".

To trigger on an identifier or address using the label:

Prerequisites: The bus is configured, decoding is enabled, and a decoded signal is visible.

1. Open the "Trigger" menu.
2. Set the following trigger settings:
 - "Trigger Mode" = "Normal"
 - "Trigger Type" = "Bus"
 - "<Protocol> Trigger" = "Identifier", or "Identifier + Data", or "Address", or "Address and Data".
3. Tap "Identifier from Label" or "Address from Label".
4. Select the label. Tap "Back".

If the selected identifier or address is available in the acquired data, its value is shown in the menu, and the instrument triggers on it.

9.1.3.2 Content and Format of the PTT File

Label lists are stored as PTT (protocol translation table) files. The PTT file format is an extension of the CSV format (comma-separated values). You can edit it with standard editors, for example, with MS Excel or a text editor.

The PTT file has three types of lines:

- Comment lines begin with a hash character #. A hash character at any other position in the line is treated like a standard character.
- Command lines begin with a commercial at character @. An @ character at any other position in the line is treated like a standard character.
- Standard lines are the lines that not qualify as comment or command lines. They build the core of the label list.

Command lines

Command lines define the version of the PTT file and the protocol name:

- @FILE_VERSION: must appear exactly once in the file
- @PROTOCOL_NAME: must appear at least once in the file. Thus, one file can contain several label lists for different protocols.

```
# --- Start of PTT file
@FILE_VERSION = 1.0
@PROTOCOL_NAME = i2c
[... Label list for I2C]
@PROTOCOL_NAME = can
[... Label list for CAN]
# --- End of PTT file
```

Standard lines

Standard lines define the contents of the label list. The rules for standard lines follow the csv convention, they are:

- Values are separated by commas
- Space characters following a delimiter are ignored
- Values with a special character (comma, newline, or double quote) must be enclosed in double quotes
- Text in double quotes must be escaped by double quote characters

The format of the numeric value is indicated by a suffix. The following formats are supported:

Format	Suffix	Example
Decimal	<empty> d	106, DeviceName 106d, DeviceName
Hexadecimal	h	6Ah, DeviceName or prefix: 0x6A, DeviceName

Format	Suffix	Example
Octal	o	152o, DeviceName
Binary	b	01101010b, DeviceName

The maximum supported word size for (unsigned) integers is 64 bits.

```
# --- Start of PTT file
@FILE_VERSION = 1.0
@PROTOCOL_NAME = i2c
#   Following two lines are equal:
7,01h, Temperature
7,01h, Temperature
#   A comma must be enclosed in double quotes:
7,01h, "Temperature, Pressure, and Volume"
#   A double quote must also be enclosed in double quotes:
7,7Fh, "Highspeed ""Master"" 01"
#   Following lines yield the same result:
7d,0x11, Pressure
7h,11h, Pressure
0x7,17d, Pressure
7,17, Pressure
```

9.2 I2C (Option R&S RTH-K1)

9.2.1 The I²C Protocol

This chapter provides an overview of protocol characteristics, data format, address types and trigger possibilities. For detailed information, read the "I2C-bus specification and user manual" available on the NXP manuals web page at <http://www.nxp.com/>.

I²C characteristics

Main characteristics of I²C are:

- Two-wire design: serial clock (SCL) and serial data (SDA) lines
- Master-slave communication: the master generates the clock and addresses the slaves. Slaves receive the address and the clock. Both master and slaves can transmit and receive data.
- Addressing scheme: each slave device is addressable by a unique address. Multiple slave devices can be linked together and can be addressed by the same master.
- Read/write bit: specifies if the master reads (=1) or writes (=0) the data.
- Acknowledge: takes place after every byte. The receiver of the address or data sends the acknowledge bit to the transmitter.

The R&S RTH supports all operating speed modes: high-speed, fast mode plus, fast mode, and standard mode.

Data transfer

The format of a simple I²C message (frame) with 7-bit addressing consists of the following parts:

- Start condition: a falling slope on SDA while SCL is high
- 7-bit address of the slave device that either is written to or read from
- R/W bit: specifies if the data is written to or read from the slave
- ACKnowledge bits: is issued by the receiver of the previous byte if the transfer was successful
Exception: At read access, the master terminates the data transmission with a NACK bit after the last byte.
- Data: several data bytes with an ACK bit after every byte
- Stop condition: a rising slope on SDA while SCL is high

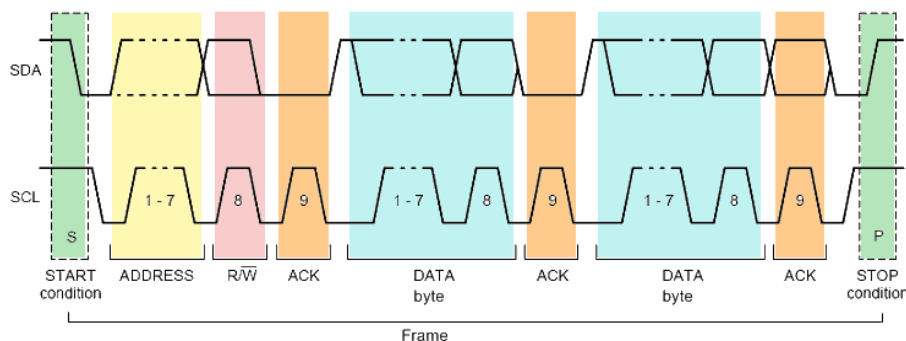

Figure 9-7: I2C writes access with 7-bit address

Address types: 7-bit and 10-bit

Slave addresses can be 7 bits or 10 bits long. A 7-bit address requires 1 byte, 7 bits for the address followed by the R/W bit.

A 10-bit address for write access requires 2 bytes: the first byte starts with the reserved sequence 11110, followed by the two MSB of the address and the write bit. The second byte contains the remaining 8 LSB of the address. The slave acknowledges each address byte.

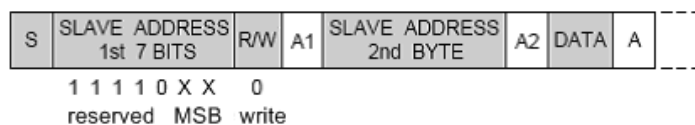

Figure 9-8: 10-bit address, write access

A 10-bit address for read access requires 3 bytes. The first 2 bytes are identical to the write access address. The third byte repeats the address bits of the first byte and sets the read bit.

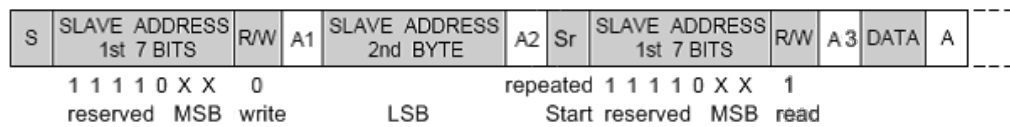

Figure 9-9: 10-bit address, read access

Trigger

The R&S RTH can trigger on various parts of I²C messages. The data and clock lines must be connected to the input channels, triggering on math and reference waveforms is not possible.

You can trigger on:

- Start or stop condition
- Repeated start condition
- Transfer direction (read or write)
- Bytes with missing acknowledge bit
- Specific slave address
- Specific data pattern in the message

9.2.2 I2C Configuration Settings

Access: "Bus" menu > "Bus Protocol" = "I2C" > "Config"

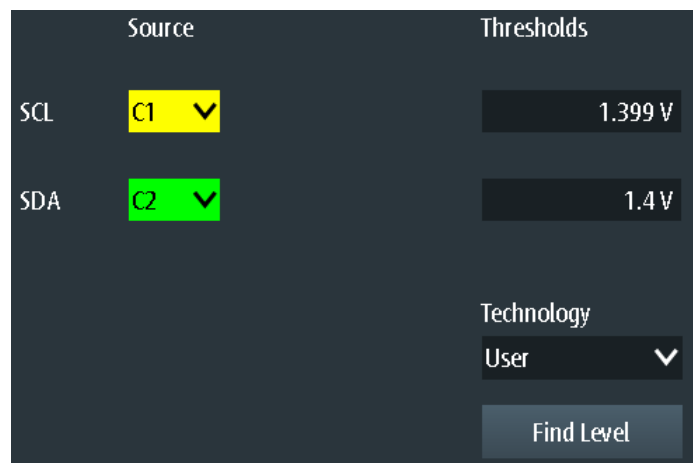

SCL, SDA

Set the input source of the data line (SDA) and clock line (SCL).

If option R&S RTH-B1 is installed, digital channels can also be used as source.

Remote command:

[BUS:I2C:SCL:SOURce](#) on page 432

[BUS:I2C:SDA:SOURce](#) on page 432

Thresholds, Technology, Find Level

Sets the threshold value for digitization of signals. If the signal value is higher than the threshold, the signal state is high. Otherwise, the signal state is considered low.

You can select the threshold voltages for various types of integrated circuits in the "Technology" list, or set a user-defined value in "Thresholds". You can also let the instrument set the appropriate threshold using "Find Level".

Changing the thresholds in the bus configuration changes also the thresholds of analog channels in the "Vertical" menu, or the thresholds of logic channels in the "Logic" menu.

Remote command:

`BUS:I2C:TECHnology` on page 432

`BUS:I2C:SCL:THReshold` on page 432

`BUS:I2C:SDA:THReshold` on page 432

`BUS:SETReflevels` on page 432

`CHANnel<m>:THReshold:FINDlevel` on page 310

9.2.3 I2C Trigger Settings

Access: "Bus" menu > "Bus Protocol" = "I2C" > "Trigger"

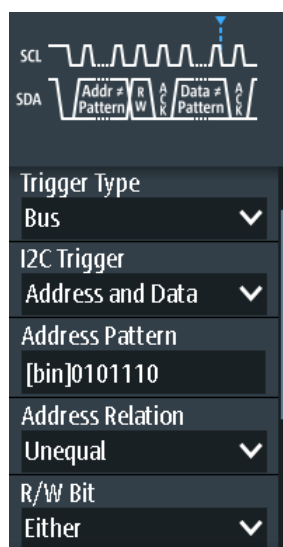
**I2C Trigger**

Selects the trigger type for I²C analysis.

- | | |
|-----------|---|
| "Start" | Sets the trigger to the start of the message. The start condition is a falling edge on SDA while SCL is high. The trigger instant is the falling edge of the SDA line. |
| "Restart" | Sets the trigger to a restart - when the start condition occurs without previous stop condition. Restart conditions occur when a master exchanges multiple messages with a slave without releasing the bus. |
| "Stop" | Sets the trigger to the end of the message. The stop condition is a rising slope on SDA while SCL is high. |

"No Ack (Missing Ack)"

Missing acknowledge bit: the instrument triggers if the data line remains HIGH during the clock pulse following a transmitted byte. You can also localize specific missing acknowledge bits by setting the [No Ack \(Missing Ack\)](#) bits.

"Address"

Sets the trigger to one specific address pattern that is expected. The trigger time is the falling clock edge of the acknowledge bit after the address.

"Data"

Sets the trigger to a specified data pattern that is expected.

"Address and Data"

Sets the trigger to a combination of address and data condition.

Remote command:

[TRIGger:I2C:MODE](#) on page 433

No Ack (Missing Ack)

Selects which missing acknowledge bits is detected if the trigger type is set to "No Ack (Missing Ack)".

"Address NACK"

No slave recognizes the address.

"Data Read NACK"

Marks the end of the read process when the master reads data from the slave. This Nack is sent according to the protocol definition, it is not an error.

"Data Write NACK"

The addressed slave does not accept the written data.

Remote command:

[TRIGger:I2C:ADNack](#) on page 433

[TRIGger:I2C:DRNack](#) on page 433

[TRIGger:I2C:DWNack](#) on page 433

Address Pattern

Specifies the address pattern to be found, in binary or hex format. Enter the pattern in MSB first bit order.

See also [Chapter 3.6.12.1, "Pattern Definition"](#), on page 72.

Remote command:

[TRIGger:I2C:ADDRess](#) on page 434

Address Relation

Defines how the specified serial address pattern is compared with the acquired signal. The instrument triggers if the acquired address is equal or unequal the defined pattern.

Remote command:

[TRIGger:I2C:ACONdition](#) on page 434

R/W Bit

Toggles the trigger condition between read and write access of the master. Select "Either" if the transfer direction is not relevant for the trigger condition.

Remote command:

`TRIGger:I2C:ACcEss` on page 434

Data Pattern

Specifies the data pattern to be found on the specified line, in binary or hex format. Enter the words in MSB first bit order.

See also [Chapter 3.6.12.1, "Pattern Definition"](#), on page 72.

Remote command:

`TRIGger:I2C:DATA` on page 434

Data Relation

Sets how the defined serial data pattern is compared with the acquired signal. The instrument triggers if the acquired data pattern is equal or unequal the defined pattern.

Remote command:

`TRIGger:I2C:DcONdition` on page 435

Byte Offset

Sets the number of bytes before the first byte of the data pattern. These bytes are ignored.

Remote command:

`TRIGger:I2C:DPOsition` on page 435

9.2.4 I²C Label List

Label lists are protocol-specific. Label lists for I²C are available in CSV and PTT format.

An I²C label file contains three values for each address:

- Address type, 7-bit or 10-bit long
- Address value
- Symbolic label: name of the address, specifying its function in the bus network.

Example: I²C PTT file

```
# -----
@FILE_VERSION = 1.00
@PROTOCOL_NAME = i2c
# -----
# Labels for I2C protocol
# Column order: Identifier type, Identifier value, Label
# -----
7,0x1E,Voltage
7,38h,Pressure
7,2Ah,Temperature
7,16h,Speed
```



```

7,118,Acceleration
7,07h,HighSpeed_Master_0x3
7,51h,EEPROM
10,3A2h,DeviceSetup
10,1A3h,GatewayStatus
10,06Eh,LeftSensor
# -----

```

For general information on label lists, see [Chapter 9.1.3, "Label Lists"](#), on page 180.

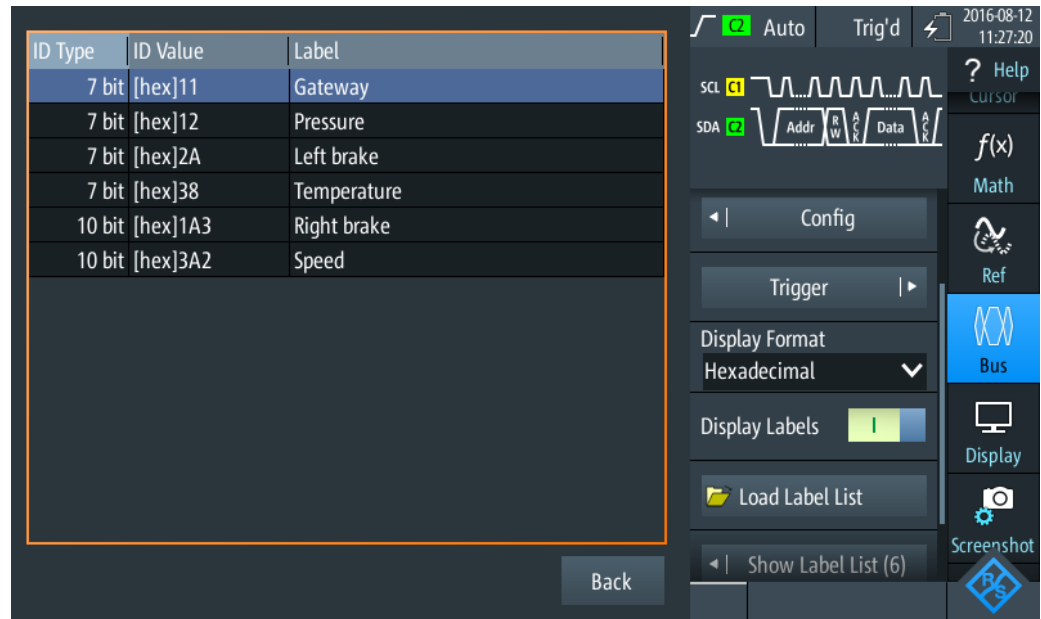

Figure 9-10: Display of an I²C label list

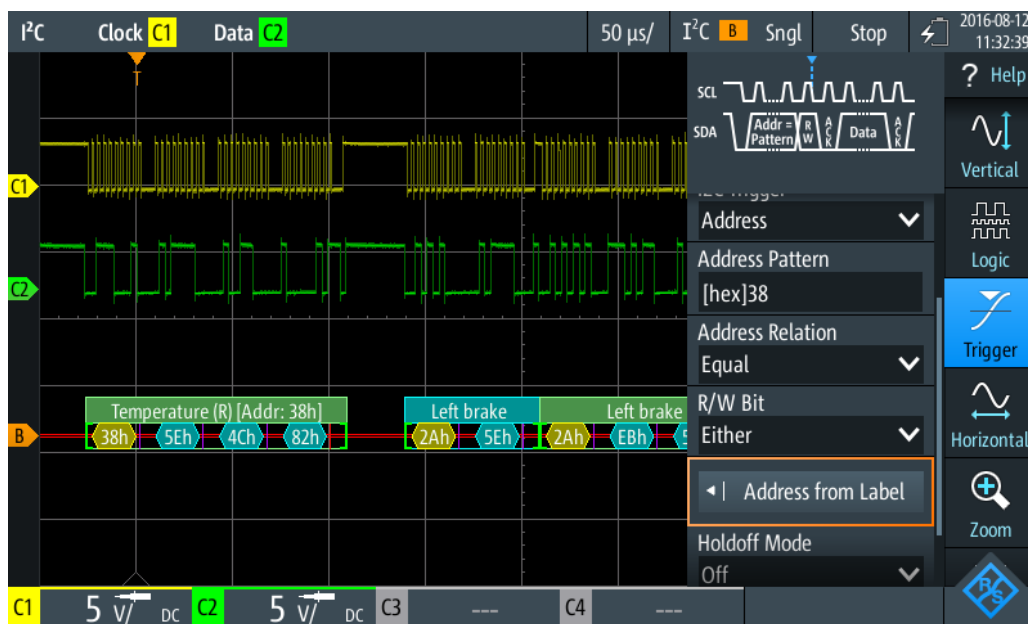

Figure 9-11: Trigger on address "Temperature", value 38 (hex)

9.2.5 I2C Decode Results

This chapter describes the comb display and the decode results table of decoded I2C buses. Basic information on decoding and display of decode results is given in [Chapter 9.1.2, "Decode Results"](#), on page 177.

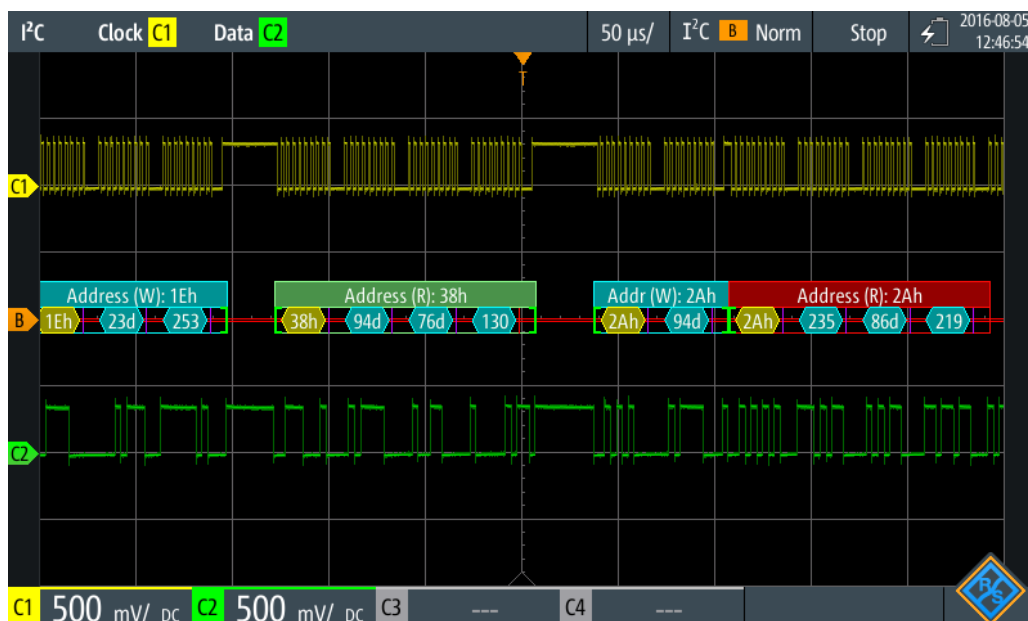

Figure 9-12: Comb display of a decoded I2C signal, triggered on a missing acknowledge bit

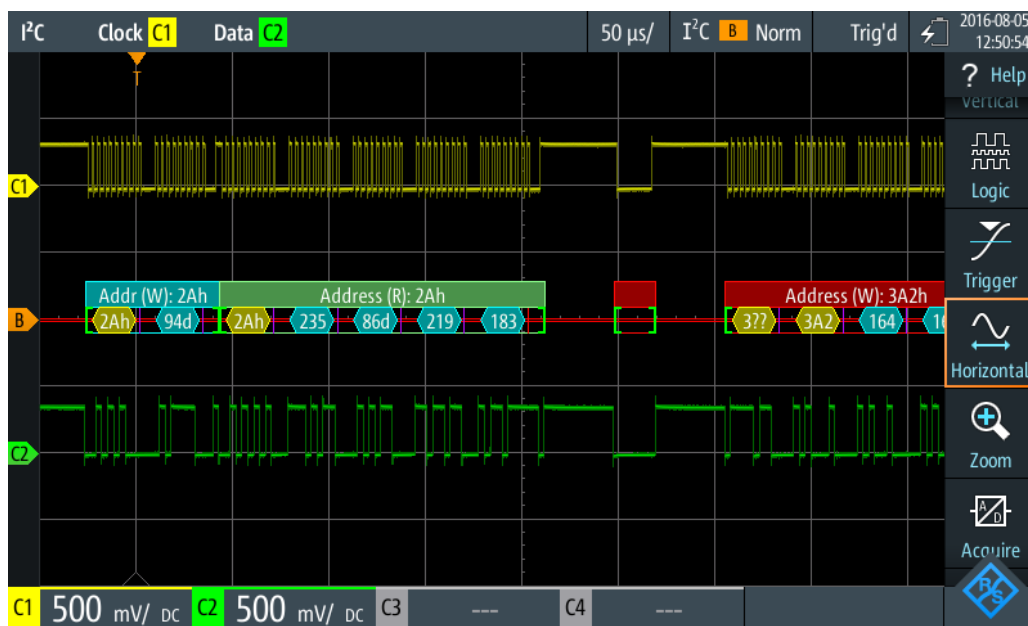

Figure 9-13: Comb display of a decoded I2C signal, triggered on address 2A (hex)

The color-coding of the various protocol sections and errors simplifies the interpretation of the visual display.

Table 9-1: Color codes of decoded I2C signals

Color, display element	Description
Green brackets [...]	Start and end of frame
Green frame header	Read frame. Text indicates transfer direction (R = read) and address of the frame (hex)
Cyan frame header	Write frame. Text indicates transfer direction (W = write) and address of the frame (hex)
Yellow comb	Address
Cyan comb	Data bytes
Violet	Acknowledge bit
Red	Missing acknowledge bit, error in frame, insufficient frame (end of acquisition before decoding has been completed)

In "Protocol" mode, decoded data is shown in tabular form.

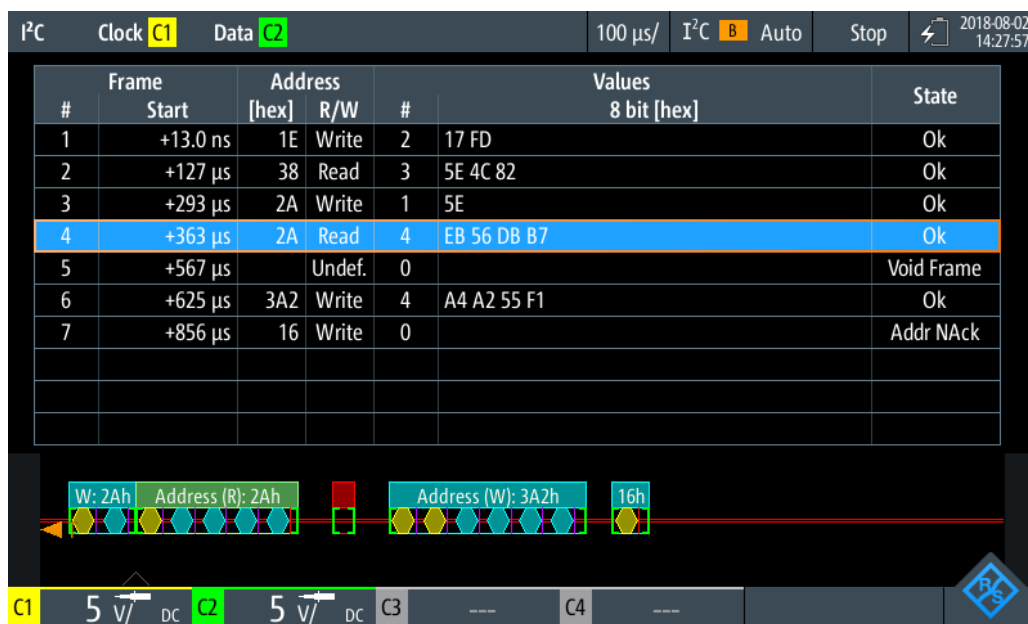

Figure 9-14: Decoded I2C signal in Protocol mode

Table 9-2: Content of the protocol table for decoded I2C signal

Column	Description
#	Frame index
Frame Start	Time of frame start
Address [hex]	Hexadecimal value of the address
Address R/W	Value of the R/W bit
Values 8 bit [format]	Value of data byte. The data format is selected in the "Bus" menu.
State	Overall state of the frame. "Incomplete" indicates that the frame is not completely contained in the acquisition. Change the time scale, or move the reference point to the left to get a longer acquisition.

Remote commands are described in [Chapter 15.11.2.3, "I2C Decode Results"](#), on page 435.

9.3 SPI (Option R&S RTH-K1)

9.3.1 The SPI Protocol

A 4-channel instrument is required for full support of the SPI protocol, or the MSO option R&S RTH-B1.

The Serial Peripheral Interface SPI is used for communication with slow peripheral devices, in particular, for transmission of data streams.

Main characteristics of SPI are:

- Master-slave communication
- No device addressing; The slave is accessed by a chip select, or slave select line.
- No acknowledgement mechanism to confirm receipt of data
- Duplex capability

Most SPI buses have four lines, two data and two control lines:

- Clock line to all slaves (SCLK)
- Slave Select or Chip Select line (SS or CS)
- Master data output, slave data input (MOSI or SDI)
- Master data input, slave data output (MISO or SDO)

When the master generates a clock and selects a slave device, data may be transferred in either or both directions simultaneously.

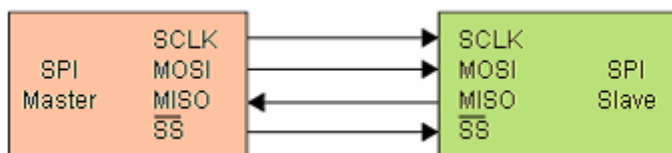

Figure 9-15: Simple configuration of SPI bus

The data bits of a message are grouped by following criteria:

- A word contains a number of successive bits. The word length is defined in the protocol configuration.
- A frame contains a number of successive words, at least one word.

For SPI buses, the R&S RTH provides the following trigger possibilities:

- On frame start
- On frame end
- On a serial pattern at a specified position

9.3.2 SPI Configuration Settings

Access: "Bus" menu > "Bus Protocol" = "SPI" > "Config"

	Source	Polarity	Thresholds
CS	None	Active high	1.4 V
Clock	C1	Rising	1.399 V
MOSI	C2		1.4 V
MISO	None		1.4 V
Word Length	8 bit	Bit Order	Technology
		MSB First	User
Frame Timeout			Find Level
	1 ms		

Source: CS, Clock, MOSI, MISO

Set the input channels of the SPI lines.

If option R&S RTH-B1 is installed, digital channels can also be used as source.

Remote command:

[BUS:SPI:SSEL:SOURce](#) on page 442

[BUS:SPI:SCLK:SOURce](#) on page 442

[BUS:SPI:MISO:SOURce](#) on page 442

[BUS:SPI:MOSI:SOURce](#) on page 442

Polarity

Selects whether the chip select signal is high active (high = 1) or low active (low = 1).

Remote command:

[BUS:SPI:SSEL:POLarity](#) on page 442

Slope

Selects if data are sampled on the rising or falling slope of the clock. The clock slope marks the begin of a new bit.

Remote command:

[BUS:SPI:SCLK:SLOPe](#) on page 442

Thresholds, Technology, Find Level

Sets the threshold value for digitization of signals. If the signal value is higher than the threshold, the signal state is high. Otherwise, the signal state is considered low.

You can select the threshold voltage on all lines for various types of integrated circuits in the "Technology" list, or set a user-defined value for each line in "Thresholds". You can also let the instrument set the appropriate thresholds using "Find Level".

Changing the thresholds in the bus configuration changes also the thresholds of analog channels in the "Vertical" menu, or the thresholds of logic channels in the "Logic" menu.

Remote command:

[BUS:SPI:TECHnology](#) on page 442

[BUS:SPI:SSEL:THReshold](#) on page 443

[BUS:SPI:SCLK:THReshold](#) on page 443

[BUS:SPI:MISO:THReshold](#) on page 443

[BUS:SPI:MOSI:THReshold](#) on page 443

[BUS:SETReflevels](#) on page 432

[CHANnel<m>:THReshold:FINDlevel](#) on page 310

Word Length

Sets the number of bits in a word. The maximum length is 32 bit.

Remote command:

[BUS:SPI:WSIZE](#) on page 443

Bit Order

Defines if the data of the words starts with MSB (most significant bit) or LSB (least significant bit). The display of the decoded signal considers this setting, results are displayed in the specified order.

Remote command:

[BUS:SPI:ORDer](#) on page 443

Frame Timeout

Sets the minimum idle time between two data frames. If the time interval between the data frames is shorter, the words are part of the same frame. Within the timeout, the data and clock lines are low. A new frame begins when the timeout has expired.

Timeout is only relevant if the bus has no chip select.

Remote command:

[BUS:SPI:TIMEout](#) on page 444

9.3.3 SPI Trigger Settings

Access: "Bus" menu > "Bus Protocol" = "SPI" > "Trigger"



SPI Trigger

Selects the trigger type for SPI analysis.

- "Frame Start" Sets the trigger to the start of the message. If the bus has a CS line, the frame starts when the chip select signal changes to the active state. Without CS line, the frame starts when the idle time has expired.
- "Frame End" Sets the trigger to the end of the message. If the bus has a CS line, the frame ends when the chip select signal changes to the inactive state. Without CS line, the frame ends when the idle time has expired after the last clock and no new clock appeared during that time.
- "Data" Sets the trigger to a specified bit pattern that is expected on one of the lines.

Remote command:

[TRIGger:SPI:MODE](#) on page 444

Datasource

Selects the line, on which the trigger pattern is expected.

Remote command:

[TRIGger:SPI:DSRC](#) on page 444

Pattern

Specifies the data pattern to be found on the specified line, in binary or hex format. Enter the words in MSB first bit order.

See also [Chapter 3.6.12.1, "Pattern Definition"](#), on page 72.

Remote command:

[TRIGger:SPI:DATA](#) on page 445

Relation

Defines how the defined serial data pattern is compared with the acquired signal. The instrument triggers if the acquired data word is equal or unequal the defined pattern.

Remote command:

`TRIGger:SPI:DCONdition` on page 445

Bit Offset

Sets the number of bits before the first bit of the pattern. These bits are ignored. The first bit after CS or timeout is bit 0. For example, with bit offset = 2, bit 0 and bit 1 after CS are ignored, and the pattern starts with bit 2.

Remote command:

`TRIGger:SPI:DPOSition` on page 445

Chip Select

Defines if the SPI bus uses a chip select line or not.

Remote command:

`BUS:SPI:SSEL:STATe` on page 444

9.3.4 SPI Decode Results

This chapter describes the comb display and the decode results table of decoded SPI buses. Basic information on decoding and display of decode results is given in [Chapter 9.1.2, "Decode Results"](#), on page 177.

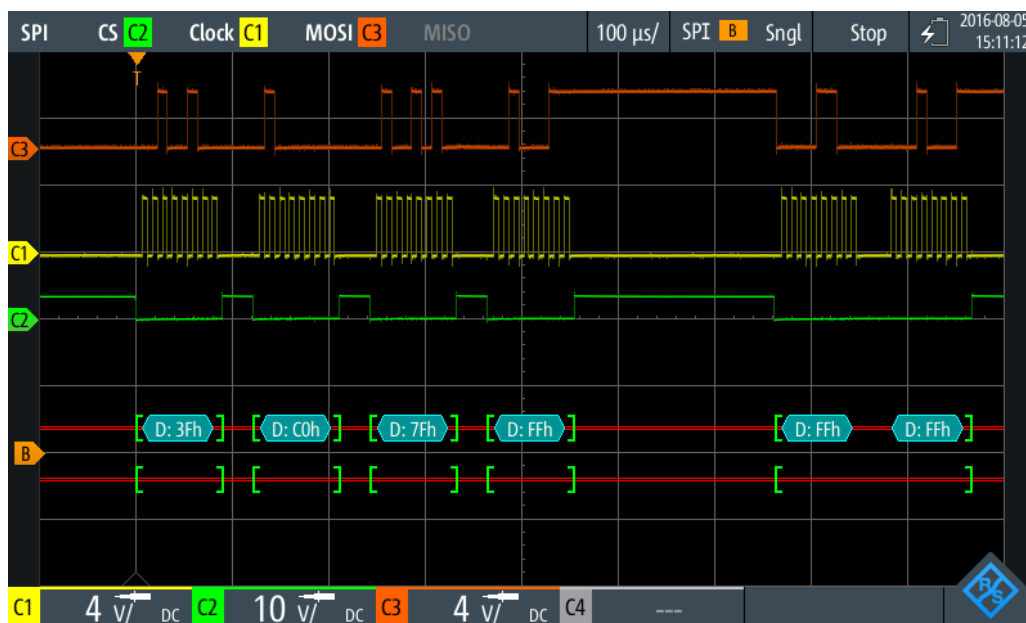

Figure 9-16: Comb display of a decoded SPI signal, triggered on frame start

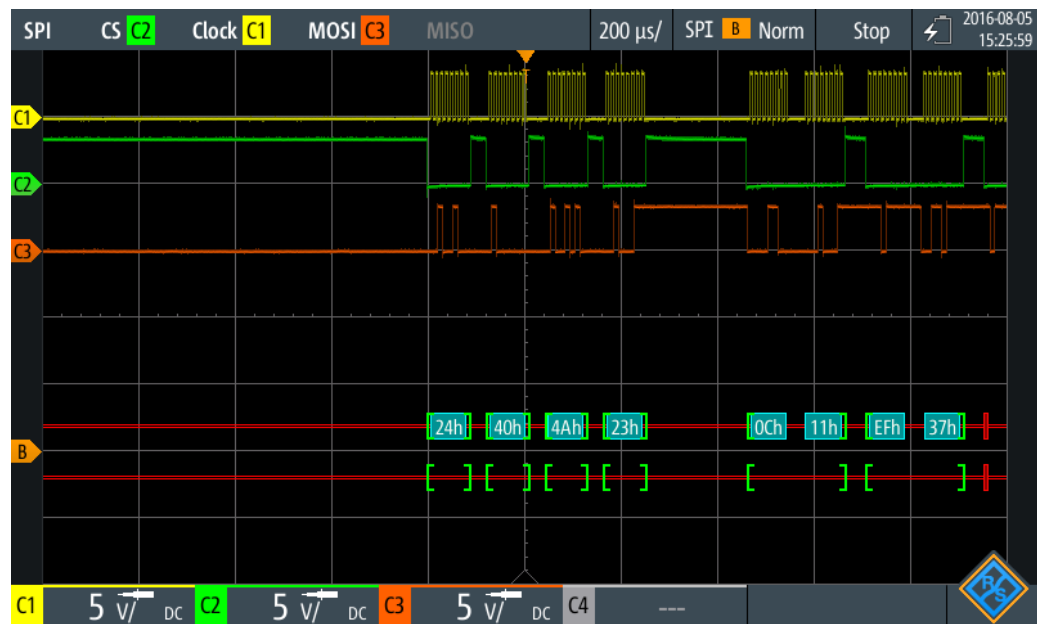

Figure 9-17: Comb display of a decoded SPI signal, triggered on data pattern 40 (hex)

The color-coding of the various protocol sections and errors simplifies the interpretation of the visual display.

Table 9-3: Color codes of decoded SPI signals

Color, display element	Description
Green brackets [...]	Start and end of frame
Cyan comb	Data words
Red	Error, or insufficient frame (end of acquisition before decoding has been completed)

In "Protocol" mode, decoded data is shown in tabular form.

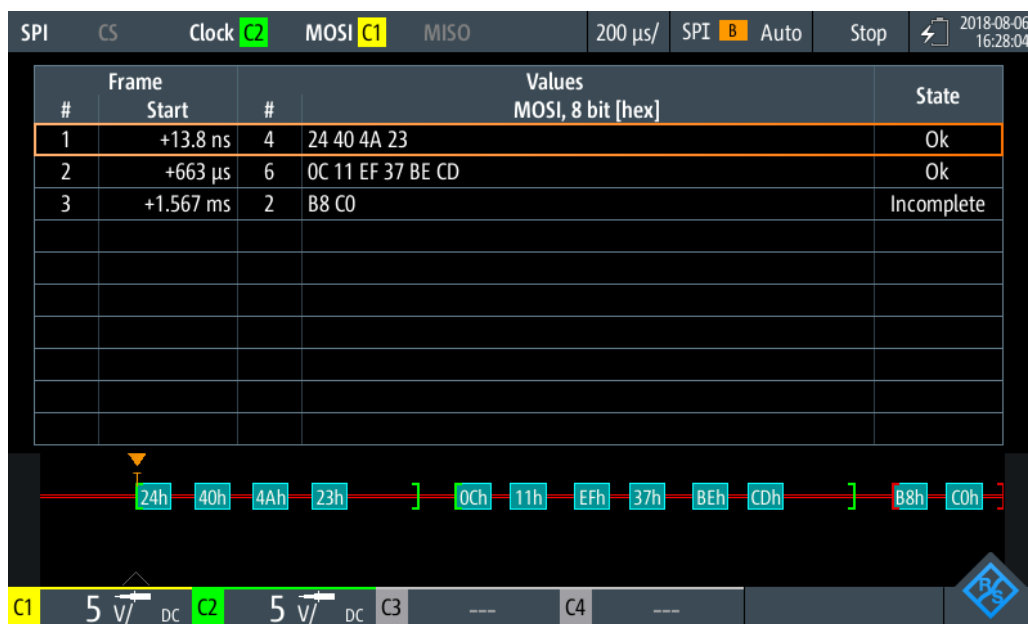

Figure 9-18: Decoded SPI signal in Protocol mode

Table 9-4: Content of the protocol table for decoded SPI signal

Column	Description
#	Frame index
Frame Start	Time of frame start
MOSI <x> bit [format]	Value of the MOSI data word. The data format is selected in the "Bus" menu. The column header indicates the selected word length.
MISO <x> bit [format]	Value of the MISO data word. The data format is selected in the "Bus" menu. The column header indicates the selected word length.
State	Overall state of the frame. "Incomplete" indicates that the frame is not completely contained in the acquisition. Change the time scale, or move the reference point to the left to get a longer acquisition.

Remote commands are described in [Chapter 15.11.3.3, "SPI Decode Results"](#), on page 445.

9.4 UART/RS-232/RS-422/RS-485 (Option R&S RTH-K2)

9.4.1 UART Interface

The Universal Asynchronous Receiver/Transmitter UART converts words of data into serial data, and vice versa. It is the base of many serial protocols like of RS-232 and

RS-422. The UART uses only one line, or two lines for transmitter and receiver. The R&S RTH can analyze one UART line.

Data transfer

The data is transmitted in words, also referred to as symbols or characters. Each word consists of a start bit, several data bits, an optional parity bit, and one or more stop bits. Several words can form a frame, or package. The end of a frame is marked by a pause between two symbols.



Figure 9-19: Bit order in a UART word (symbol)

- The start bit is a logic 0.
- The stop bits and the idle state are always logic 1.

The UART protocol has no clock for synchronization. The receiver synchronizes by means of the start and stop bits, and the bit rate that must be known to the receiver.

Trigger

The R&S RTH can trigger on specified parts of UART serial signals:

- Start bit of a word
- Frame start
- Data pattern
- Parity error
- Stop error
- Break

9.4.2 UART Configuration Settings

Access: "Bus" menu > "Bus Protocol" = "UART" > "Config"

Source	C1	Polarity	Idle High	Threshold	1.399 V
Bit Rate	14.4 kbps	Predefined Bit Rates	14.4 kbps	Technology	User
Data Bits	8 bit	Parity	None	Find Level	
Bit Order	MSB First	Frame Mode	None	Stop Bits	1 bit
				Idle Time	1 ms

Source

Selects the input channel to which the UART line is connected.

If option R&S RTH-B1 is installed, digital channels can also be used as source.

Remote command:

[BUS:UART:SOURce](#) on page 449

Polarity

Defines the logic states of the line. In idle high state, the idle state corresponds to a logic 1, and the start bit to a logic 0. In idle low state, the idle state corresponds to a logic 0, and the start bit to a logic 1. During idle time, no data is transmitted.

Remote command:

[BUS:UART:POLarity](#) on page 449

Threshold, Technology, Find Level

Sets the threshold value for digitization of signals. If the signal value is higher than the threshold, the signal state is high. Otherwise, the signal state is considered low. The interpretation of high and low is defined by the [Polarity](#).

You can select the threshold voltages for various types of integrated circuits in the "Technology" list, or set a user-defined value in "Threshold". You can also let the instrument set the appropriate threshold using "Find Level".

Changing the thresholds in the bus configuration changes also the thresholds of analog channels in the "Vertical" menu, or the thresholds of logic channels in the "Logic" menu.

Remote command:

[BUS:UART:TECHnology](#) on page 450

[BUS:UART:THReshold](#) on page 450

[BUS:SETReflevels](#) on page 432

[CHANnel<m>:THReshold:FINDlevel](#) on page 310

Predefined Bit Rates, Bit Rate

Set the number of transmitted bits per second.

You can select a predefined value in the "Predefined Bit Rates" list, or set a user-defined value in "Bit Rate".

Remote command:

[BUS:UART:STDBitrate](#) on page 450

[BUS:UART:BITRate](#) on page 451

Data Bits

Sets the number of data bits in a word (symbol) in a range from 5 bits to 9 bits.

Remote command:

[BUS:UART:SSIZE](#) on page 451

Parity

Defines the optional parity bit that is used for error detection.

"None" No parity bit is used.

"Odd" The parity bit is set to "1" if the number of data bits set to "1" is even.

"Even" The parity bit is set to "1" if the number of data bits set to "1" is odd.

Remote command:

[BUS:UART:PARity](#) on page 451

Stop Bits

Sets the number of stop bits: 1 or 1.5 or 2 stop bits are possible.

Remote command:

[BUS:UART:SBIT](#) on page 451

Bit Order

Defines if a word starts with MSB (most significant bit) or LSB (least significant bit).

The display of the decoded signal considers this setting, results are displayed in the specified order.

Remote command:

[BUS:UART:ORDer](#) on page 451

Frame Mode

Allows you to decode frames of several words in the data stream, which are defined by a timeout between a stop bit and the next start bit. Enter the minimum timeout between two frames in "Idle Time".

Remote command:

[BUS:UART:FRAMemode](#) on page 452

[BUS:UART:TOUT](#) on page 452

9.4.3 UART Trigger Settings

Access: "Bus" menu > "Bus Protocol" = "UART" > "Trigger"

UART Trigger

Selects the trigger type for UART analysis.

"Start Bit"	Triggers on a start bit. The start bit is the first low bit after a stop bit if polarity is idle high.
"Frame Start"	Triggers on the begin of a data frame. The frame start is configured with <code>BUS:UART:FRAMEmode</code> .
"Data"	Triggers on a serial pattern or data word. You can define the Pattern and Relation .
"Parity Error"	Triggers on a parity error, which indicates a transmission error. This trigger type is only available if a parity is configured for the UART bus.
"Stop Error"	Triggers if the stop bit is a logic 0.
"Break Condition"	Triggers if a start bit is not followed by a stop bit, and the data line remains at logic 0 for longer than a UART word.

Remote command:

`TRIGger:UART:TYPE` on page 452

Pattern

Specifies the data pattern to be found on the specified trigger source, in binary or hex format. Enter the words in MSB first bit order.

See also [Chapter 3.6.12.1, "Pattern Definition"](#), on page 72.

Remote command:

`TRIGger:UART:DATA` on page 453

Relation

Defines how the defined serial data pattern is compared with the acquired signal. The instrument triggers if the acquired data word is equal or unequal the defined pattern.

Remote command:

`TRIGger:UART:DCondition` on page 453

9.4.4 UART Decode Results

This chapter describes the comb display and the decode results table of decoded UART buses. Basic information on decoding and display of decode results is given in [Chapter 9.1.2, "Decode Results"](#), on page 177.

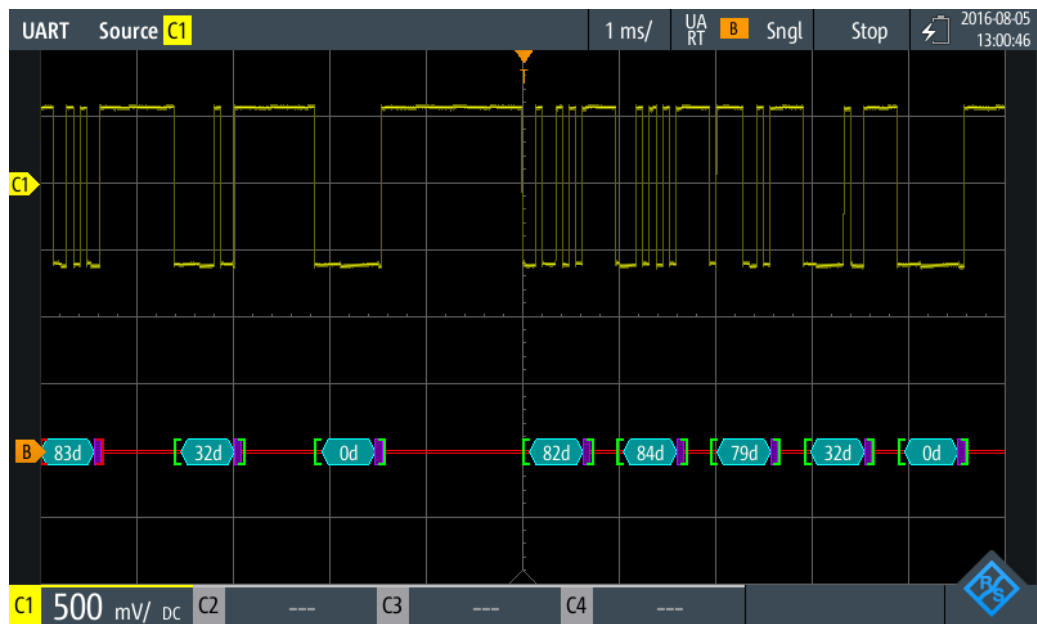

Figure 9-20: Comb display of a decoded UART signal, triggered on start bit

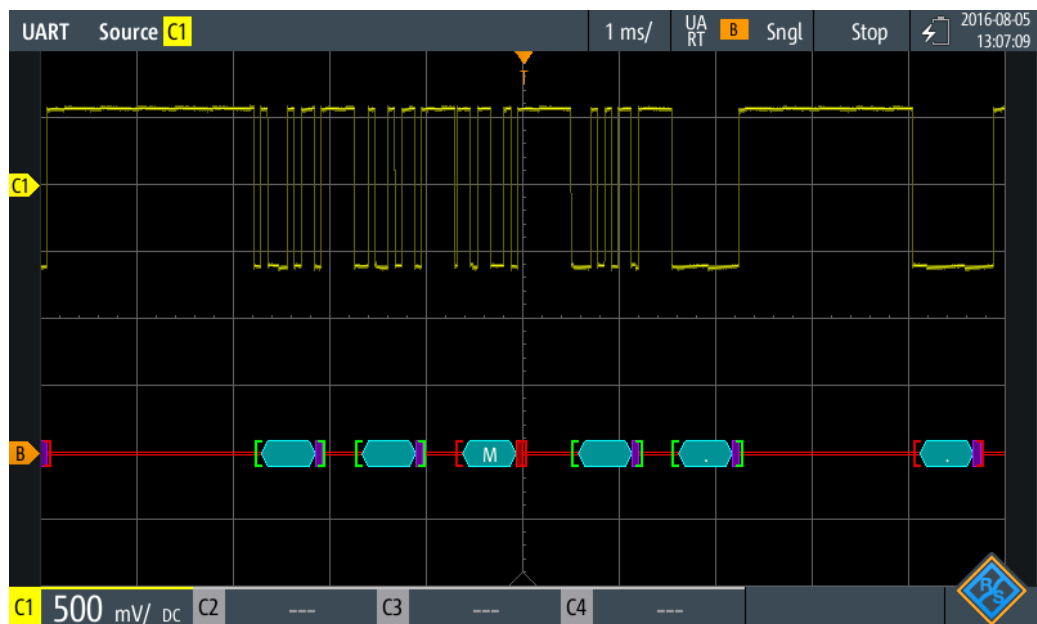

Figure 9-21: Comb display of a decoded UART signal, triggered on parity error

The color-coding of the various protocol sections and errors simplifies the interpretation of the visual display.

Table 9-5: Color codes of decoded UART signals

Color, display element	Description
Green brackets [...]	Start and end of frame
Cyan comb	Data words

Color, display element	Description
Violet comb	Parity bit
Red	Start error, stop error, parity error, or insufficient frame (end of acquisition before decoding has been completed)

In "Protocol" mode, decoded data is shown in tabular form.

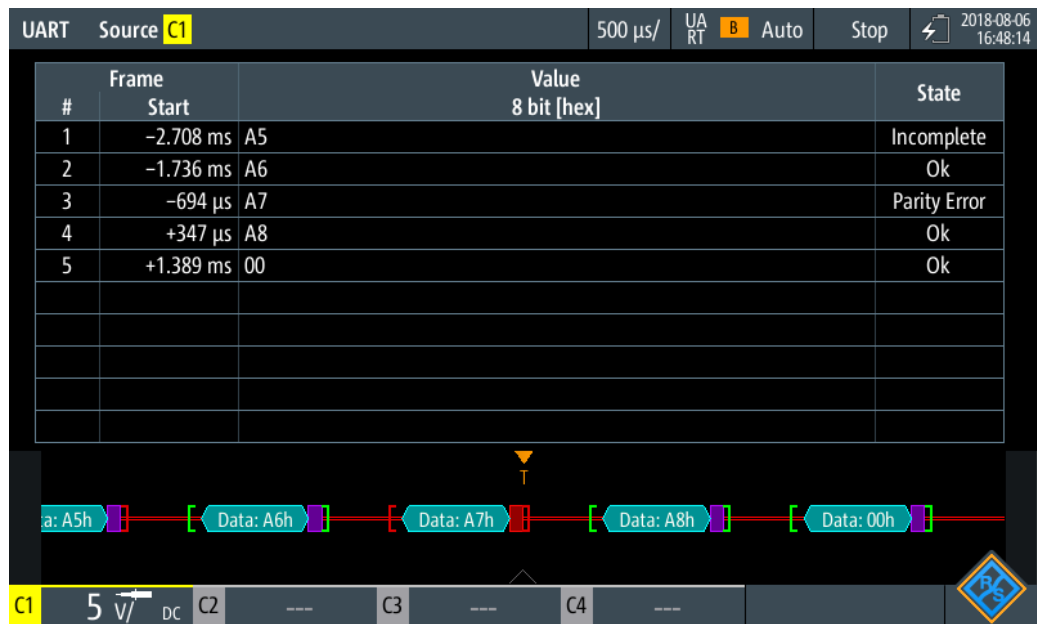

Figure 9-22: Decoded UART signal in Protocol mode

Table 9-6: Content of the protocol table for decoded UART signal

Column	Description
#	Frame index
Frame Start	Time of frame start
Value <x> bit [format]	Value of the data word. The data format is selected in the "Bus" menu. The column header indicates the selected word length.
State	Overall state of the frame. "Incomplete" indicates that the frame is not completely contained in the acquisition. Change the time scale, or move the reference point to the left to get a longer acquisition.

Remote commands are described in [Chapter 15.11.4.3, "UART Decode Results"](#), on page 453.

9.5 CAN and CAN FD (Options R&S RTH-K3, R&S RTH-K9)

CAN is the Controller Area Network, a bus system designed by Bosch for use within automotive network architecture, for example, for brake, power train and engine management. Today, it is also used in many other systems, for example, in industrial machines, aerospace, subsea, merchant marine etc..

More than 20 years after the invention of CAN, communication needs have increased, and CAN has reached its bandwidth limits in some application fields. Therefore, Bosch specified an improved CAN protocol with flexible data rate - CAN FD. It introduces a higher bit rate in the data phase up to 15 Mbit/s and an extended data field from up to 64 bytes.

The R&S RTH provides decoding, triggering and searching CAN and CAN FD signals with following options:

- CAN: option R&S RTH-K3
- CAN FD: option R&S RTH-K9, requires CAN option R&S RTH-K3

9.5.1 The CAN/CAN FD Protocol

This chapter provides an overview of the protocol characteristics, frame types, information transfer and message formats.

The CAN 2.0 specification defines two formats: the base CAN (version 2.0A) with an 11-bit identifier and the extended CAN (version 2.0B) with a 29-bit identifier. Based on these specifications the CAN standard ISO 11898-1 was released, in 1993.

More than 20 years after the invention of CAN, communication needs have increased, and CAN has reached its bandwidth limits in some application fields. Therefore, Bosch specified an improved CAN protocol with flexible data rate - CAN FD. It introduces a higher bit rate in the data phase up to 15 Mbit/s and an extended data field of up to 64 bytes. In 2015, the CAN FD specification has also been integrated in the standard ISO 11898-1.

CAN/CAN FD characteristics

Main characteristics of CAN/CAN FD are:

- Differential signaling.
- Transmission over two wires, high and low.
- Multi-master, which means that any node can begin to transmit a message, when a bus is free.
- Bitwise arbitration.

Arbitration

Information transfer is done by carrier sense multiple access/bitwise arbitration (CSMA/BA). Each node waits for a certain inactive period before it tries to send a message. Collisions are resolved through a bitwise arbitration that is non-destructive.

Each message has a priority which is implied in the identifier value - the lower the value, the higher the priority. A dominant bit from the message with highest priority overwrites the recessive bits on the bus. If a node detects that the bus is already receiving a message that has a higher priority, it stops the transmission and waits for the current transmission to end before retransmitting.

Frame types

The CAN/CAN FD protocol defines the following types of frames:

- Data: used for information transmission.
- Remote: used for information request. The destination node sends this frame to the source to request data. This type of frame is only used by CAN.
- Error: indicates that a bus node has detected transmission error.
- Overload: used from a bus node to request a transmission delay.

CAN data message format

The CAN protocol defines two formats for the data frame: the base frame format and the extended frame format. The data frames are built as follows:

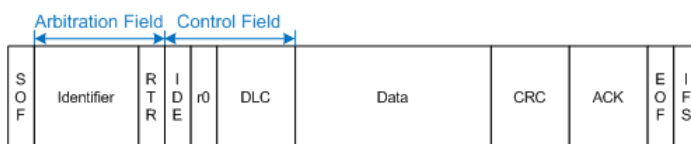

Figure 9-23: CAN basic frame

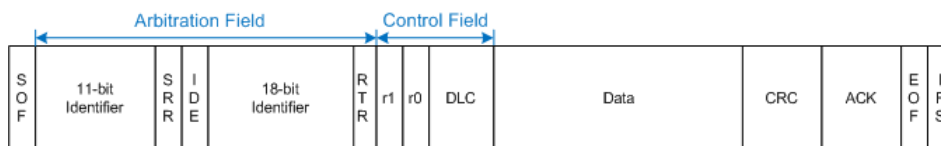

Figure 9-24: CAN extended frame

The following fields, compose the base/extended frame format:

- **SOF**: start of frame. 1 dominant bit that marks the beginning of the message.
- **Identifier**: 11/18-bit identifier. Contains information about the priority of the message. CAN base frames have an 11-bit identifier while CAN extended frames have a total of 29 bits identifier.
- **RTR**: remote transmission request bit. Differentiates between base and extended frames. It is dominant for base data frames and recessive for extended data frames.
- **SRR**: substitute remote request. Only present in extended CAN frames at the position of the RTR bit in base frames.
- **IDE**: identifier extension bit. It helps to distinguish between a base and extended data frame. It is dominant for data frames and recessive for remote frames
- **r0/r1**: reserved bits for possible future use.
- **DLC**: data length code. Defines how many bytes of data follow.

- **Data:** up to 8 bytes of data can be transmitted for CAN.
- **CRC:** cyclic redundancy check. Checks the integrity of the frame contents.
- **ACK:** acknowledgement. This is a recessive bit that is overwritten by the node, if the message was transmitted correctly.
- **EOF:** end-of-frame: marks the end of the message.
- **IFS:** interframe space. Separates a data or remote frame from the preceding frames.

CAN FD data message format

There are many common features between the CAN and CAN FD protocol. The main differences are:

- CAN FD defines a data length of up to 64 bytes.
- CAN FD defines two bit nodes, one for arbitration phase and one for data phase.
- The transmission of control field from BRS bit onwards, data field and CRC field at higher data rate.
- The CRC size and computation differ from CAN.

The CAN FD protocol also defines two formats for the data frame: the base frame format and the extended frame format. The data frames of the CAN FD are built as follows:

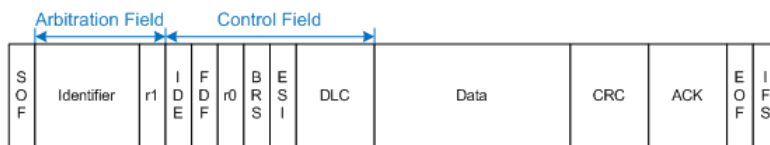

Figure 9-25: CAN FD basic frame

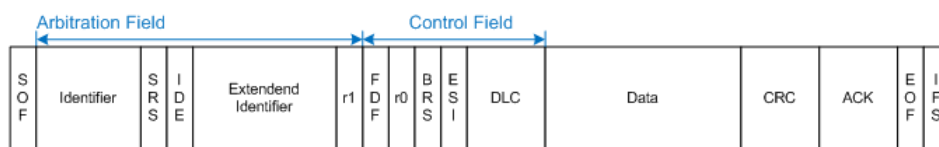

Figure 9-26: CAN FD extended frame

There are many common fields that are used both for the CAN and CAN FD frames. For a description of those fields, see "CAN data message format" on page 207.

The following fields are present also for the CAN FD frames:

- **Data:** up to 64 bytes of data can be transmitted for CAN FD.
- **FDF:** FD format. Distinguishes between the CAN and CAN FD frames.
- **BRS:** bit rate switch. Determines if the bit rate is turned on for the CAN FD frame.
- **ESI:** error state indicator. It is dominant for error active nodes and recessive for error passive nodes.

9.5.2 CAN Configuration Settings

Access: "Bus" menu > "Bus Protocol" = "CAN" > "Config"

Source	C1	Polarity	CAN_L	Threshold	2.5 V
CAN Standard	CAN	Technology	CMOS	Find Level	
Bit Rate	50 kbps	Predefined Bit Rates	50 kbps	Sample Point	50 %

Source	C1	Polarity	CAN_L	Threshold	1.4 V
CAN Standard	CAN FD	CAN FD Standard	ISO	Technology	User
Arbitration Bit Rate	50 kbps	Predefined Bit Rates	50 kbps	Find Level	
Data Bit Rate	50 kbps	Predefined Bit Rates	50 kbps	Sample Point	66 %

Source

Sets the input channel of the CAN line. All active analog channels can be used. If option R&S RTH-B1 is installed, digital channels can also be used as source.

Remote command:

[BUS:CAN:DATA:SOURce](#) on page 455

Polarity

Selects whether the chip select signal is high active (high = 1) or low active (low = 1).

Remote command:

[BUS:CAN:TYPE](#) on page 456

Threshold, Technology, Find Level

Sets the threshold value for digitization of signals. If the signal value is higher than the threshold, the signal state is high. Otherwise, the signal state is considered low.

You can select the threshold voltage on the source CAN for various types of integrated circuits in the "Technology" list, or set a user-defined value in "Threshold". You can also let the instrument set the appropriate threshold using "Find Level".

Changing the thresholds in the bus configuration changes also the thresholds of analog channels in the "Vertical" menu, or the thresholds of logic channels in the "Logic" menu.

Remote command:

[BUS:CAN:TECHnology](#) on page 456

[BUS:CAN:DATA:THReshold](#) on page 457

[BUS:SETReflevels](#) on page 432

[CHANnel<m>:THReshold:FINDlevel](#) on page 310

CAN Standard

Selects the CAN protocol.

For decoding CAN buses, option R&S RTH-K3 is required and for CAN FD option R&S RTH-K9.

Remote command:

[BUS:CAN:FDATA:ENABLE](#) on page 458

CAN FD Standard

The setting is available in CAN FD option R&S RTH-K9.

Selects the standard of the tested CAN FD signal.

"Non-ISO" Signals are decoded according to the Bosch CAN FD protocol.

"ISO" Signals are decoded according to the ISO CAN FD protocol. This protocol has an additional stuff count field before the CRC sequence.

Remote command:

[BUS:CAN:FDATA:PStandard](#) on page 458

Bit Rate, Predefined Bit Rates

Sets the number of transmitted bits per second. The maximum bit rate is 1 Mbit/s.

To select a bit rate from the list of predefined values, tap the "Predefined Bit Rates" field, then select the value.

To set a user-defined value, double-tap the "Bit Rate" field, then enter the value and unit using the displayed keypad. The "Predefined Bit Rates" setting is automatically set to "User".

Remote command:

[BUS:CAN:BITRate](#) on page 456

Arbitration Bit Rate, Predefined Bit Rates

The setting is available in CAN FD option R&S RTH-K9.

Sets the bit rate of the arbitration phase. The maximum bit rate is 1 Mbit/s.

To select a bit rate from the list of predefined values, tap the "Predefined Bit Rates" field, then select the value.

To set a user-defined value, double-tap the "Arbitration Bit Rate" field, then enter the value and unit using the displayed keypad. The "Predefined Bit Rates" setting is automatically set to "User".

Remote command:

[BUS:CAN:FDATA:ABITrate](#) on page 457

Data Bit Rate, Predefined Bit Rates

The setting is available in CAN FD option R&S RTH-K9.

Sets the bit rate of the data phase. The data rate can be equal or higher than the arbitration rate; and it is uniform and fixed for a given CAN FD bus.

To select a data rate from the list of predefined values, tap on "Predefined Bit Rates" beside the field. To enter a specific value, open the keypad. The list of predefined values is also available in the keypad.

To set a user-defined value, double-tap the "Data Bit Rate" field, then enter the value and unit using the displayed keypad. The "Predefined Bit Rates" setting is automatically set to "User".

Remote command:

[BUS:CAN:FDATA:DBITrate](#) on page 458

Sample Point

The CAN bus interface uses an asynchronous transmission scheme. The standard specifies a set of rules to resynchronize the local clock of a CAN node to the message.

The sample point divides the nominal bit period into two distinct time segments. The length of the time segments is defined in time quanta according to network and node conditions during CAN development.

For CAN FD signals, you can define the sample point separately for the arbitration phase and data phase.

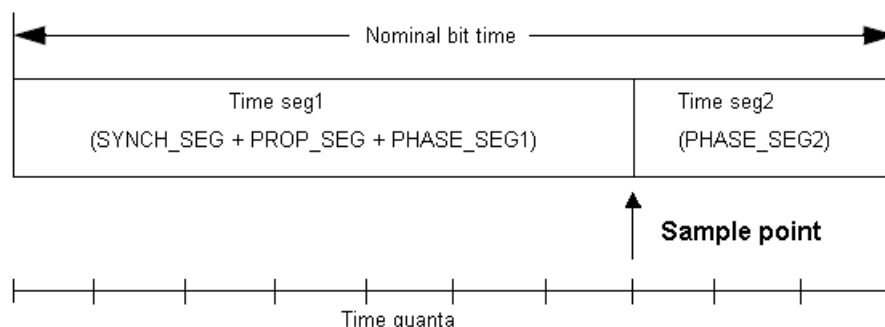

Remote command:

[BUS:CAN:SAMPlepoint](#) on page 457

[BUS:CAN:FDATA:ASAMPlepoint](#) on page 457

[BUS:CAN:FDATA:DSAMPlepoint](#) on page 458

9.5.3 CAN Trigger Settings

Access: [Setup] ([Trigger]) > "Trigger type" = "Bus"

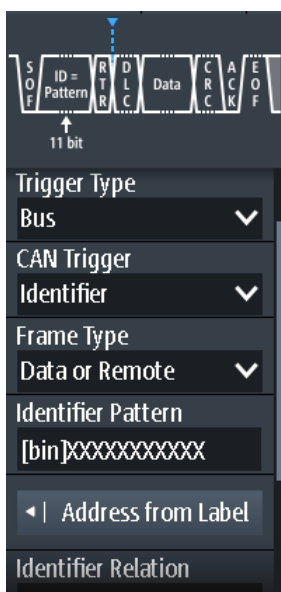

CAN Trigger..... 212

Frame type..... 213

ID type..... 213

Identifier Pattern..... 213

Identifier Relation..... 214

FDF Bit..... 214

BRS Bit..... 214

ESI Bit..... 214

Data Pattern..... 214

Data Relation..... 214

Byte Offset..... 215

Address from Label..... 215

Error conditions: CRC, Bit stuffing, Form, Ack, SC..... 215

CAN Trigger

Depending on the selected CAN trigger type, different additional parameters are available.

- "Start of Frame" Triggers on the stop bit of the sync field.
- "End of frame" Triggers after a wakeup frame.
- "Frame type" Triggers on a specified frame type (data, remote, error, or overload). For data and remote frames, also the identifier format is considered.
- "Identifier" Sets the trigger to a specific identifier or an identifier range. Only the 6-bit identifier without parity bits is considered, not the protected identifier.
- "Identifier + Data" Sets the trigger to a combination of identifier and data condition. The instrument triggers at the end of the last byte of the specified data pattern.

"Error condition"

Identifies various errors in the frame. You can select one or more error types as the trigger condition.

Remote command:

[TRIGger:CAN:TYPE](#) on page 462

Frame type

CAN has several frame types which can be used as trigger condition.

For data and remote frames, the identifier format has to be set with [ID type](#).

"Error"	When a node recognizes an error, it cancels transmission by sending an error frame. The instrument triggers seven bit-periods after the end of the error flag that is marked by a dominant-recessive edge. The ID type is irrelevant for error frames.
"Overload"	When a node needs a delay between data and/or remote frames, it sends an overload frame. The instrument triggers seven bit-periods after the end of the overload flag that is marked by a dominant-recessive edge. The ID type is irrelevant for overload frames.
"Data"	The data frame is the only frame for actual data transmission.
"Remote"	Remote frames are only available in the CAN protocol. The remote frame initiates the transmission of data by another node. The frame format is the same as of data frames but without the data field.
"Data or Remote"	Data frames or remote frames initiate the transmission of data by another node. The frame format is the same as of data frames.

Remote command:

[TRIGger:CAN:FTYPE](#) on page 460

ID type

Selects the length of the identifier:

"11 bit"	Identifier length of the CAN base frame format. The instrument triggers on the sample point of the IDE bit (identifier extension flag).
"29 bit"	Identifier length of the CAN extended frame format. The instrument triggers on the sample point of the RTR bit.
"Any"	The ID type and ID pattern are not relevant for the trigger condition. If the trigger type is "Identifier", the instrument triggers on any identifier in the specified frame type. If the trigger type is "Identifier + Data", set the "ID type" to "Any" if you want to trigger only on data.

Remote command:

[TRIGger:CAN:ITYPe](#) on page 461

Identifier Pattern

Specifies the identifier pattern to be found, in binary or hex format. Enter the pattern in MSB first bit order.

See also [Chapter 3.6.12.1, "Pattern Definition"](#), on page 72.

Remote command:

`TRIGger:CAN:IDENTifier` on page 461

Identifier Relation

Defines how the specified identifier pattern is compared with the acquired signal. The instrument triggers if the acquired address is equal or unequal the defined pattern.

Remote command:

`TRIGger:CAN:ICONdition` on page 461

FDf Bit

The bit determines whether a frame is CAN or CAN-FD. It corresponds to the EDL bit (extended data length), which only exists in CAN FD format. If you do not know if the signal is CAN or CAN FD, you can use this bit to identify the format.

Remote command:

`TRIGger:CAN:FDATa:FDf` on page 463

BRS Bit

The setting is available in CAN FD option R&S RTH-K9.

Sets the the bit rate switch bit.

Value 1 means that the bit rate switches from the "Arbitration rate" to the faster "Data rate".

Remote command:

`TRIGger:CAN:FDATa:BRS` on page 462

ESI Bit

The setting is available in CAN FD option R&S RTH-K9.

Sets the error state indicator bit. If set to "Dominant", the bit indicates an error active state.

Remote command:

`TRIGger:CAN:FDATa:ESI` on page 463

Data Pattern

Specifies the data pattern to be found, in binary or hex format. Enter the pattern in MSB first bit order.

See also [Chapter 3.6.12.1, "Pattern Definition"](#), on page 72.

Remote command:

`TRIGger:CAN:DATA` on page 460

Data Relation

Defines how the specified data pattern is compared with the acquired signal. The instrument triggers if the acquired address is equal or unequal the defined pattern.

Remote command:

`TRIGger:CAN:DCONdition` on page 460

Byte Offset

The setting is available in CAN FD option R&S RTH-K9.

Sets the byte offset, that defines the start position of the data for the data pattern comparison.

Remote command:

[TRIGGER:CAN:FDATA:DPOSITION](#) on page 463

Address from Label

If a label list with node names was loaded and applied in the bus configuration, you can select the node name from the list instead of entering the numeric identifier.

The instrument triggers on the identifier of the selected node.

Error conditions: CRC, Bit stuffing, Form, Ack, SC

If a CAN detects a bit stuffing error, form error, or Ack error, it transmits an error flag at the next bit. The R&S RTH detects errors in the message and triggers on these errors even if no CAN node sends an error flag.

- **CRC error**
CAN uses the cyclic redundancy check (CRC), which is a complex checksum calculation method. The transmitter calculates the CRC and sends the result in the CRC sequence. The receiver calculates the CRC in the same way. A CRC error occurs when the calculated result differs from the received value in the CRC sequence.
- **Bit stuffing error**
The frame segments Start Of Frame, Arbitration Field, Control Field, Data Field and CRC Sequence are coded by the bit stuffing method. The transmitter automatically inserts a complementary bit into the bit stream when it detects five consecutive bits of identical value in the bit stream to be transmitted. A stuff error occurs when the 6th consecutive equal bit level in the mentioned fields is detected.
- **Form error**
A form error occurs when a fixed-form bit field contains one or more illegal bits.
- **Ack error**
An acknowledgement error occurs when the transmitter does not receive an acknowledgment - a dominant bit during the Ack slot.
- **SC error**
A stuff count (SC) error occurs if the received stuff count value does not match the value calculated from the own stuff bit count.
Only relevant for CAN FD signals in ISO standard.

Remote command:

[TRIGGER:CAN:ACKerror](#) on page 459

[TRIGGER:CAN:BITSterror](#) on page 459

[TRIGGER:CAN:CRCErrror](#) on page 460

[TRIGGER:CAN:FORMerror](#) on page 460

[TRIGGER:CAN:FDATA:SCERror](#) on page 463

9.5.4 CAN Label List

Label list files (symbolic data files) for CAN protocols are available in PTT and CSV file formats, similar to other serial protocols. In addition, the R&S RTH can read and apply DBC files to the decoded signal and use them for triggering.

For general information on label lists, see [Chapter 9.1.3, "Label Lists"](#), on page 180.

9.5.4.1 PTT and CSV Files for CAN

Label list files are protocol-specific. A PTT label file for CAN protocols contains three values for each identifier:

- Identifier type, 11-bit or 29-bit long
- Identifier value
- Label, symbolic name of the identifier, specifying its function in the bus network.

Example: CAN PTT file

```
# -----
@FILE_VERSION = 1.00
@PROTOCOL_NAME = can
# -----
# Labels for CAN protocol
# Column order: Identifier type, Identifier value, Label
# -----
11,064h,Diag_Response
11,1E5h,EngineData
11,0A2h,Ignition_Info
11,1BCh,TP_Console
11,333h,ABSdata
11,313h,Door_Left
11,314h,Door_Right
29,01A54321h,Throttle
29,13A00FA2h,LightState
29,0630ABCDh,Engine_Status
29,03B1C002h,Airbag_Status
29,01234ABCh,NM_Gateway
# -----
```

9.5.4.2 DBC Files for CAN

Industry-standard DBC files contain more information than PTT and CSV files and translate the abstract decode results to human language. For each frame, the frame ID and the symbolic name of the ID are given; the frames are also called messages in CAN. The data of a CAN message can consist of several "signals". The DBC file provides the label, unit, start bit, length and other indicators for each signal. For state-encoded signals, the meaning of the states is given.

In the demo example, the message "EngineData" has the decimal ID 2,166,573,756 and consists of 8 data bytes. These 8 bytes are defined as 6 signals. The first one,

"PetrolLevel", starts at bit #24, has a length of 8 bit, and the unit is liter. The signal "IdleRunning" is state-encoded. It has only one bit. The binary value 0 means "Running", and the binary value 1 means "Idle".

Example: CAN DBC file section

```
BO_ 2166573756 EngineData: 8 Engine
SG_ PetrolLevel : 24|8@1+ (1,0) [0|255] "l" ...
SG_ EngPower : 48|16@1+ (0.01,0) [0|350] "kW" ...
SG_ EngForce : 32|10@1+ (1,0) [0|1000] "N" ...
SG_ IdleRunning : 23|1@1+ (1,0) [0|1] "" ...
SG_ EngTemp : 16|7@1+ (2,-50) [-50|150] "degC" ....
SG_ EngSpeed : 0|13@1+ (1,0) [0|8000] "rpm" ...
....
VAL_ 2166573756 IdleRunning 0 "Running" 1 "Idle" ;
```

If a DBC file is loaded, the bus menu provides an additional entry: [Display Labels](#).

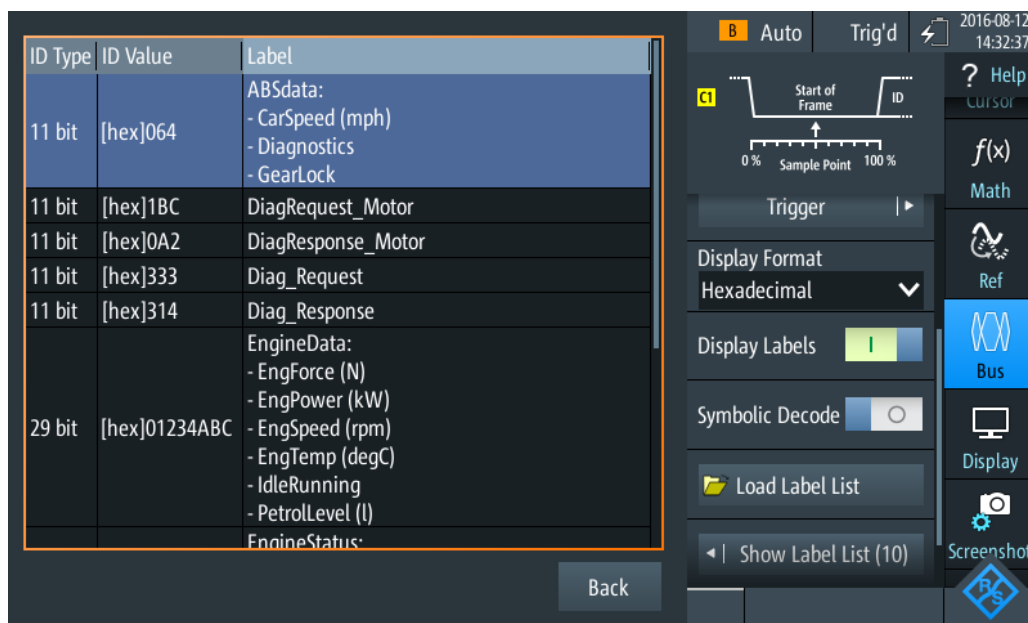

Figure 9-27: Display of an CAN DBC file

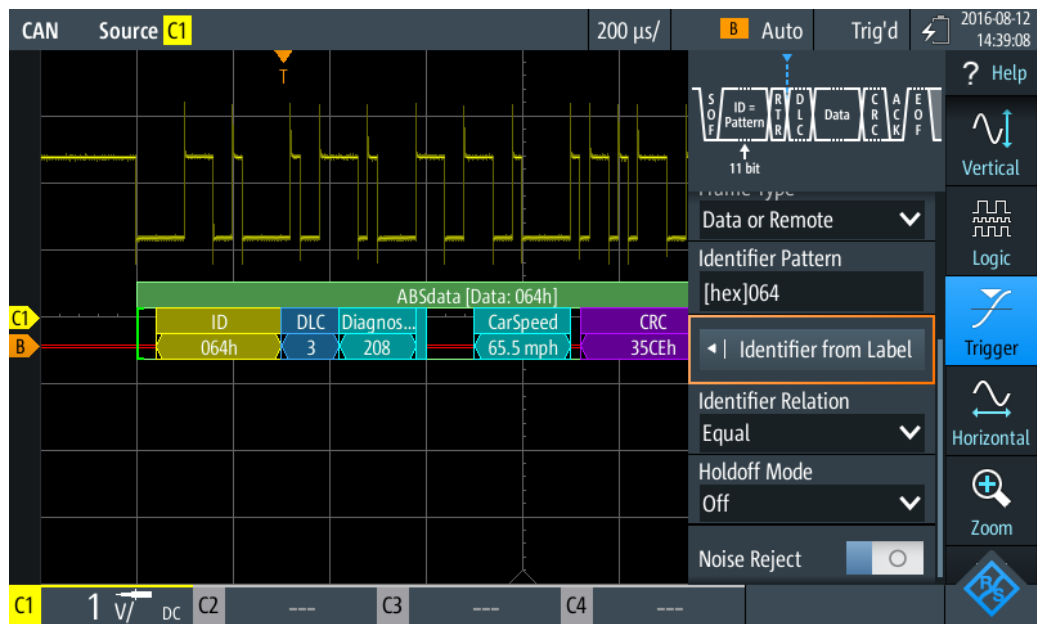

Figure 9-28: Trigger on message "ABSdata", identifier value 064 (hex)

9.5.5 CAN Decode Results

This chapter describes the comb display and the decode results table of decoded CAN buses. Basic information on decoding and display of decode results is given in [Chapter 9.1.2, "Decode Results"](#), on page 177.

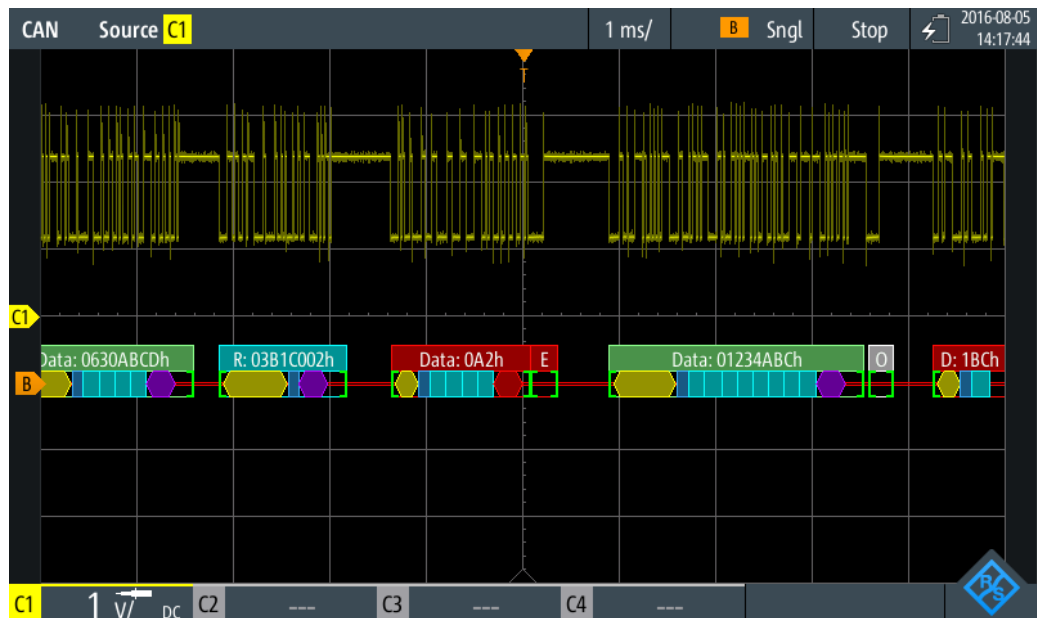

Figure 9-29: Comb display of a decoded CAN signal, triggered on CRC error

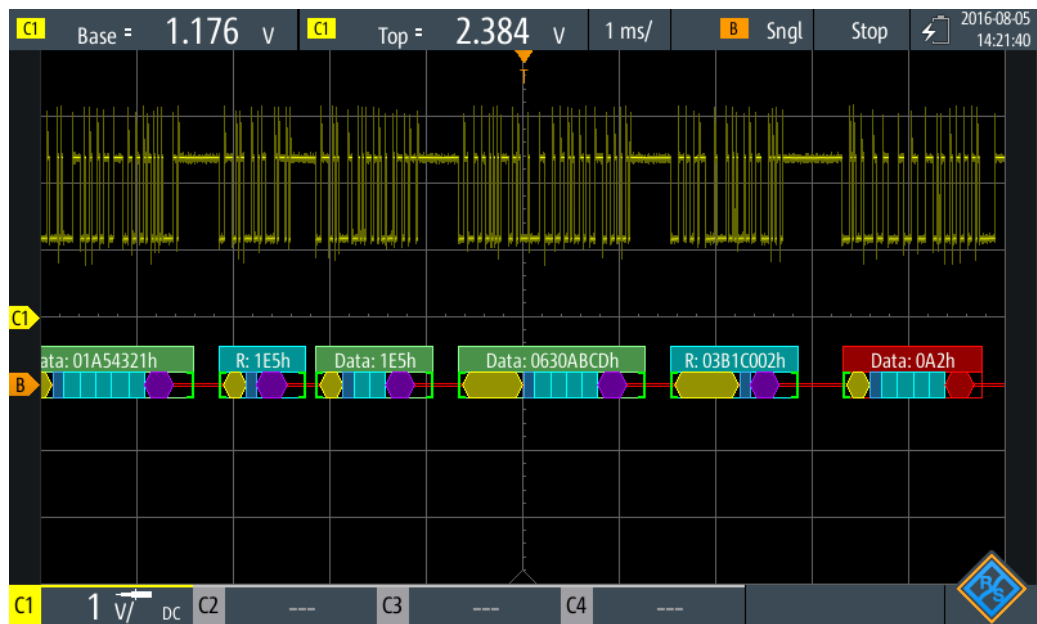

Figure 9-30: Comb display of a decoded CAN signal, triggered on address 0630ABCD (hex)

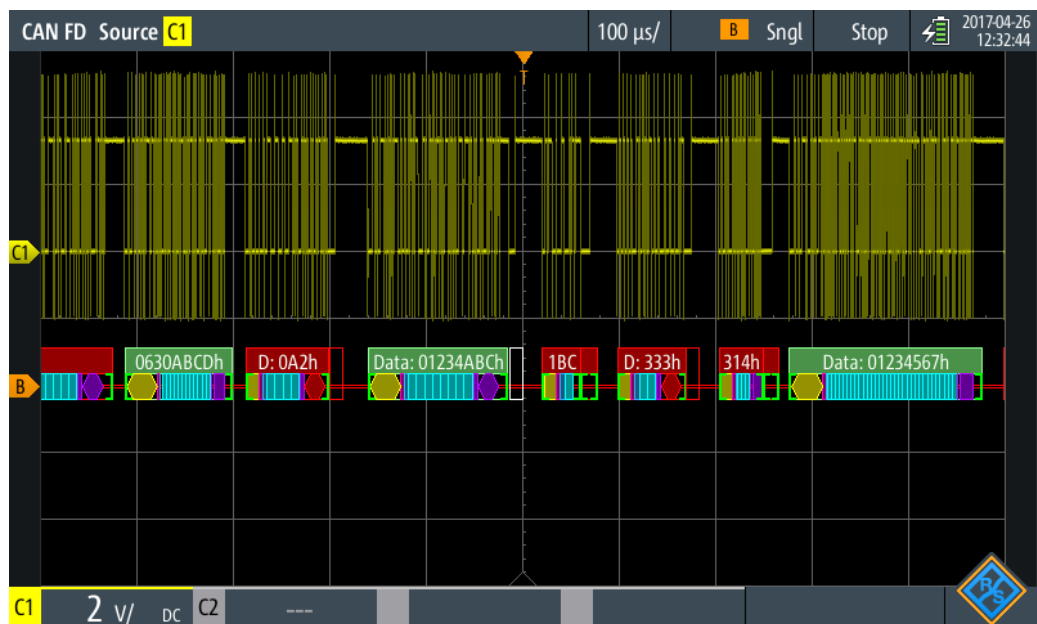

Figure 9-31: Comb display of a decoded CAN FD signal, triggered on overload frame

The color-coding of the various protocol sections and errors simplifies the interpretation of the visual display.

Table 9-7: Color codes of decoded CAN signals

Color, display element	Description
Green brackets [...]	Start and end of frame
Green frame header	Data frame. Text indicates the frame type and frame ID (hex).

Color, display element	Description
Cyan frame header	Remote frame. Text indicates the frame type and frame ID (hex).
White frame header	Overload frame. Text indicates the frame type.
Yellow comb	ID (standard 11 bit and extended 29 bit)
Cyan comb	Data bytes
Blue comb	Data length code (DLC)
Violet	CRC
Red	Error frame, start/stop error, CRC error, stuff bit error, form error, ACK error, insufficient frame (end of acquisition before decoding has been completed)

In "Protocol" mode, decoded data is shown in tabular form.

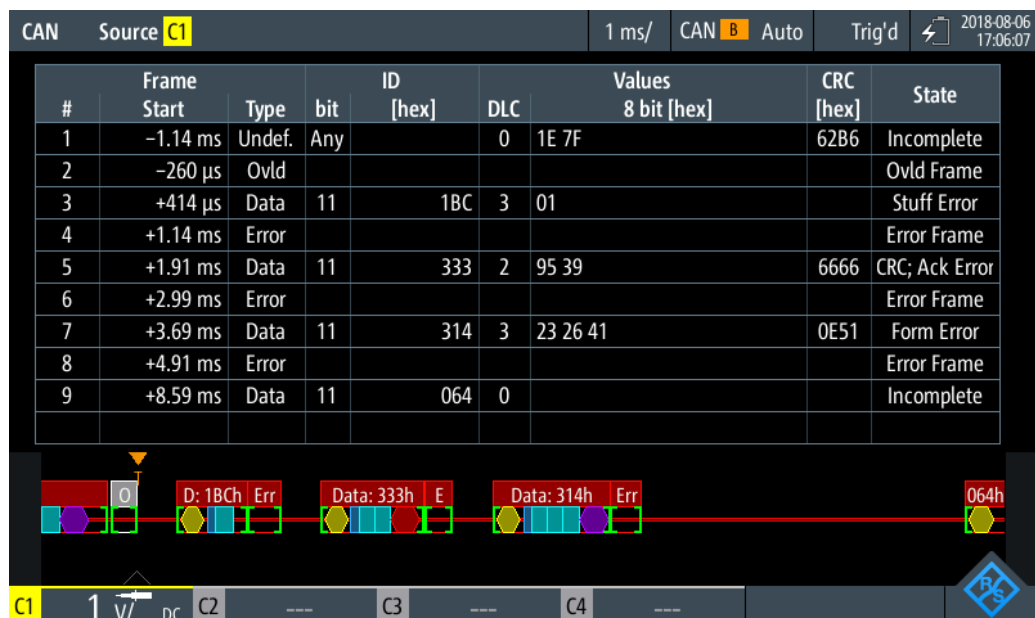

Figure 9-32: Decoded CAN signal in Protocol mode

Table 9-8: Content of the protocol table for decoded CAN signal

Column	Description
#	Frame index
Frame Start	Time of frame start
Frame Type	Data, remote, overload or error frame
ID bit	ID type, 11 bit standard format or 29 bit extended format
ID [hex]	Identifier value, hexadecimal value
DLC	Data length code, coded number of data bytes
Values 8 bit [format]	Values of data frames. The data format is selected in the "Bus" menu.

Column	Description
CRC	CRC value
State	Overall state of the frame. "Incomplete" indicates that the frame is not completely contained in the acquisition. Change the time scale, or move the reference point to the left to get a longer acquisition.

Remote control commands are described in [Chapter 15.11.5.3, "CAN Decode Results"](#), on page 463.

9.6 LIN (Option R&S RTH-K3)

The Local Interconnect Network (LIN) is a simple, low-cost bus system used within automotive network architectures. LIN is usually a subnetwork of a CAN bus. The primary purpose of LIN is to integrate uncritical sensors and actuators with low bandwidth requirements. Common applications in a motor vehicle are the control of doors, windows, wing mirrors, and wipers.

9.6.1 The LIN Protocol

This chapter provides an overview of protocol characteristics, frame format, identifiers and trigger possibilities. For detailed information, order the LIN specification on <http://www.lin-subbus.org/> (free of charge).

LIN characteristics

Main characteristics of LIN are:

- Single-wire serial communications protocol, based on the UART byte-word interface
- Single master, multiple slaves - usually up to 12 nodes
- Master-controlled communication: master coordinates communication with the LIN schedule and sends identifier to the slaves
- Synchronization mechanism for clock recovery by slave nodes without crystal or ceramics resonator

The R&S RTH supports several versions of the LIN standard: v1.3, v2.0, v2.1 and the American SAE J2602.

Data transfer

Basic communication concept of LIN:

- Communication in an active LIN network is always initiated by the master.
- Master sends a message header including the synchronization break, the synchronization byte, and the message identifier.

- The identified node sends the message response: one to eight data bytes and one checksum byte.
- Header and response form the message frame.

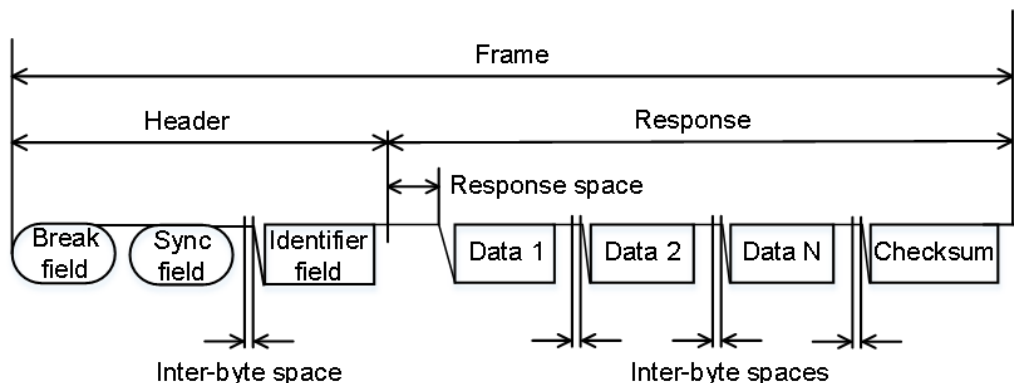

Figure 9-33: LIN frame with header and response

The data is transmitted in bytes using the UART byte-word interface without the parity bit. Each byte consists of a start bit, 8 bits and a stop bit.

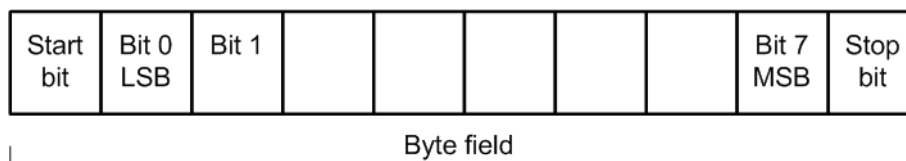

Figure 9-34: Structure of a byte field

Data bytes are transmitted LSB first.

The identifier byte consists of 6 bits for the frame identifier and two parity bits. This combination is known as protected identifier.

Trigger

The R&S RTH can trigger on various parts of LIN frames. The data line must be connected to an input channel, triggering on math and reference waveforms is not possible.

You can trigger on:

- Frame start (synchronization field)
- Specific slave identifier or identifier range
- Data pattern in the message
- Wake up signal
- Checksum error (error in data), parity error (error in identifier)

9.6.2 LIN Configuration Settings

Access: [Protocol] > "Bus type" = "LIN" > "Configuration"

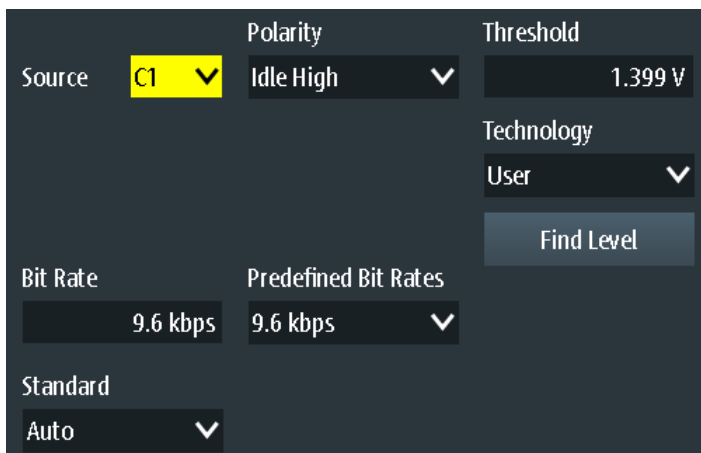

Source.....223
 Polarity.....223
 Standard.....223
 Bit rate, Predefined Bit Rates.....223
 Threshold, Technology, Find Level.....224

Source

Sets the source of the data line. All active analog channels can be used. If option R&S RTH-B1 is installed, digital channels can also be used as source.

Remote command:
[BUS:LIN:DATA:SOURce](#) on page 470

Polarity

Defines the idle state of the bus. The idle state is the recessive state and corresponds to a logical 1.

- "Idle Low" The bus is idle (state = 1) when the signal is low
- "Idle High" The bus is idle (state = 1) when the signal is high

Remote command:
[BUS:LIN:POLarity](#) on page 471

Standard

Selects the version of the LIN standard that is used in the DUT. The setting mainly defines the checksum version used during decoding.

The most common version is v2.x. For mixed networks, or if the standard is unknown, set the LIN standard to "Auto".

Remote command:
[BUS:LIN:STANdard](#) on page 471

Bit rate, Predefined Bit Rates

Sets the number of transmitted bits per second. The maximum bit rate is 20 kbit/s. To select a bit rate from the list of predefined values, tap the "Predefined Bit Rates" field, then select the value.

To set a user-defined value, double-tap the "Bit Rate" field, then enter the value and unit using the displayed keypad. The "Predefined Bit Rates" setting is automatically set to "User Bit Rate".

Remote command:

`BUS:LIN:BITRate` on page 471

Threshold, Technology, Find Level

Sets the threshold value for digitization of signals. If the signal value is higher than the threshold, the signal state is high. Otherwise, the signal state is considered low.

You can select the threshold voltages for various technologies in the "Technology" list, or set a user-defined value in "Threshold". You can also let the instrument set the appropriate threshold using "Find Level".

Changing the thresholds in the bus configuration changes also the thresholds of analog channels in the "Vertical" menu, or the thresholds of logic channels in the "Logic" menu.

Remote command:

`BUS:LIN:TECHnology` on page 472

`BUS:LIN:DATA:THReshold` on page 471

`BUS:SETRefllevels` on page 432

`CHANnel<m>:THReshold:FINDlevel` on page 310

9.6.3 LIN Trigger Settings

Access: [Setup] ([Trigger]) > "Trigger type" = "Bus"

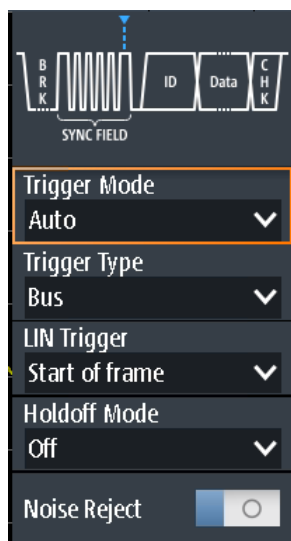

[LIN Trigger](#)..... 225

[Checksum Error](#)..... 225

[Parity Error](#)..... 225

[Sync Error](#)..... 225

[Identifier Pattern](#)..... 225

[Identifier Relation](#)..... 226

Identifier from Label.....	226
Data Pattern.....	226
Data Relation.....	226

LIN Trigger

Depending on the selected LIN trigger type, different additional parameters are available.

"Start of Frame"

Triggers on the stop bit of the sync field.

"Wakeup frame"

Triggers after a wakeup frame.

"Error condition"

Identifies various errors in the frame. You can select one or more error types as the trigger condition.

"Identifier"

Sets the trigger to a specific identifier or an identifier range. Only the 6-bit identifier without parity bits is considered, not the protected identifier.

"Identifier + Data"

Sets the trigger to a combination of identifier and data condition. The instrument triggers at the end of the last byte of the specified data pattern.

Remote command:

[TRIGger:LIN:TYPE](#) on page 474

Checksum Error

Triggers on a checksum error. The checksum verifies the correct data transmission. It is the last byte of the frame response. The checksum includes not only the data but also the protected identifier (PID).

Remote command:

[TRIGger:LIN:CHKSError](#) on page 472

Parity Error

Triggers on a parity error. Parity bits are the bits 6 and 7 of the identifier. They verify the correct transmission of the identifier.

Remote command:

[TRIGger:LIN:IPERror](#) on page 474

Sync Error

Triggers if synchronization caused an error.

Remote command:

[TRIGger:LIN:SYERror](#) on page 474

Identifier Pattern

Specifies the identifier pattern to be found, in binary or hex format. Enter the pattern in MSB first bit order.

See also [Chapter 3.6.12.1, "Pattern Definition"](#), on page 72.

Remote command:

`TRIGger:LIN:IDENTifier` on page 473

Identifier Relation

Defines how the specified identifier pattern is compared with the acquired signal. The instrument triggers if the acquired address is equal or unequal the defined pattern.

Remote command:

`TRIGger:LIN:ICONdition` on page 473

Identifier from Label

If a label list with node names was loaded and applied in the bus configuration, you can select the node name from the list instead of entering the numeric identifier.

The instrument triggers on the identifier of the selected node.

Data Pattern

Specifies the data pattern to be found, in binary or hex format. Enter the pattern in MSB first bit order.

See also [Chapter 3.6.12.1, "Pattern Definition"](#), on page 72.

Remote command:

`TRIGger:LIN:DATA` on page 473

Data Relation

Defines how the specified data pattern is compared with the acquired signal. The instrument triggers if the acquired address is equal or unequal the defined pattern.

Remote command:

`TRIGger:LIN:DCONdition` on page 473

9.6.4 LIN Label List

Label lists are protocol-specific. Label lists for LIN are available in CSV and PTT format.

A LIN label file contains two values for each identifier:

- Identifier value
- Symbolic name for the identifier

Example of a LIN PTT file

```
# -----
@FILE_VERSION = 1.0
@PROTOCOL_NAME = lin
# -----
# Labels for LIN protocol
#   Column order: Identifier, Label
# -----
# Labels for standard addresses
0x3F, Temperature
1Ch, Left brake
```

```

20h,Right brake
# Following ID is provided as integer
33,Mirror
0x37,Indoor lights
# Labels for reserved addresses
0x3C,Master_Request_Frame
0x3D,Slave_Response_Frame
# -----

```

For general information on label lists, see [Chapter 9.1.3, "Label Lists"](#), on page 180.

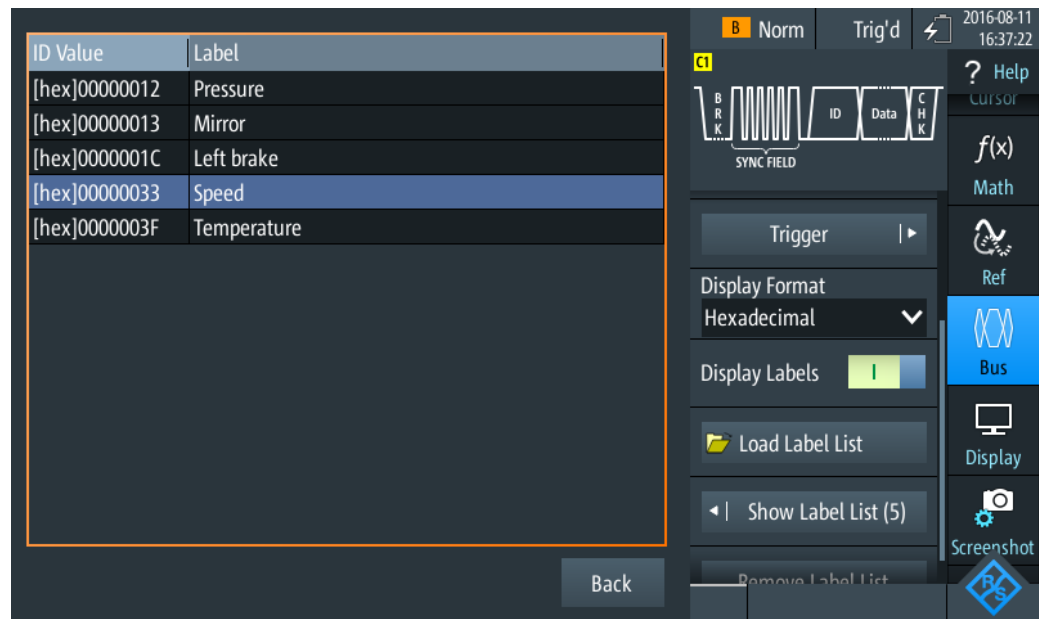

Figure 9-35: Display of a LIN label list

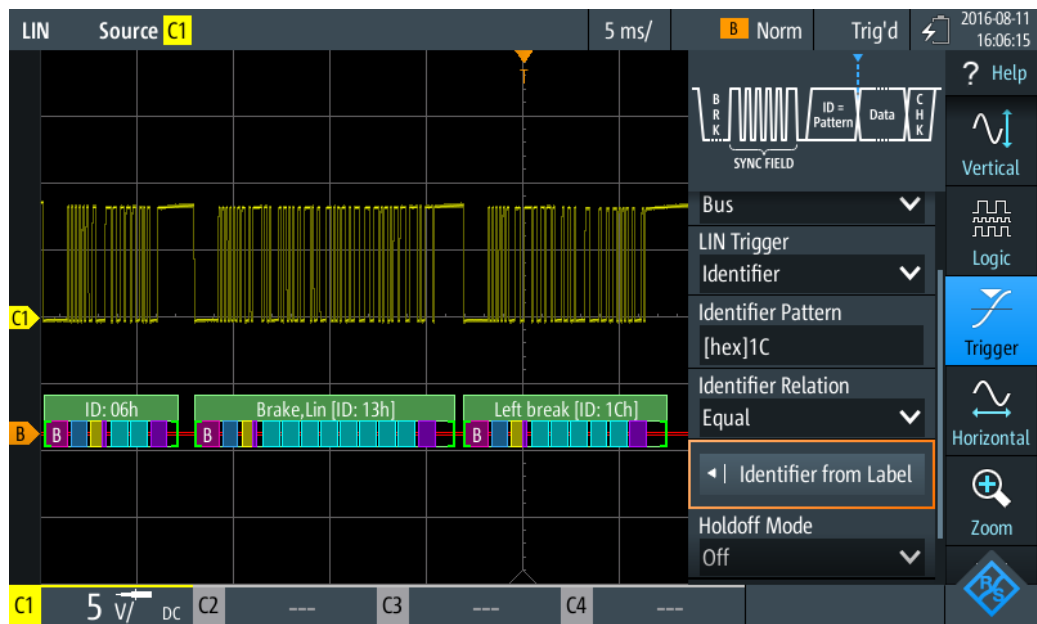

Figure 9-36: Trigger on identifier "Left brake"

9.6.5 LIN Decode Results

This chapter describes the comb display and the decode results table of decoded LIN buses. Basic information on decoding and display of decode results is given in [Chapter 9.1.2, "Decode Results"](#), on page 177.

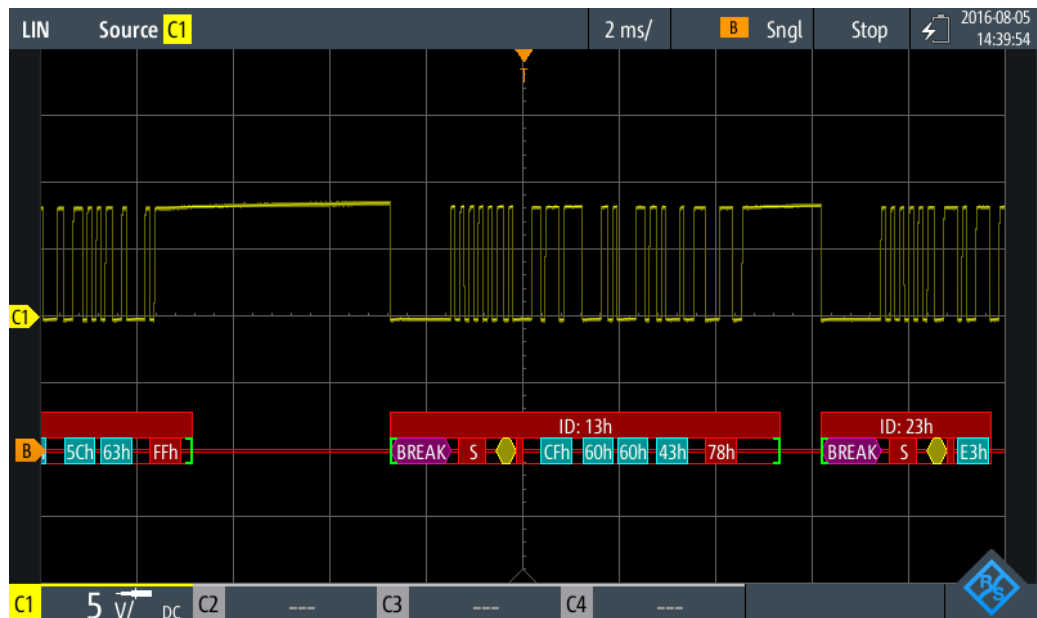

Figure 9-37: Comb display of a decoded LIN signal, triggered on parity error

The color-coding of the various protocol sections and errors simplifies the interpretation of the visual display.

Table 9-9: Color codes of decoded LIN signals

Color, display element	Description
Green brackets [...]	Start and end of frame
Green frame header	Data frame. Text indicates the frame ID (hex).
Magenta frame header	Wake-up frame. Text indicates the frame type.
Magenta comb	Break field
Blue comb	Synch field
Yellow comb	Identifier
Violet comb	Parity bit and checksum
Cyan comb	Data bytes
Red	Error in frame ID, checksum error, parity error, insufficient frame (end of acquisition before decoding has been completed)

In "Protocol" mode, decoded data is shown in tabular form.



Figure 9-38: Decoded LIN signal in Protocol mode

Table 9-10: Content of the protocol table for decoded LIN signal

Column	Description
#	Frame index
Frame Start	Time of frame start
ID [hex]	Identifier value, hexadecimal value

Column	Description
ID Label	Symbolic name of the identifier. Column is shown instead of "ID [hex]" if a label list is used.
ID P [bin]	Value of the protected identifier, binary value
Values 8 bit [format]	Values of data bytes. The data format is selected in the "Bus" menu.
CHK [hex]	Checksum value, hexadecimal value
State	Overall state of the frame. "Incomplete" indicates that the frame is not completely contained in the acquisition. Change the time scale, or move the reference point to the left to get a longer acquisition.

Remote control commands are described in [Chapter 15.11.6.3, "LIN Decode Results"](#), on page 474.

9.7 SENT (Option R&S RTH-K10)

9.7.1 The SENT Protocol

This chapter provides an overview of the protocol characteristics, encoding scheme, identifiers and trigger possibilities.

The SENT protocol transmits signal values point-to-point from a sensor to a controller (electronic control unit ECU), unidirectional. In contrast to conventional measurements, you can receive multiple data parameters via the SENT interface in a single transmission. Nevertheless, SENT is characterized by its simplicity and yet very high customizability to meet the individual requirements of the applications.

SENT operates via a three wire connection, a signal line, a supply voltage line for the sensor and a ground line. It transmits data digitally in variable timing units and evaluates the time between two falling edges (single edges). The signal is amplitude modulated with a constant amplitude voltage. Thus influences of interfering signals are not critical.

SENT key features

Main characteristics of SENT are:

- serial communication protocol
- 3 wires: SENT (signal line), 5V (voltage line), GND (ground line)
- output only, from sensor to receiver
- point-to-point transmission, no bus
- digital transmission
- high baud rate

- data transmission in variable timing units of 4 bits (1 nibble) between two falling edges
- transmitter-specific clock period (tick)
- time measured between single falling edges

9.7.1.1 SENT Transmission Concept

A sensor converts the analog measured data to a digital signal, and thus transmits a series of pulses to the receiver. The receiver, e.g. an ECU processes the received signal also digitally.

The format of a SENT message frame has a fixed pulse order and a transmitter-specific clock period. The total transmission time varies depending on the clock variation of the transmitter and the transmitted data values. The data pulses embedded in the transmission sequence represent one or multiple data parameters to be communicated. The last pulses in a message frame are the CRC check pulse, allowing the receiver to perform a number of diagnostic tests, and an optional pause pulse.

A SENT transmission starts without a request from the receiver. Consecutive sequences are transmitted continuously after the falling edge of the last pulse.

The SENT protocol distinguishes between two channel types:

- **Fast channel:** transmits primary data, i.e. sensor readings like temperature, pressure, mass air flow, throttle position.
- **Slow channel:** transmits secondary data consisting of transfer characteristics, sensor ID, type, manufacturer diagnostic, etc.
The slow channel transmission provides two serial message formats *Short* and *Enhanced* for customizing the secondary data.

The data of both, the fast and the slow channels is transmitted simultaneously, by including two bits of a slow channel message in the message frame of the fast channel. Even though it requires many fast channel messages to complete a slow channel message, you can use this function to transmit several slow channel messages with minimal impact on the primary sensor data and the data rate.

9.7.1.2 SENT Message Definitions

SENT terms

See the specific terms and definition used in SENT protocol:

- **Tick (clock tick):** basic unit of time
 - transmitter-specific nominal clock period
 - $3 \mu\text{s} < \text{clock tick} < 90 \mu\text{s}$, with max. 20 % clock variation
- **Nibble:** minimum unit of data
 - used to transmit data
 - variable timing units between two falling edges

SENT Fast Channel

The SENT protocol enables you to transmit measurements of multiple sensors in one transmission sequence with data signals of varying length. The diagram in [Figure 9-39](#) shows, for example, the encoding scheme for two 12-bit data signals.

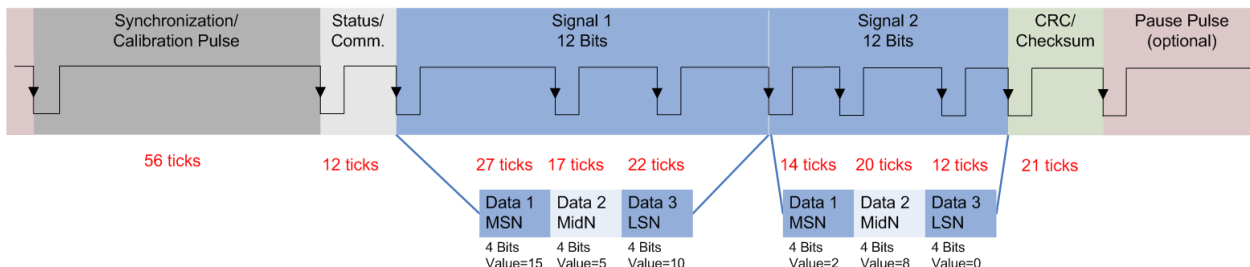

Figure 9-39: Example of a SENT transmission sequence

The format of a SENT transmission sequence consists of the following pulses:

- **Synchronization/Calibration Pulse:**
 - initial sequence of the receiver
 - the start condition is the falling edge of the last pulse (CRC or Pause)
 - nominal pulse period is 56 clock ticks
 - measures the actual clock variation of the transmitter and calculates the tick timing
- **Status/Communication Pulse (Nibble)**
 - one 4 bit pulse
 - communicates status and enables the sensor to include slow channel message bits
 - 0: (LSB) specific application
 - 1: specific application
 - 2: Serial Data message or specific application (e.g. Infineon TLE4998S)
 - 3: (MSB) 1= message start; 0=Serial Data message or specific application (e.g. Infineon TLE4998S)
 - 12 to 27 clock ticks
 - not included in CRC frame calculation
- **Data Pulses (Nibbles)**
 - one up to six 4 bit data nibbles
 - 12 to 27 clock ticks pulse period
 - initial logic 0 time with ≥ 5 ticks, subsequent logical 1 with variable duration
- **CRC/Checksum**
 - one 4 bit pulse
 - used for error checking of data nibbles (status nibble not included)
 - detects single bit, odd number of nonconsecutive and single burst errors
- **Pause Pulse**
 - one optional pulse
 - variable pulse length: 12 to 768 clock ticks

- can be used to create a transmission with constant number of clock ticks

SENT Slow Channel

Short Serial Messages

For transmission of a slow channel message, 2 bits are included in a fast channel message, see the status nibble (Bit 2,3) in [Figure 9-40](#).

A short serial message needs 16 fast channel messages until it is completely transmitted. Prerequisite for the complete transmission of the slow channel message are 16 consecutive error-free fast channel transmissions.

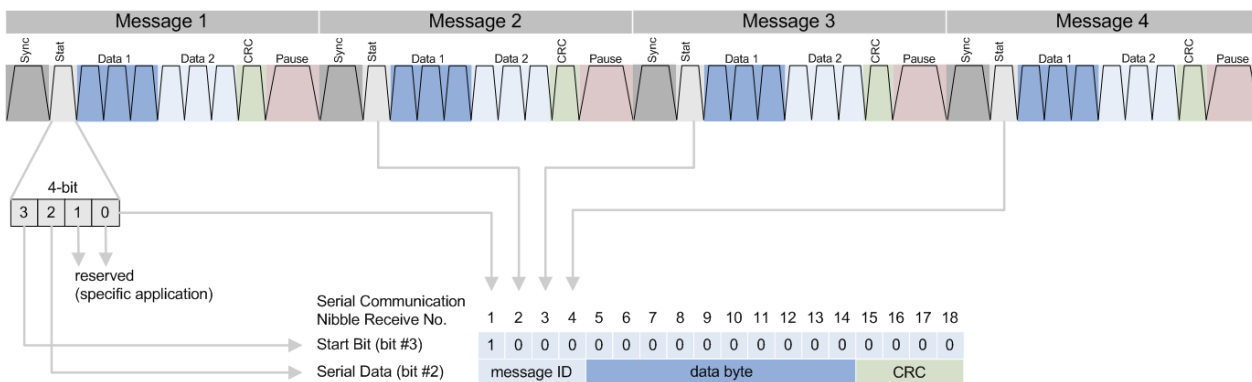

Figure 9-40: One serial message, composed of 16 SENT consecutive fast channel transmissions

Enhanced Serial Messages

The transmission of an enhanced serial message format requires 18 fast channel transmissions. Each slow channel message is assigned a message ID, which is transmitted with the data.

The enhanced serial message format provides two alternatives for configuring the message:

- 4 bit ID and 16 bit data
- 8 bit ID and 12 bit data

The graphs below illustrate the variants.

Table 9-11: Enhanced serial message formats

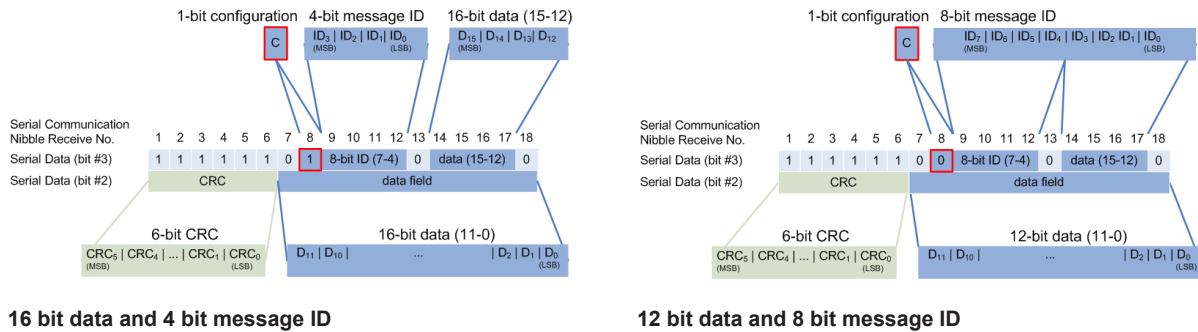

9.7.2 SENT Configuration Settings

Access: "Bus" menu > "Bus Protocol" = "SENT" > "Config"

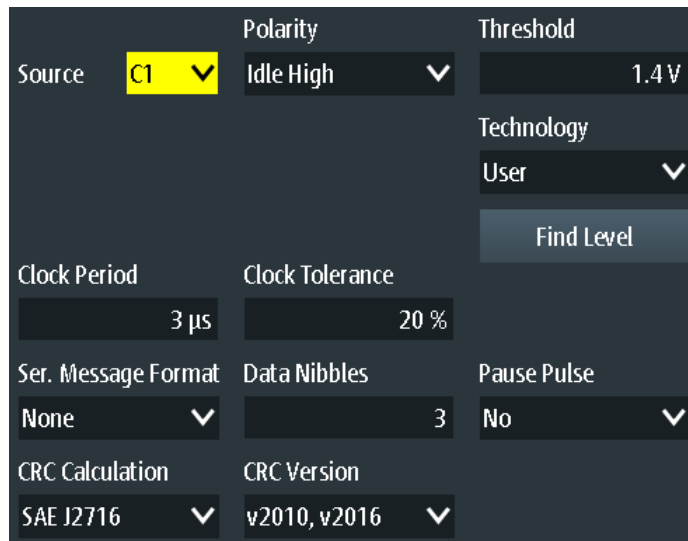

Source.....	234
Polarity.....	235
Threshold, Technology, Find Level.....	235
Clock Period.....	235
Clock Tolerance.....	235
Ser. Message Format.....	235
Data Nibbles.....	235
Pause Pulse.....	236
CRC Calculation.....	236
CRC Version.....	236
Frame Length.....	236

Source

Sets the source of the line. All active analog channels can be used.

If option R&S RTH-B1 is installed, digital channels can also be used as source.

Remote command:

[BUS:SENT:DATA:SOURce](#) on page 480

Polarity

Sets the idle state: "Idle Low" or "Idle High".

Remote command:

[BUS:SENT:POLarity](#) on page 480

Threshold, Technology, Find Level

Sets the threshold value for digitization of signals. If the signal value is higher than the threshold, the signal state is high. Otherwise, the signal state is considered low.

You can select the threshold voltages for various technologies in the "Technology" list, or set a user-defined value in "Threshold". You can also let the instrument set the appropriate threshold using "Find Level".

Changing the thresholds in the bus configuration changes also the thresholds of analog channels in the "Vertical" menu, or the thresholds of logic channels in the "Logic" menu.

Remote command:

[BUS:SENT:DATA:THReshold](#) on page 480

[BUS:SENT:TECHnology](#) on page 480

[BUS:SETReflevels](#) on page 432

[CHANnel<m>:THReshold:FINDlevel](#) on page 310

Clock Period

Sets the transmitter-specific nominal clock period (clock tick).

The clock period and signal length determine the speed of transmission.

Remote command:

[BUS:SENT:CLKPeriod](#) on page 481

Clock Tolerance

Specifies a tolerated deviation of the clock.

Remote command:

[BUS:SENT:CLKTolerance](#) on page 481

Ser. Message Format

Selects the protocol format in the transmitted signal.

"Short" Short serial messages.

"Enhanced" Enhanced serial messages.

"None" No serial messages. Transmission sequences only.

Remote command:

[BUS:SENT:SFORMAT](#) on page 482

Data Nibbles

Sets the number of data units in a single transmission sequence.

The maximum number of data nibbles is 6.

Remote command:

[BUS:SENT:DNIBbles](#) on page 481

Pause Pulse

Determines whether a pause pulse is transmitted after the checksum nibble.

You can use this pulse to create a transmission with a constant number of clock ticks. The pause pulse length can be between a minimum of 12 clock ticks up to 768 (3*256) ticks at a maximum.

"No"

No pause pulse between the transmission sequences.

"Yes"

Pause pulse with fixed length at the end of each transmission sequence.

The R&S RTH computes the length of the pause pulse automatically.

"Constant frame length"

Pause pulse with dynamic length to maintain a fixed transmission sequence length.

To define the constant frame length, set the number of clock ticks under "[Frame Length](#)" on page 236.

Remote command:

[BUS:SENT:PPULse](#) on page 482

CRC Calculation

Selects the method for CRC calculation.

SENT CRC calculates the checksum over all nibbles except the communication and status nibble.

"SAE_J2716" Calculates the CRC according to the SAE standard.

"TLE_4998X" Calculates the CRC according to the standard computing method for Infineon TLE_4998X sensors.

Remote command:

[BUS:SENT:CRMethod](#) on page 481

CRC Version

Selects the version the CRC check is based on.

"Legacy" Based on the CRC calculation version used earlier than 2010.

"v2010, v2016" Based on the recent CRC calculation version updated in 2010/2016.

Remote command:

[BUS:SENT:CRVersion](#) on page 481

Frame Length

Determines the frame length in terms of ticks. The dialog displays this settings parameter, if the signal has a constant frame length.

Remote command:

[BUS:SENT:PPFLength](#) on page 482

9.7.3 SENT Trigger Settings

Access: [Setup] ([Trigger]) > "Trigger type" = "Bus"



- SENT Trigger..... 237
- Status Pattern..... 238
- Status Relation..... 238
- Data Pattern..... 238
- Data Relation..... 238
- Identifier Pattern..... 238
- Identifier Relation..... 239
- Sync Pulse Error..... 239
- Pulse Period Error..... 239
- Fast CRC Error..... 239
- Slow CRC Error..... 239
- Frame Length Error..... 239

SENT Trigger

Sets the SENT trigger type. Depending on the selected value, different additional parameters are available.

- "Start of Frame"
 - Triggers at the end of the synchronization/calibration pulse.
- "Fast status"
 - Sets the trigger to a specific status or a specific pattern from the fast channel.
- "Fast status and data"
 - Sets the trigger to a combination of status and data condition from the fast channel. Triggers at the end of the last data nibble.
- "Slow Identifier"
 - Sets the trigger to a specific identifier or a specific pattern from the slow channel. The instrument triggers at the end of the last transmission sequence which includes the last serial bits of the slow channel.

"Slow Identifier and Data"

Sets the trigger to a combination of identifier and data condition from the slow channel. The instrument triggers at the end of the last transmission sequence which includes the last serial bits of the slow channel.

"Error condition"

Identifies various errors in the frame. You can select one or more error types as the trigger condition.

Remote command:

`TRIGger:SENT:TYPE` on page 483

Status Pattern

Specifies the status pattern to be found, in binary or hex format. Enter the pattern in MSB first bit order.

See also [Chapter 3.6.12.1, "Pattern Definition"](#), on page 72.

Remote command:

`TRIGger:SENT:STATus` on page 484

Status Relation

Defines how the specified status pattern is compared with the acquired signal. The instrument triggers if the acquired address is equal or unequal the defined pattern.

Remote command:

`TRIGger:SENT:SCONdition` on page 484

Data Pattern

Specifies the data pattern to be found, in binary or hex format. Enter the pattern in MSB first bit order.

See also [Chapter 3.6.12.1, "Pattern Definition"](#), on page 72.

Remote command:

`TRIGger:SENT:DATA` on page 483

Data Relation

Defines how the specified data pattern is compared with the acquired signal. The instrument triggers if the acquired address is equal or unequal the defined pattern.

Remote command:

`TRIGger:SENT:DCONdition` on page 483

Identifier Pattern

Specifies the identifier pattern to be found, in binary or hex format. Enter the pattern in MSB first bit order.

See also [Chapter 3.6.12.1, "Pattern Definition"](#), on page 72.

Remote command:

`TRIGger:SENT:IDENtifier` on page 484

Identifier Relation

Defines how the specified identifier pattern is compared with the acquired signal. The instrument triggers if the acquired address is equal or unequal the defined pattern.

Remote command:

[TRIGger:SENT:ICONdition](#) on page 484

Sync Pulse Error

Detects a synchronization/calibration pulse error in transmission sequences of the fast channel. An error occurs when:

- The duration of the synchronization/calibration pulse (in ticks) is less than $56 \cdot (1 - \text{clock tolerance})$ or more than $56 \cdot (1 + \text{clock tolerance})$.
- The synchronization/calibration pulse duration of frame $(n-1)$ varies by more than 1.5625% from the calibration/sync pulse duration of frame (n) .

Remote command:

[TRIGger:SENT:PULSeerror](#) on page 485

Pulse Period Error

Detects an error in the calibration/sync pulse in transmission sequences of the fast channel. An error occurs when a nibble has any of the following:

- Number of ticks at low is fewer than 4 ticks.
- Nibble value < 0 (fewer than 12 ticks) or > 15 (more than 27 ticks).

Through the pulse period error, you can also identify a nibble length error of the previous transmission sequence.

Remote command:

[TRIGger:SENT:PPERioderror](#) on page 485

Fast CRC Error

Detects a checksum error in the transmission sequences of the fast channel. The CRC length is 4 bits.

Remote command:

[TRIGger:SENT:FCRCerror](#) on page 484

Slow CRC Error

Detects a checksum error in serial messages of the slow channel. The CRC length is 4 bits for short serial messages, and 6 bit of enhanced serial messages.

Remote command:

[TRIGger:SENT:SCRCerror](#) on page 485

Frame Length Error

Detects frame length errors in transmission sequences when [Pause Pulse](#) is set to "Constant frame length".

A frame length error occurs, when the total length of the transmission sequence (including pause pulse) does not match the [Frame Length](#).

Remote command:

[TRIGger:SENT:IRFLength](#) on page 485

9.7.4 SENT Label List

For all protocols using ID or address identification, it is possible to create label lists containing addresses or IDs, a symbolic name for each node (symbolic label), and some protocol-specific information.

You can load label lists, and activate its usage for decoding. As a result, an additional "Label" column appears in the "Decode results" table, containing the symbolic label. The frame captions of the decoded signal show the symbolic label instead of the ID or address values. Hence it is easy to identify the messages of the different bus nodes.

You can also use the label list to trigger on an identifier or address. Instead of entering the value, you select the name, which is defined in the label list.

SENT label lists provide a useful way of translating the decoded data into user format. The label lists are highly customizable. The format of supplying the label list description is through a .xml file and is explained with an example, see ["Label list structure for SENT protocol"](#) on page 240.

For general information on the "Label List" tab, see [Chapter 9.1.3, "Label Lists"](#), on page 180.

Label list structure for SENT protocol

```
<sb:FRAME NAME="Diagnostic Error Codes" STATE="ON">
  <!-- Start of a Frame Definition -->
  <!-- This block defines the information of a Transmission Sequence
  or Serial Message:
  NAME => Symbolic Label of the Frame
  STATE [ON/OFF] => When ON, this frame Translation is taken into consideration.
  When OFF, this frame Translation is skipped.-->
<sb:DESCRIPTION> used to diagnose the current SENT System</sb:DESCRIPTION>
  <!-- Doesn't affect the Translation -->
<sb:ID-VALUE>01</sb:ID-VALUE>
  <!-- ID Value of the Serial Message (in decimal) -->
  <!-- Absence of the ID-VALUE field implies that the current Frame Translation
  is to be used for Transmission Sequences and not for a Serial Message -->
<sb:ID-LENGTH>8</sb:ID-LENGTH>
  <!-- ID Length of the Serial Message (in bits) -->
<sb:DATA-SIZE>12</sb:DATA-SIZE>
  <!-- Data Length of the Serial Message (in bits) -->
<sb:SIGNALS>
  <!-- This block defines the information of the Signals embedded
  in the Data Field of the Frame (Transmission Sequence or Serial Message) -->
<sb:SIGNAL ID="Diagnostic">
  <!-- Unique ID of the Signal (no effect on Translation) -->
<sb:SHORT-NAME>Diagnostic Code</sb:SHORT-NAME>
  <!-- Name of the Signal -->
<sb:DESCRIPTION></sb:DESCRIPTION>
  <!-- Info Field (no effect on Translation) -->
```

```

<sb:BIT-POSITION>11</sb:BIT-POSITION>
  <!-- Ending Bit position of the Signal
  (The whole Data Field is represented as MSB -> LSB Sequence) -->
<sb:BIT-LENGTH>12</sb:BIT-LENGTH>
  <!-- Number of Bits representing the Signal Value -->
<sb:BYTE-ORDER>MSB</sb:BYTE-ORDER>
  <!-- Byte Order of the Signal Value [MSB or LSB], Default: MSB -->
<sb:VALUE-TYPE>ENUM</sb:VALUE-TYPE>
  <!-- Representation of the Bits [ENUM, UNSIGNED_INT, INT, FLOAT, DOUBLE],
  Default: UNSIGNED_INT
  The Signal Value is calculated according to the following:
  Translated_Value = Encoded_Value * FACTOR + OFFSET -->
<sb:FACTOR>1.0</sb:FACTOR>
  <!-- Signal Factor (decimal value)-->
<sb:OFFSET>0.0</sb:OFFSET>
  <!-- Signal Offset (decimal value)-->
<sb:MIN>0</sb:MIN>
  <!-- Minimum Signal Value (decimal value) -->
<sb:MAX>4096</sb:MAX>
  <!-- Maximum Signal Value (decimal value) -->
<sb:ENUM-VALUES>
  <!-- This block is only valid (and taken into consideration)
  when the VALUE-TYPE is ENUM
  It defines the Enumeration List Translation of the Signal -->
<sb:ENUM INDEX="0" LABEL="No Error"/>
  <!-- INDEX is the Enum Value (corresponds to the Signal Value in decimal),
  LABEL is the matching Translated Signal Value -->
<sb:ENUM INDEX="1" LABEL="Channel 1 out of range high"/>
</sb:ENUM-VALUES>
  <!-- End of Signal Enumeration List Definition -->
</sb:SIGNAL>
  <!-- End of a Signal Definition -->
  <!-- More Signals can be defined here! -->
</sb:SIGNALS>
  <!-- End of list of Signals Definition -->
</sb:FRAME>
  <!-- End of Frame Definition -->

```

For an example to label list translation, see [Chapter 9.7.4.1, "SENT Label List Translation Example"](#), on page 242.

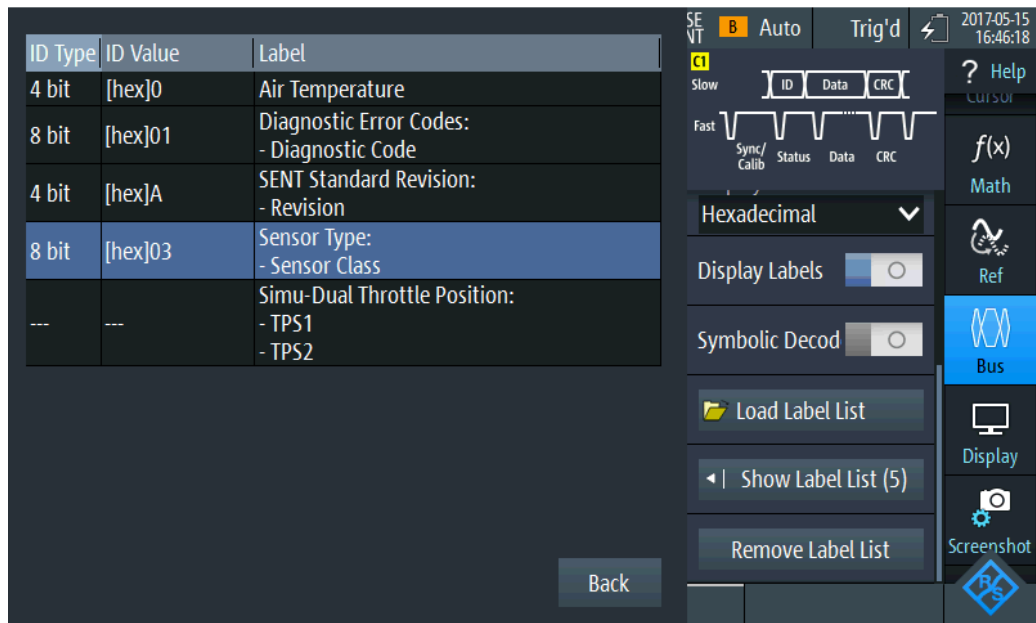

Figure 9-41: SENT label list

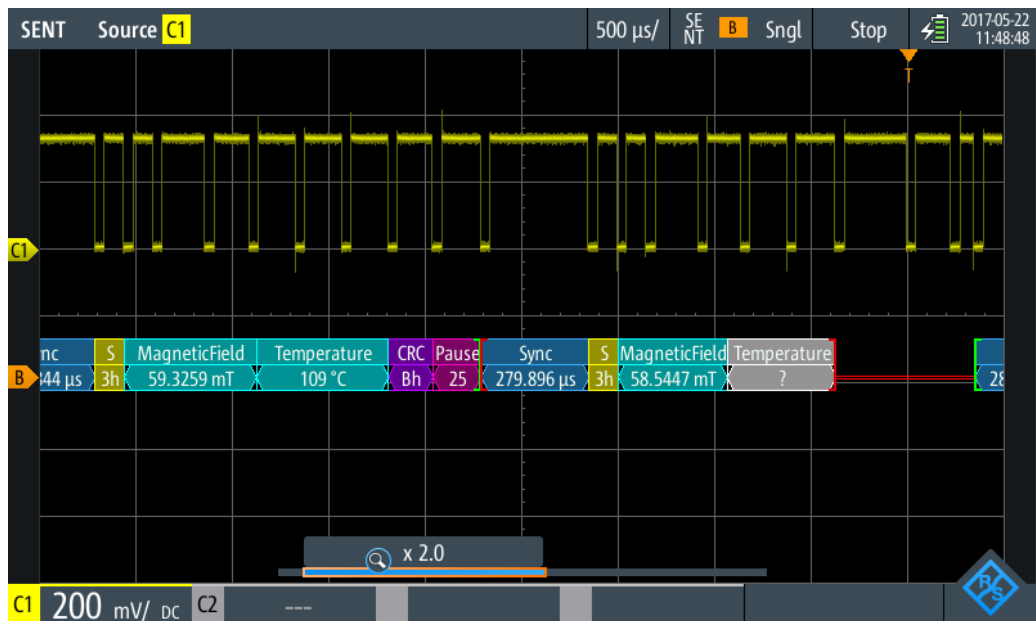

Figure 9-42: SENT decode results with label list translation

Remote command:

`BUS:SENT:FRAMe<m>:SYMBOL?` on page 490

9.7.4.1 SENT Label List Translation Example

The example shows the `xm1` sequence for a label list translation in the SENT protocol:

```

<?xml version="1.0" encoding="UTF-8"?>
<sb:LABEL-LIST-FILE>
  <sb:PROJECT ID="SENT-TRANSLATION SYSTEM">
    <sb:SHORT-NAME>SENT</sb:SHORT-NAME>
    <sb:LONG-NAME>SENT-Translation System Demo</sb:LONG-NAME>
    <sb:DESCRIPTION>This is the database for Translation demo for SENT.</sb:DESCRIPTION>
  </sb:PROJECT>
  <sb:FRAMES>
    <sb:FRAME NAME="Air Temperature" STATE="ON">
      <sb:DESCRIPTION></sb:DESCRIPTION>
      <sb:ID-VALUE>0</sb:ID-VALUE>
      <sb:ID-LENGTH>4</sb:ID-LENGTH>
      <sb:DATA-SIZE>16</sb:DATA-SIZE>
    </sb:FRAME>
    <sb:FRAME NAME="Humidity" STATE="OFF">
      <sb:DESCRIPTION></sb:DESCRIPTION>
      <sb:ID-VALUE>2</sb:ID-VALUE>
      <sb:ID-LENGTH>4</sb:ID-LENGTH>
      <sb:DATA-SIZE>16</sb:DATA-SIZE>
    </sb:FRAME>
    <sb:FRAME NAME="Barometric Pressure" STATE="OFF">
      <sb:DESCRIPTION></sb:DESCRIPTION>
      <sb:ID-VALUE>4</sb:ID-VALUE>
      <sb:ID-LENGTH>4</sb:ID-LENGTH>
      <sb:DATA-SIZE>16</sb:DATA-SIZE>
    </sb:FRAME>
    <sb:FRAME NAME="Configuration Code" STATE="OFF">
      <sb:DESCRIPTION></sb:DESCRIPTION>
      <sb:ID-VALUE>04</sb:ID-VALUE>
      <sb:ID-LENGTH>8</sb:ID-LENGTH>
      <sb:DATA-SIZE>12</sb:DATA-SIZE>
    </sb:FRAME>
    <sb:FRAME NAME="Manufacturer Code" STATE="OFF">
      <sb:DESCRIPTION></sb:DESCRIPTION>
      <sb:ID-VALUE>05</sb:ID-VALUE>
      <sb:ID-LENGTH>8</sb:ID-LENGTH>
      <sb:DATA-SIZE>12</sb:DATA-SIZE>
    </sb:FRAME>
    <sb:FRAME NAME="Sensor Type" STATE="ON">
      <sb:DESCRIPTION>specifies the SENT Sensor Type</sb:DESCRIPTION>
      <sb:ID-VALUE>03</sb:ID-VALUE>
      <sb:ID-LENGTH>8</sb:ID-LENGTH>
      <sb:DATA-SIZE>12</sb:DATA-SIZE>
      <sb:SIGNALS>
        <sb:SIGNAL ID="Sensor Class">
          <sb:SHORT-NAME>Sensor Class</sb:SHORT-NAME>
          <sb:BIT-POSITION>11</sb:BIT-POSITION>
          <sb:BIT-LENGTH>12</sb:BIT-LENGTH>
          <sb:BYTE-ORDER>MSB</sb:BYTE-ORDER>
          <sb:VALUE-TYPE>ENUM</sb:VALUE-TYPE>
        </sb:SIGNAL>
      </sb:SIGNALS>
    </sb:FRAME>
  </sb:FRAMES>
</sb:LABEL-LIST-FILE>

```

```

<sb:FACTOR>1.0</sb:FACTOR>
<sb:OFFSET>0.0</sb:OFFSET>
<sb:MIN>0</sb:MIN>
<sb:MAX>32.0</sb:MAX>
<sb:ENUM-VALUES>
  <sb:ENUM INDEX="0" LABEL="Not Specified"/>
  <sb:ENUM INDEX="1" LABEL="P"/>
  <sb:ENUM INDEX="2" LABEL="P/-"/>
  <sb:ENUM INDEX="3" LABEL="P/S"/>
  <sb:ENUM INDEX="4" LABEL="P/S/Default T"/>
  <sb:ENUM INDEX="5" LABEL="P/S/Sensor-Specific T"/>
  <sb:ENUM INDEX="6" LABEL="P1/P2"/>
  <sb:ENUM INDEX="7" LABEL="P/Default T"/>
  <sb:ENUM INDEX="8" LABEL="P/Sensor-Specific T"/>
  <sb:ENUM INDEX="9" LABEL="P1/P2/Default T"/>
  <sb:ENUM INDEX="10" LABEL="P1/P2/Sensor-Specific T"/>
  <sb:ENUM INDEX="16" LABEL="Not Defined"/>
  <sb:ENUM INDEX="17" LABEL="MAF (hi-res,lin)"/>
  <sb:ENUM INDEX="18" LABEL="MAF (hi-res,non-lin)"/>
  <sb:ENUM INDEX="19" LABEL="MAF (hi-res,lin) / Pressure"/>
  <sb:ENUM INDEX="20" LABEL="MAF (hi-res,non-lin) / Pressure"/>
  <sb:ENUM INDEX="21" LABEL="MAF (lin) / Pressure (hi-res)"/>
  <sb:ENUM INDEX="22" LABEL="MAF (non-lin) / Pressure (hi-res)"/>
</sb:ENUM-VALUES>
</sb:SIGNAL>
</sb:SIGNALS>
</sb:FRAME>
<sb:FRAME NAME="SENT Standard Revision" STATE="ON">
  <sb:SHORT-NAME>SENT Standard</sb:SHORT-NAME>
  <sb:DESCRIPTION>specifies the SENT Standard Revision Number</sb:DESCRIPTION>
  <sb:ID-VALUE>10</sb:ID-VALUE>
  <sb:ID-LENGTH>4</sb:ID-LENGTH>
  <sb:DATA-SIZE>8</sb:DATA-SIZE>
  <sb:SIGNALS>
    <sb:SIGNAL ID="Revision">
      <sb:SHORT-NAME>Revision</sb:SHORT-NAME>
      <sb:DESCRIPTION>SENT-Standard Revision Number</sb:DESCRIPTION>
      <sb:BIT-POSITION>7</sb:BIT-POSITION>
      <sb:BIT-LENGTH>8</sb:BIT-LENGTH>
      <sb:BYTE-ORDER>MSB</sb:BYTE-ORDER>
      <sb:VALUE-TYPE>ENUM</sb:VALUE-TYPE>
      <sb:FACTOR>1.0</sb:FACTOR>
      <sb:OFFSET>0.0</sb:OFFSET>
      <sb:MIN>0</sb:MIN>
      <sb:MAX>4.0</sb:MAX>
      <sb:ENUM-VALUES>
        <sb:ENUM INDEX="0" LABEL="Not defined"/>
        <sb:ENUM INDEX="1" LABEL="J2716 Rev 1"/>
        <sb:ENUM INDEX="2" LABEL="J2716 Rev 2"/>
        <sb:ENUM INDEX="3" LABEL="J2716 Rev 3"/>
      </sb:ENUM-VALUES>
    </sb:SIGNAL>
  </sb:SIGNALS>
</sb:FRAME>

```



```

        </sb:ENUM-VALUES>
    </sb:SIGNAL>
</sb:SIGNALS>
</sb:FRAME>
<sb:FRAME NAME="Diagnostic Error Codes" STATE="ON">
    <sb:DESCRIPTION>used to diagnose the current SENT System</sb:DESCRIPTION>
    <sb:ID-VALUE>01</sb:ID-VALUE>
    <sb:ID-LENGTH>8</sb:ID-LENGTH>
    <sb:DATA-SIZE>12</sb:DATA-SIZE>
    <sb:SIGNALS>
        <sb:SIGNAL ID="Diagnostic">
            <sb:SHORT-NAME>Diagnostic Code</sb:SHORT-NAME>
            <sb:DESCRIPTION></sb:DESCRIPTION>
            <sb:BIT-POSITION>11</sb:BIT-POSITION>
            <sb:BIT-LENGTH>12</sb:BIT-LENGTH>
            <sb:BYTE-ORDER>MSB</sb:BYTE-ORDER>
            <sb:VALUE-TYPE>ENUM</sb:VALUE-TYPE>
            <sb:FACTOR>1.0</sb:FACTOR>
            <sb:OFFSET>0.0</sb:OFFSET>
            <sb:MIN>0</sb:MIN>
            <sb:MAX>4096</sb:MAX>
            <sb:ENUM-VALUES>
                <sb:ENUM INDEX="0" LABEL="No Error"/>
                <sb:ENUM INDEX="1" LABEL="Channel 1 out of range high"/>
                <sb:ENUM INDEX="2" LABEL="Channel 1 out of range low"/>
                <sb:ENUM INDEX="3" LABEL="Initialization Error (Channel 1)"/>
                <sb:ENUM INDEX="4" LABEL="Channel 2 out of range high"/>
                <sb:ENUM INDEX="5" LABEL="Channel 2 out of range low"/>
                <sb:ENUM INDEX="6" LABEL="Initialization Error (Channel 2)"/>
                <sb:ENUM INDEX="7" LABEL="Channel 1 and 2 Rationality Error"/>
                <sb:ENUM INDEX="1025" LABEL="Slow Channel Temperature out of range high"/>
                <sb:ENUM INDEX="1026" LABEL="Slow Channel Temperature out of range low"/>
                <sb:ENUM INDEX="1027" LABEL="Slow Channel Temperature initialization error"/>
                <sb:ENUM INDEX="1028" LABEL="Slow Channel Humidity out of range high"/>
                <sb:ENUM INDEX="1029" LABEL="Slow Channel Humidity out of range low"/>
                <sb:ENUM INDEX="1030" LABEL="Slow Channel Humidity initialization error"/>
                <sb:ENUM INDEX="1031" LABEL="Slow Channel Barometric Pressure out of range high"/>
                <sb:ENUM INDEX="1032" LABEL="Slow Channel Barometric Pressure out of range low"/>
                <sb:ENUM INDEX="1033" LABEL="Slow Channel Barometric Pressure initialization error"/>
            </sb:ENUM-VALUES>
        </sb:SIGNAL>
    </sb:SIGNALS>
</sb:FRAME>
<sb:FRAME NAME="Simu-Dual Throttle Position" STATE="ON">
    <sb:SHORT-NAME>DTP</sb:SHORT-NAME>
    <sb:DATA-SIZE>20</sb:DATA-SIZE>
    <sb:SIGNALS>
        <sb:SIGNAL ID="Channel_1">
            <sb:SHORT-NAME>TPS1</sb:SHORT-NAME>
            <sb:DESCRIPTION>"</sb:DESCRIPTION>

```

```

<sb:BIT-POSITION>19</sb:BIT-POSITION>
<sb:BIT-LENGTH>12</sb:BIT-LENGTH>
<sb:BYTE-ORDER>MSB</sb:BYTE-ORDER>
<sb:VALUE-TYPE>UNSIGNED_INT</sb:VALUE-TYPE>
<sb:FACTOR>1.0</sb:FACTOR>
<sb:OFFSET>0.0</sb:OFFSET>
<sb:MIN>0</sb:MIN>
<sb:MAX>10000.0</sb:MAX>
<sb:UNIT></sb:UNIT>
</sb:SIGNAL>
<sb:SIGNAL ID="Channel_2">
  <sb:SHORT-NAME>TPS2</sb:SHORT-NAME>
  <sb:DESCRIPTION>"</sb:DESCRIPTION>
  <sb:BIT-POSITION>7</sb:BIT-POSITION>
  <sb:BIT-LENGTH>8</sb:BIT-LENGTH>
  <sb:BYTE-ORDER>LSB</sb:BYTE-ORDER>
  <sb:FACTOR>1.0</sb:FACTOR>
  <sb:OFFSET>0.0</sb:OFFSET>
  <sb:MIN>0</sb:MIN>
  <sb:MAX>10000.0</sb:MAX>
  <sb:UNIT></sb:UNIT>
</sb:SIGNAL>
</sb:SIGNALS>
</sb:FRAME>
<sb:FRAME NAME="Dual Throttle Position" STATE="OFF">
  <sb:SHORT-NAME>DTP</sb:SHORT-NAME>
  <sb:DATA-SIZE>24</sb:DATA-SIZE>
  <sb:SIGNALS>
    <sb:SIGNAL ID="Channel_1">
      <sb:SHORT-NAME>TPS1</sb:SHORT-NAME>
      <sb:DESCRIPTION>"</sb:DESCRIPTION>
      <sb:BIT-POSITION>23</sb:BIT-POSITION>
      <sb:BIT-LENGTH>12</sb:BIT-LENGTH>
      <sb:BYTE-ORDER>MSB</sb:BYTE-ORDER>
      <sb:VALUE-TYPE>UNSIGNED_INT</sb:VALUE-TYPE>
      <sb:FACTOR>1.0</sb:FACTOR>
      <sb:OFFSET>0.0</sb:OFFSET>
      <sb:MIN>0</sb:MIN>
      <sb:MAX>10000.0</sb:MAX>
      <sb:UNIT></sb:UNIT>
    </sb:SIGNAL>
    <sb:SIGNAL ID="Channel_2">
      <sb:SHORT-NAME>TPS2</sb:SHORT-NAME>
      <sb:DESCRIPTION>"</sb:DESCRIPTION>
      <sb:BIT-POSITION>11</sb:BIT-POSITION>
      <sb:BIT-LENGTH>12</sb:BIT-LENGTH>
      <sb:BYTE-ORDER>LSB</sb:BYTE-ORDER>
      <sb:FACTOR>1.0</sb:FACTOR>
      <sb:OFFSET>0.0</sb:OFFSET>
      <sb:MIN>0</sb:MIN>

```

```

    <sb:MAX>10000.0</sb:MAX>
    <sb:UNIT></sb:UNIT>
  </sb:SIGNAL>
</sb:SIGNALS>
</sb:FRAME>
<sb:FRAME NAME="Mass Air Flow (16)" STATE="OFF">
  <sb:SHORT-NAME>MAF/P</sb:SHORT-NAME>
  <sb:DATA-SIZE>24</sb:DATA-SIZE>
  <sb:SIGNALS>
    <sb:SIGNAL ID="Channel_1">
      <sb:SHORT-NAME>MAF</sb:SHORT-NAME>
      <sb:DESCRIPTION>"</sb:DESCRIPTION>
      <sb:BIT-POSITION>23</sb:BIT-POSITION>
      <sb:BIT-LENGTH>16</sb:BIT-LENGTH>
      <sb:BYTE-ORDER>MSB</sb:BYTE-ORDER>
      <sb:FACTOR>1.0</sb:FACTOR>
      <sb:OFFSET>0.0</sb:OFFSET>
      <sb:MIN>0</sb:MIN>
      <sb:MAX>10000.0</sb:MAX>
      <sb:UNIT></sb:UNIT>
    </sb:SIGNAL>
  </sb:SIGNALS>
</sb:FRAME>
<sb:FRAME NAME="Mass Air Flow (16/8)" STATE="OFF">
  <sb:SHORT-NAME>MAF/P</sb:SHORT-NAME>
  <sb:DATA-SIZE>24</sb:DATA-SIZE>
  <sb:SIGNALS>
    <sb:SIGNAL ID="Channel_1">
      <sb:SHORT-NAME>MAF</sb:SHORT-NAME>
      <sb:DESCRIPTION>"</sb:DESCRIPTION>
      <sb:BIT-POSITION>23</sb:BIT-POSITION>
      <sb:BIT-LENGTH>16</sb:BIT-LENGTH>
      <sb:BYTE-ORDER>MSB</sb:BYTE-ORDER>
      <sb:FACTOR>1.0</sb:FACTOR>
      <sb:OFFSET>0.0</sb:OFFSET>
      <sb:MIN>0</sb:MIN>
      <sb:MAX>10000.0</sb:MAX>
      <sb:UNIT></sb:UNIT>
    </sb:SIGNAL>
    <sb:SIGNAL ID="Channel_2">
      <sb:SHORT-NAME>Pressure</sb:SHORT-NAME>
      <sb:DESCRIPTION>"</sb:DESCRIPTION>
      <sb:BIT-POSITION>7</sb:BIT-POSITION>
      <sb:BIT-LENGTH>8</sb:BIT-LENGTH>
      <sb:BYTE-ORDER>LSB</sb:BYTE-ORDER>
      <sb:FACTOR>1.0</sb:FACTOR>
      <sb:OFFSET>0.0</sb:OFFSET>
      <sb:MIN>0</sb:MIN>
      <sb:MAX>10000.0</sb:MAX>
      <sb:UNIT></sb:UNIT>
    </sb:SIGNAL>
  </sb:SIGNALS>
</sb:FRAME>

```

```

    </sb:SIGNAL>
  </sb:SIGNALS>
</sb:FRAME>
<sb:FRAME NAME="Mass Air Flow (14/10)" STATE="OFF">
  <sb:SHORT-NAME>MAF/P</sb:SHORT-NAME>
  <sb:DATA-SIZE>24</sb:DATA-SIZE>
  <sb:SIGNALS>
    <sb:SIGNAL ID="Channel_1">
      <sb:SHORT-NAME>MAF</sb:SHORT-NAME>
      <sb:DESCRIPTION>"</sb:DESCRIPTION>
      <sb:BIT-POSITION>23</sb:BIT-POSITION>
      <sb:BIT-LENGTH>14</sb:BIT-LENGTH>
      <sb:BYTE-ORDER>MSB</sb:BYTE-ORDER>
      <sb:FACTOR>1.0</sb:FACTOR>
      <sb:OFFSET>0.0</sb:OFFSET>
      <sb:MIN>0</sb:MIN>
      <sb:MAX>10000.0</sb:MAX>
      <sb:UNIT></sb:UNIT>
    </sb:SIGNAL>
    <sb:SIGNAL ID="Channel_2">
      <sb:SHORT-NAME>Pressure</sb:SHORT-NAME>
      <sb:DESCRIPTION>"</sb:DESCRIPTION>
      <sb:BIT-POSITION>9</sb:BIT-POSITION>
      <sb:BIT-LENGTH>10</sb:BIT-LENGTH>
      <sb:BYTE-ORDER>LSB</sb:BYTE-ORDER>
      <sb:FACTOR>1.0</sb:FACTOR>
      <sb:OFFSET>0.0</sb:OFFSET>
      <sb:MIN>0</sb:MIN>
      <sb:MAX>10000.0</sb:MAX>
      <sb:UNIT></sb:UNIT>
    </sb:SIGNAL>
  </sb:SIGNALS>
</sb:FRAME>
<sb:FRAME NAME="Single Secure Sensor" STATE="OFF">
  <sb:SHORT-NAME>SSS</sb:SHORT-NAME>
  <sb:DATA-SIZE>24</sb:DATA-SIZE>
  <sb:SIGNALS>
    <sb:SIGNAL ID="Channel_1">
      <sb:SHORT-NAME>Ch1</sb:SHORT-NAME>
      <sb:DESCRIPTION>"</sb:DESCRIPTION>
      <sb:BIT-POSITION>23</sb:BIT-POSITION>
      <sb:BIT-LENGTH>12</sb:BIT-LENGTH>
      <sb:BYTE-ORDER>MSB</sb:BYTE-ORDER>
      <sb:FACTOR>1.0</sb:FACTOR>
      <sb:OFFSET>0.0</sb:OFFSET>
      <sb:MIN>0</sb:MIN>
      <sb:MAX>10000.0</sb:MAX>
      <sb:UNIT></sb:UNIT>
    </sb:SIGNAL>
    <sb:SIGNAL ID="Channel_2">

```

```

    <sb:SHORT-NAME>Counter</sb:SHORT-NAME>
    <sb:DESCRIPTION>""</sb:DESCRIPTION>
    <sb:BIT-POSITION>11</sb:BIT-POSITION>
    <sb:BIT-LENGTH>8</sb:BIT-LENGTH>
    <sb:BYTE-ORDER>MSB</sb:BYTE-ORDER>
    <sb:FACTOR>1.0</sb:FACTOR>
    <sb:OFFSET>0.0</sb:OFFSET>
    <sb:MIN>0</sb:MIN>
    <sb:MAX>256.0</sb:MAX>
    <sb:UNIT></sb:UNIT>
  </sb:SIGNAL>
</sb:SIGNALS>
</sb:FRAME>
<sb:FRAME NAME="Pressure Sensor" STATE="OFF">
  <sb:SHORT-NAME>P</sb:SHORT-NAME>
  <sb:DATA-SIZE>24</sb:DATA-SIZE>
  <sb:SIGNALS>
    <sb:SIGNAL ID="Channel_1">
      <sb:SHORT-NAME>Pressure1</sb:SHORT-NAME>
      <sb:DESCRIPTION>""</sb:DESCRIPTION>
      <sb:BIT-POSITION>23</sb:BIT-POSITION>
      <sb:BIT-LENGTH>12</sb:BIT-LENGTH>
      <sb:BYTE-ORDER>MSB</sb:BYTE-ORDER>
      <sb:FACTOR>1.0</sb:FACTOR>
      <sb:OFFSET>0.0</sb:OFFSET>
      <sb:MIN>0</sb:MIN>
      <sb:MAX>10000.0</sb:MAX>
      <sb:UNIT></sb:UNIT>
    </sb:SIGNAL>
    <sb:SIGNAL ID="Channel_2">
      <sb:SHORT-NAME>Pressure2</sb:SHORT-NAME>
      <sb:DESCRIPTION>""</sb:DESCRIPTION>
      <sb:BIT-POSITION>11</sb:BIT-POSITION>
      <sb:BIT-LENGTH>12</sb:BIT-LENGTH>
      <sb:BYTE-ORDER>LSB</sb:BYTE-ORDER>
      <sb:FACTOR>1.0</sb:FACTOR>
      <sb:OFFSET>0.0</sb:OFFSET>
      <sb:MIN>0</sb:MIN>
      <sb:MAX>10000.0</sb:MAX>
      <sb:UNIT></sb:UNIT>
    </sb:SIGNAL>
  </sb:SIGNALS>
</sb:FRAME>
<sb:FRAME NAME="Pressure and Temperature Sensor" STATE="OFF">
  <sb:SHORT-NAME>P/T</sb:SHORT-NAME>
  <sb:DATA-SIZE>24</sb:DATA-SIZE>
  <sb:SIGNALS>
    <sb:SIGNAL ID="Channel_1">
      <sb:SHORT-NAME>Pressure</sb:SHORT-NAME>
      <sb:DESCRIPTION>""</sb:DESCRIPTION>

```

```

    <sb:BIT-POSITION>23</sb:BIT-POSITION>
    <sb:BIT-LENGTH>12</sb:BIT-LENGTH>
    <sb:BYTE-ORDER>MSB</sb:BYTE-ORDER>
    <sb:FACTOR>1.0</sb:FACTOR>
    <sb:OFFSET>0.0</sb:OFFSET>
    <sb:MIN>0</sb:MIN>
    <sb:MAX>10000.0</sb:MAX>
    <sb:UNIT></sb:UNIT>
  </sb:SIGNAL>
  <sb:SIGNAL ID="Channel_2">
    <sb:SHORT-NAME>Temperature</sb:SHORT-NAME>
    <sb:DESCRIPTION>"</sb:DESCRIPTION>
    <sb:BIT-POSITION>11</sb:BIT-POSITION>
    <sb:BIT-LENGTH>12</sb:BIT-LENGTH>
    <sb:BYTE-ORDER>LSB</sb:BYTE-ORDER>
    <sb:FACTOR>1.0</sb:FACTOR>
    <sb:OFFSET>0.0</sb:OFFSET>
    <sb:MIN>0</sb:MIN>
    <sb:MAX>10000.0</sb:MAX>
    <sb:UNIT></sb:UNIT>
  </sb:SIGNAL>
</sb:SIGNALS>
</sb:FRAME>
<sb:FRAME NAME="Pressure and Secure Sensor" STATE="OFF">
  <sb:SHORT-NAME>P/S</sb:SHORT-NAME>
  <sb:DATA-SIZE>24</sb:DATA-SIZE>
  <sb:SIGNALS>
    <sb:SIGNAL ID="Channel_1">
      <sb:SHORT-NAME>Pressure</sb:SHORT-NAME>
      <sb:DESCRIPTION>"</sb:DESCRIPTION>
      <sb:BIT-POSITION>23</sb:BIT-POSITION>
      <sb:BIT-LENGTH>12</sb:BIT-LENGTH>
      <sb:BYTE-ORDER>MSB</sb:BYTE-ORDER>
      <sb:FACTOR>1.0</sb:FACTOR>
      <sb:OFFSET>0.0</sb:OFFSET>
      <sb:MIN>0</sb:MIN>
      <sb:MAX>10000.0</sb:MAX>
      <sb:UNIT></sb:UNIT>
    </sb:SIGNAL>
    <sb:SIGNAL ID="Channel_2">
      <sb:SHORT-NAME>Counter</sb:SHORT-NAME>
      <sb:DESCRIPTION>"</sb:DESCRIPTION>
      <sb:BIT-POSITION>11</sb:BIT-POSITION>
      <sb:BIT-LENGTH>8</sb:BIT-LENGTH>
      <sb:BYTE-ORDER>MSB</sb:BYTE-ORDER>
      <sb:FACTOR>1.0</sb:FACTOR>
      <sb:OFFSET>0.0</sb:OFFSET>
      <sb:MIN>0</sb:MIN>
      <sb:MAX>10000.0</sb:MAX>
      <sb:UNIT></sb:UNIT>
    </sb:SIGNAL>
  </sb:SIGNALS>
</sb:FRAME>

```

```

</sb:SIGNAL>
</sb:SIGNALS>
</sb:FRAME>
</sb:FRAMES>
</sb:LABEL-LIST-FILE>

```

9.7.5 SENT Decode Results

This chapter describes the comb display and the decode results table of decoded SENT buses. Basic information on decoding and display of decode results is given in [Chapter 9.1.2, "Decode Results"](#), on page 177.

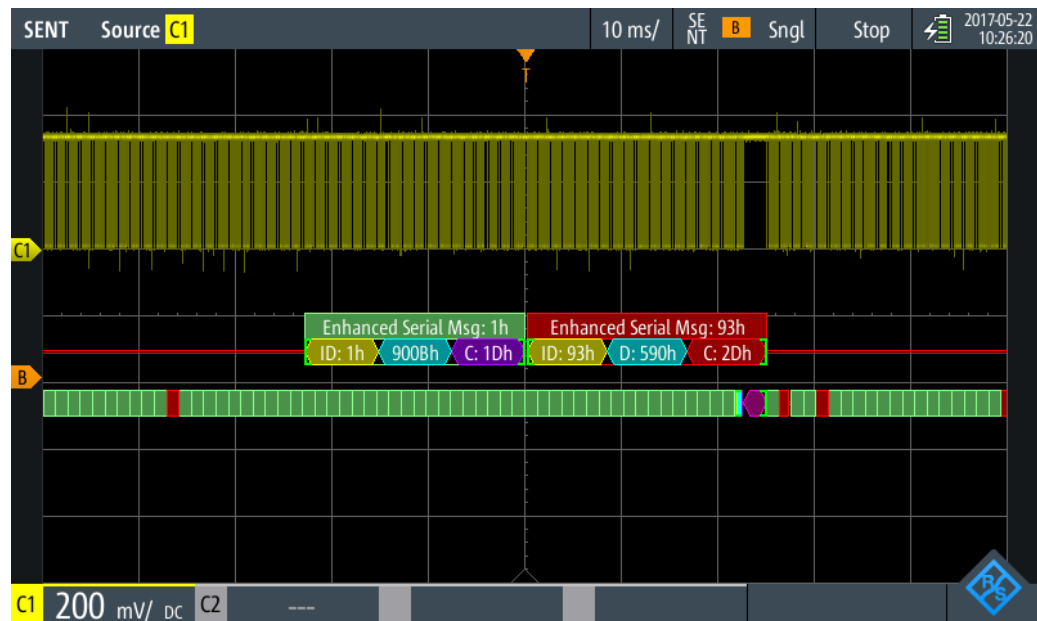

Figure 9-43: Comb display of a decoded SENT signal, triggered on slow ID

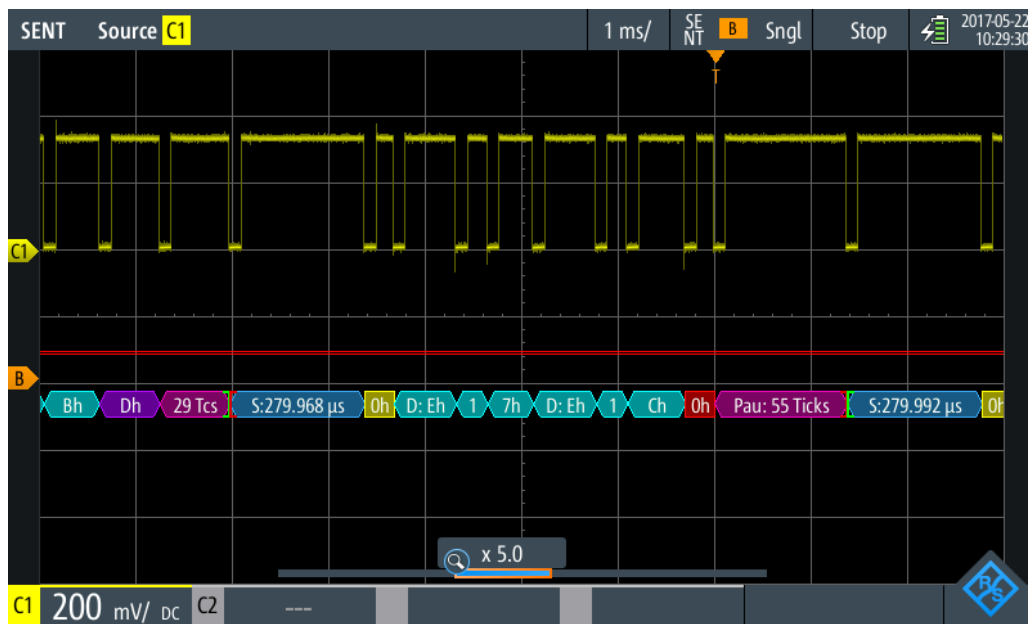

Figure 9-44: Comb display of a decoded SENT signal, triggered on fast CRC

The color-coding of the various protocol sections and errors simplifies the interpretation of the visual display.

Table 9-12: Color codes of decoded SENT signals

Color, display element	Description
Green brackets [...]	Start and end of frame
Green frame header	Data frame. Text indicates the frame ID (hex).
Magenta comb	Pause pulse field
Blue comb	Sync/ calibration field
Yellow comb	Identifier
Violet comb	CRC checksum
Cyan comb	Data bytes
Red	Error in frame, CRC error, nibble length error, pulse period error, frame length error, incomplete frame

In "Protocol" mode, decoded data is shown in tabular form. The fast channel messages and the slow channel messages are shown in separate tables.

Fast Frame #	Fast Frame Start	Status [bin]	Values 4 bit [hex]	CRC [hex]	State
1	-5.001 ms		D	4	Incomplete
2	-2.385 ms	0011	3 F B C C C	B	Ok
3	-1.105 ms	0011	3 F A C D		Nibble Len. Err
4	+175 µs	0000	2 5 4 4 A 4	F	Ok
5	+1.455 ms	0000	0 C 6 C 1 5	4	Ok
6	+2.735 ms	0000	F 3 E F 1 6	4	CRC Error
7	+4.015 ms	0000	D C F 4 8		Incomplete

Figure 9-45: Table display of a decoded SENT signal, triggered on pulse period error

Table 9-13: Content of the protocol table for decoded SENT signal

Column	Description
#	Frame index
Frame start	Time of frame start
Status	Status value
ID [hex]	Identifier value, hexadecimal value
Values 8 bit [format]	Values of data bytes. The data format is selected in the "Bus" menu.
CRC [bin]	CRC sequence value
State	Overall state of the frame. "Incomplete" indicates that the frame is not contained completely in the acquisition. Change the time scale, or move the reference point to the left to get a longer acquisition.

Remote control commands are described in [Chapter 15.11.7.3, "SENT Decode Results"](#), on page 485.

10 Logic Analyzer (R&S RTH-B1 MSO)

The Mixed Signal Option R&S RTH-B1 adds logic analyzer functions to the classical oscilloscope functions. Using the logic analyzer, you can analyze and debug embedded systems with mixed-signal designs that use analog signals and time-correlated digital signals simultaneously. The option provides a logic probe with 8 logic channels. The instrument ensures that analog and digital waveforms are time-aligned and synchronized so that critical timing interactions between analog and digital signals can be displayed and tested.

Each logic channel can be displayed on the screen and used as trigger source.

- ▶ To activate the logic analyzer, shortly press the [LOGIC] key.
To disable, press [LOGIC] again.
- ▶ To configure logic channels, press and hold the [LOGIC] key until the "Logic" menu opens.

To scale and move the logic channels vertically:

1. If the logic channels are not focused, press the [LOGIC] key to set the focus.
2. Press the vertical [RANGE] and [POS] keys.

10.1 Logic Analyzer Settings

Access: "Logic" menu



Logic Channels

Enables or disables the logic channels.

Remote command:

[LOGic:STATE](#) on page 491

Visible

By default, all 8 logic channels are displayed. Disable the logic channels that you do not need for analysis.

Couple Thresh.

Couples the threshold and hysteresis settings for the logic channels.

If enabled, all logic channels use the same threshold and hysteresis settings.

If disabled, 2 channel groups are available, which can use different threshold and hysteresis settings: D0 - D3, and D4 - D7.

Remote command:

[LOGic:THCoupling](#) on page 491

Threshold

Sets the threshold value for the selected channel group, or for all logic channels. For each acquired sample, the instrument compares the input voltage with the threshold value. If the input voltage is above the threshold, the signal state "1" is stored. Otherwise, the signal state "0" is stored if the input voltage is below the threshold.

You can set the digital threshold in several ways:

- The same threshold and hysteresis are used for all logic channels: Enable "Threshold" and set the values for channels D0 - D3, and D4 - D7.
- Different thresholds and hysteresis are used for individual channel groups: Disable "Threshold" and set the threshold and hysteresis for each group.

You can select the threshold voltages for various types of integrated circuits in the list, or set a user-defined value.

"TTL"	1.4 V
"ECL"	-1.3 V
"CMOS"	2.5 V
"GND"	0 V (for CAN channels, requires option R&S RTH-K3)
"CAN"	2 V (for CAN channels, requires option R&S RTH-K3)
"7 V Supply"	7 V (for LIN channels, requires option R&S RTH-K3)
"12 V Supply"	12 V (for LIN channels, requires option R&S RTH-K3)
"18 V Supply"	18 V (for LIN channels, requires option R&S RTH-K3)

Remote command:

[LOGic:GROup<m>:TECHnology](#) on page 492

[LOGic:GROup<m>:USER](#) on page 492

Hysteresis

Hysteresis avoids the change of signal states due to noise oscillation around the threshold level. Set a small hysteresis for clean signals, and large hysteresis for noisy signals.

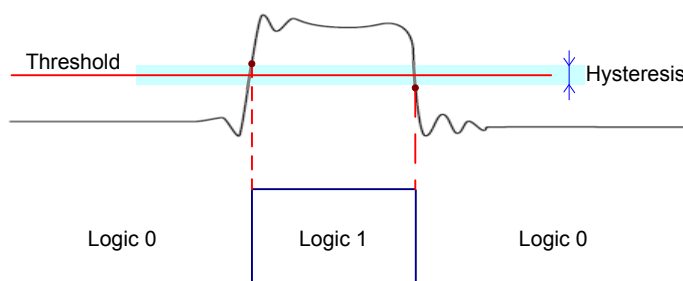

Remote command:

[LOGic:GROup<m>:HYSTeresis](#) on page 493

Deskew

Enables deskewing.

Deskew compensates delays that are known from the circuit specifics or caused by the different length of cables. The skew between the probe boxes of the digital channels and the probe connectors of the analog channels is automatically aligned by the instrument.

Select Channel, Deskew

You can set the deskew for all channels of a logic probe at once, or for each logic channel separately.

Select the channel and enter the deskew value in "Deskew".

Remote command:

`LOGic:CHANnel<m>:DESKew` on page 493

Set all Deskews to Zero

Resets all deskew values to zero.

10.2 Triggering on Logic Channels

Each digital channel can be used as trigger source. Using the pattern trigger, you can trigger on logical combinations of analog and digital channels. Additionally, you can define a trigger holdoff time.

If you trigger on logic channels, the threshold is used as trigger level. The "Trigger Level" setting is not available.

The following trigger types are available if the trigger source is a logic channel:

- Edge
- Glitch
- Width
- Pattern: the pattern can use all active logic channels
- State: the pattern can use all active logic channels
- Data2Clock: only the clock can be a logic channel.
- Serial pattern: clock and data source can be logic channels.
- Timeout
- Interval
- Window

All trigger types except for edge, glitch and width require option R&S RTH-K19.

For analysis of serial protocols, you configure the protocol using logic channels as sources, and trigger on trigger type "Bus". For details, see the chapter describing the relevant bus.

10.3 Analyzing Logic Channels

The main analysis tools for logic channels are serial protocol analysis ([BUS]), and the pattern and state triggers.

Furthermore, you can zoom into the display ([ZOOM]).

To measure logic channels, you can use automatic and cursor measurements as usual. The following measurement types are available:

- Period
- Frequency

- Positive and negative pulse width
- Positive and negative duty cycle
- Delay (only automatic measurements)
- Phase (only automatic measurements)
- Mean
- Positive and negative pulse count
- Rising and falling edge count

See also [Chapter 4.2, "Automatic Measurements"](#), on page 81 and [Chapter 4.3, "Cursor Measurements"](#), on page 88.

You can also export the waveform data: [FILE] > "Waveforms"

11 Frequency Counter (R&S RTH-K33)

The frequency counter is only available if the counter mode option R&S RTH-K33 is installed.

The R&S RTH measures frequencies in various ways:

- You can use the automatic measurement function in scope mode.
- The FFT analysis mode converts the data into the frequency domain, providing a spectrum of the input signal (see [Chapter 6.1, "FFT Mode"](#), on page 110). During FFT analysis, the frequency resolution is restricted by the selected data acquisition settings (channel bandwidth, frequency span, and time scale).
- To determine the frequency of an input signal accurately without changing the data acquisition settings, the R&S RTH is equipped with a signal counter function. The signal counter counts the zero crossings of the input signal (thus the term *signal counter*) and derives the precise frequency value.

The R&S RTH counter mode option provides two separate counters. One counter can be used as a reference for the second one, so that the deviation from the reference value can be compensated for and the frequency becomes more accurate. Alternatively, both counters can measure different input signals.

Using the data logger, you can also store a series of frequency values measured by the counter over time.

11.1 Accessing the Counter Mode

1. Press the [MODE] key.



2. Select "Counter".

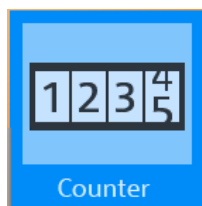

11.2 Display and Control

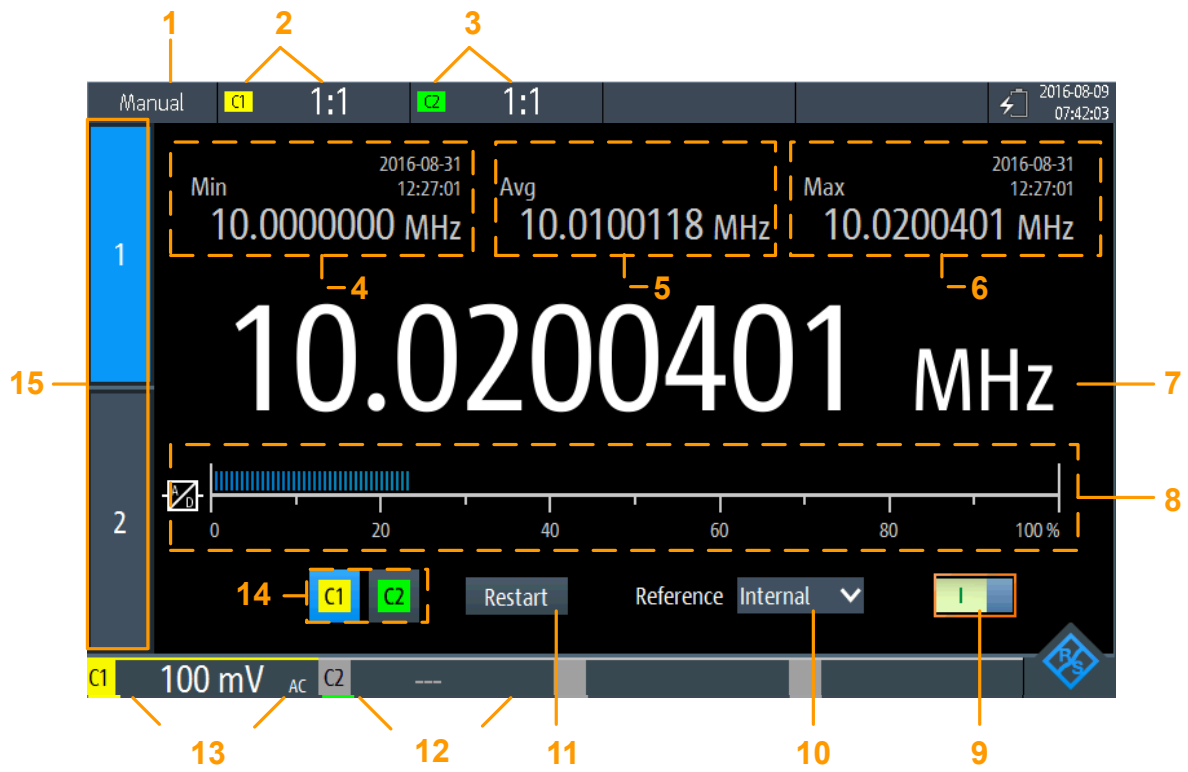

Figure 11-1: Display for basic counter

- 1 = Measurement state. "Manual": running measurement with manual range; "Hold": stopped measurement
- 2 = Vertical settings for channel 1 (incl. "Probe Setting")
- 3 = Vertical settings for channel 2 (incl. "Probe Setting")
- 4 = Minimum frequency and timestamp
- 5 = Average frequency
- 6 = Maximum frequency and timestamp
- 7 = Currently measured frequency
- 8 = Bargraph indicating the load level of the A/D converter for the selected measurement range; for values $\geq 100\%$, an overload warning is displayed; for optimal results the load level should be above 20 %;
- 9 = Counter on/off switch
- 10 = Used reference (Internal or Counter 2)
- 11 = Restarts the measurement and resets all values
- 12+13 = Measurement ranges of active channels
- 14 = Channel input selection
- 15 = Counter selection

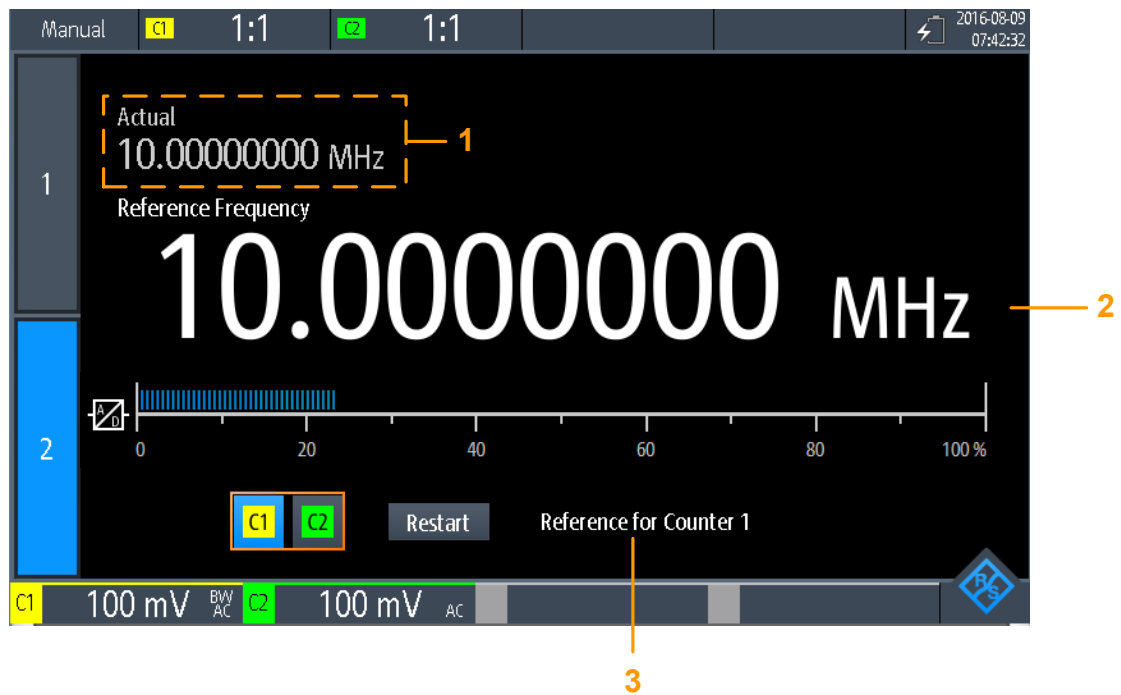

Figure 11-2: Display for reference counter

- 1 = Measured frequency at basic counter
- 2 = Measured frequency at reference counter (used as a reference frequency for basic counter)
- 3 = Counter usage

If both counters are active, you can display both measured counter frequencies at the same time. When both counter results are displayed simultaneously, only the measured frequencies and the load bargraphs are displayed. Statistics or additional settings are not available.

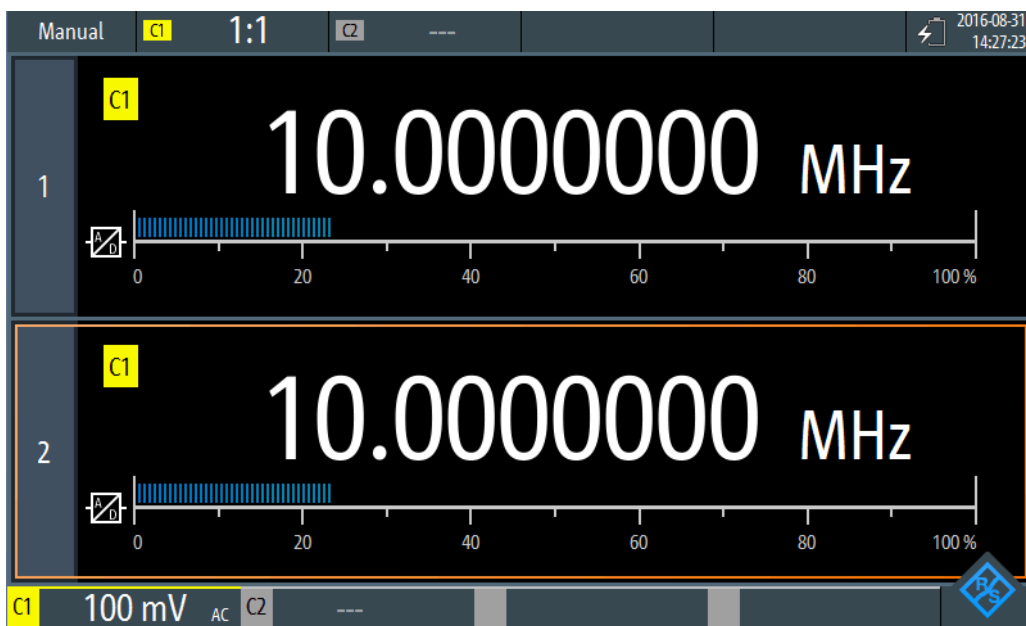

Figure 11-3: Display for two counters simultaneously

1. To display both counters, tap the currently highlighted counter selection tab.
2. To return to a single counter display, tap one of the counter selection tabs.

In counter mode, the keys behave slightly different from scope mode:

- The vertical [RANGE] and [POS] keys adjust the measurement range.
- The [MEAS] key opens the "Counter" menu.
- The following keys work as usual: [FILE], [Settings], [Camera], [PRESET], [MODE], [BACK].
- All other keys do not work.

Measurement Mode.....	262
Current Result.....	263
Minimum.....	263
Maximum.....	263
Average.....	263

Measurement Mode

Tap the setting to switch between continuous measurement ("MANUAL") and a single measurement ("HOLD"). This has the same effect as selecting the [TRIGGER RUN STOP] key.

For a single measurement, the continuous measurement is stopped and the most recent value is displayed.

During continuous measurements, the most recent value is preserved and displayed, while the oldest values are overwritten.

Note: The statistical values are not reset when the measurement is stopped. They are only reset after you manually select [Restart](#).

Remote command:

[COUNTER<m>:SENSe:TRIGger:MODE](#) on page 417

[COUNTER<m>:INITiate](#) on page 415

[COUNTER<m>:ABORt](#) on page 412

Current Result

The currently measured counter frequency.

Remote command:

[COUNTER<m>:READ?](#) on page 416

[COUNTER<m>:FETCh?](#) on page 414

[COUNTER<m>:MEASure:FREQuency?](#) on page 415

Minimum

The minimum of all measured counter frequencies since statistics were last restarted.

Remote command:

[COUNTER<m>:CALCulate:AVERage:MINimum?](#) on page 413

[COUNTER<m>:CALCulate:AVERage:ALL?](#) on page 412

Maximum

The maximum of all measured counter frequencies since statistics were last restarted.

Remote command:

[COUNTER<m>:CALCulate:AVERage:MAXimum?](#) on page 413

[COUNTER<m>:CALCulate:AVERage:ALL?](#) on page 412

Average

The average of all measured counter frequencies since statistics were last restarted.

Remote command:

[COUNTER<m>:CALCulate:AVERage:AVERage?](#) on page 412

[COUNTER<m>:CALCulate:AVERage:ALL?](#) on page 412

11.3 Performing a Counter Measurement

To perform a basic counter measurement without a reference

1. Before you can perform a counter measurement, adjust the waveforms by editing the vertical, horizontal, trigger and acquisition settings.

For details see:

- [Chapter 3.2, "Vertical Setup"](#), on page 41
- [Chapter 3.3, "Horizontal Setup"](#), on page 46
- [Chapter 3.6, "Trigger"](#), on page 52
- [Chapter 3.4, "Acquisition Control"](#), on page 48

2. To adjust the instrument settings to the current input signal automatically, press [AUTOSET].

3. Select the "Counter" mode.
4. Select the channel to be used as input for the counter.
5. Activate the first (basic) counter.
A continuous measurement starts and the signal counter indicates the measured frequency. With each new measurement, the statistical values are updated.
6. To start and stop a counter measurement, press the [RUN STOP] key.



7. Optionally, activate a second basic counter.
 - a) Select the second counter tab.
 - b) Select the input channel for the counter.
 - c) Activate the counter.
 - d) Tap the second counter tab again to display both counter results simultaneously.

To perform a counter measurement with a second counter as a reference

1. Before you can perform a counter measurement, adjust the waveforms by editing the vertical, horizontal, trigger and acquisition settings.
For details see:
 - [Chapter 3.2, "Vertical Setup"](#), on page 41
 - [Chapter 3.3, "Horizontal Setup"](#), on page 46
 - [Chapter 3.6, "Trigger"](#), on page 52
 - [Chapter 3.4, "Acquisition Control"](#), on page 48
2. To adjust the instrument settings to the current input signal automatically, press [AUTOSET].
3. Select the "Counter" mode.
4. Select the "Counter" menu.
5. Select the channel to be used as input for the basic counter.
6. Select "Reference": "Counter 2".
7. Define the (nominal) "Reference Frequency" to be assigned to the value measured on counter 2.
8. Activate the first (basic) counter.
A continuous measurement starts and the signal counter indicates the measured frequency. With each new measurement, the statistical values are updated. The second counter is also activated automatically.
9. Tap "Select Counter": "2".
10. Select the input channel for the reference counter 2. Make sure the selected channel provides a precise signal with the specified reference frequency.

If the measured reference frequency deviates extremely from the specified frequency, a warning is displayed.

11. Select "Restart" to reset the statistical values and start a new measurement with the reference frequency.

The deviation of the nominal frequency to the measured frequency is internally removed from the measured frequency. The display indicates the accurate frequency of the input signal.

12. Optionally, tap the second counter tab again to display both counter results simultaneously.
13. To start and stop a counter measurement, press the [RUN STOP] key.



11.4 Counter Settings

Access: "Counter" menu



Additional settings for vertical scaling are available for Counter mode and directly accessible via the "Counter" menu. For a description see:

- "[Channel Index](#)" on page 42
- "[Probe Setting](#)" on page 43
- "[Bandwidth](#)" on page 43

Furthermore, the logger function can be used to store counter values, see [Chapter 8, "Data Logging"](#), on page 159.

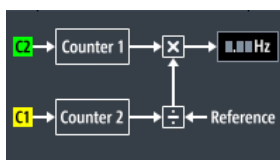
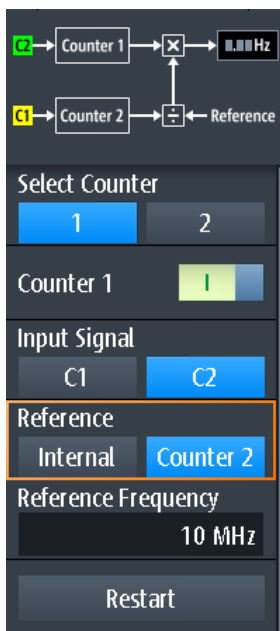

The diagram at the top of the "Counter" menu indicates how the data will be processed using the current settings.

Select Counter.....	266
Counter 1 / 2 State.....	266
Input Signal.....	266
Reference.....	267
Restart.....	267

Select Counter

Selects the counter to be configured.

Remote command:

Suffix for COUNTER, see [Chapter 15.9, "Counter Mode \(R&S RTH-K33\)"](#), on page 411

Counter 1 / 2 State

Activates or deactivates the basic counter.

Remote command:

COUNTER<m>:SENSe:STATe on page 417

Input Signal

Selects one of the channels as the input for the counter measurement.

Remote command:

COUNTER<m>:SENSe:SOURce on page 417

Reference

Selects the reference to be used for the counter.

"Counter 1 / 2" The measured value of the other counter is used as a reference. Specify the nominal "Reference Frequency" for counter 2. The deviation of the nominal frequency to the measured reference frequency is internally removed from the measured frequency of counter 1.

"Internal" An internal reference is used to determine the counter frequency.

Remote command:

[COUNter<m>:SENSe:REFerence:STATe](#) on page 416

[COUNter<m>:SENSe:REFerence:VALue](#) on page 417

Restart

Resets all statistical values and starts a new counter measurement.

Remote command:

[COUNter<m>:CALCulate:AVERage:CLEar](#) on page 412

[COUNter<m>:INITiate](#) on page 415

12 Documenting Results

- ▶ To access export and data functions, press the [FILE] key.

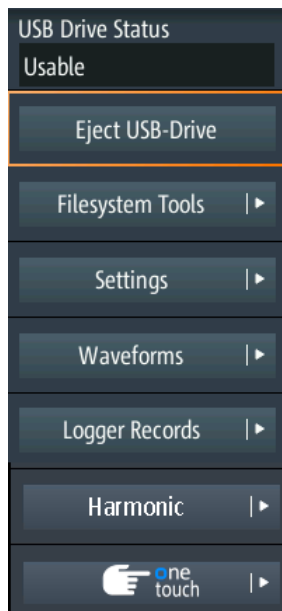

- ▶ To configure screenshots, press and hold the  key until the menu opens.

The R&S RTH can store various data to files for further analysis and reporting:

- [Instrument Settings](#)
- [Waveforms](#)
- [Export of Logger Records](#)
- [Screenshots](#)
- Harmonic results (see [Chapter 6.3, "Harmonics Measurement \(Option R&S RTH-K34\)"](#), on page 134).

You can also combine these data and save it to file by pressing the  key: [Quick Save with OneTouch](#).

To check the storage devices and manage the data files, the [Filesystem Tools](#) menu provides various functions.

12.1 Using USB Flash Drive

You can connect a USB flash drive on the right side of the instrument. If a USB flash drive is connected, all screenshots and result data are written to this external device by default. Instrument settings are saved on the instrument, but you can store them to the USB flash drive as well.

1. To check the status of the USB flash drive, press the [FILE] key.
The connection status is shown on the top of the menu.



2. To remove the USB flash drive from the instrument, tap "Eject USB Drive" in the "File" menu.
3. To check the file system on the USB flash drive for errors, tap "Filesystem Tools" > "Check USB Drive".

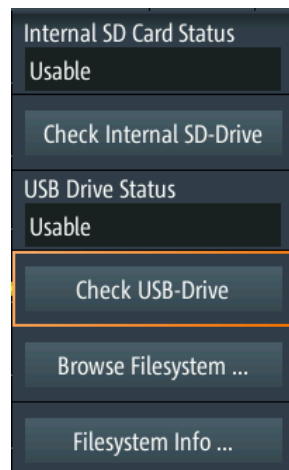

12.2 Filesystem Tools

Access: [FILE] > "Filesystem Tools"

The "Filesystem Tools" help you to check the storage devices and manage the data files.

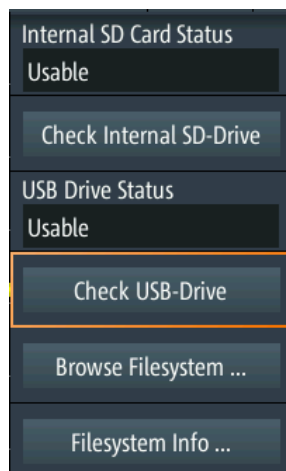
**Internal SD Card Status**

Shows the status of the internal SD card.

Check Internal SD Drive

Checks the file system on the SD card for errors.

USB Drive Status

Shows the status of the USB flash drive: "Usable", "Safe to remove", or "Not available".

See also: [Chapter 12.1, "Using USB Flash Drive"](#), on page 268.

Check USB Drive

Checks the file system on the USB flash drive for errors.

See [Chapter 12.1, "Using USB Flash Drive"](#), on page 268.

Browse Filesystem

Opens a file explorer, where you can check the files on the SD card and on the USB flash drive. You can also copy, delete and rename files, and create folders. Some options help to navigate and select files.

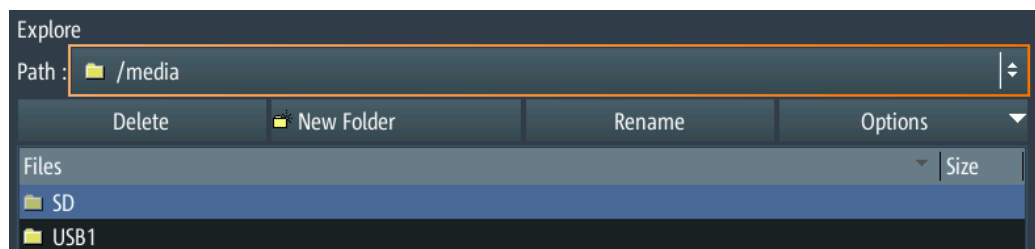
**Filesystem Info**

Shows the overall and free space that is available on the connected storage devices.

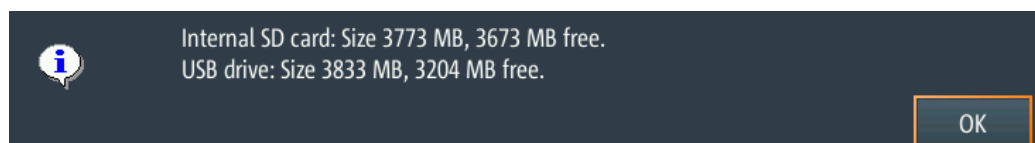

12.3 Instrument Settings

To repeat measurements or tests at different times or perform similar measurements with different test data, you can save the used configuration settings for later use. Furthermore, it can be helpful to refer to the configuration settings of a particular measurement when analyzing the results. Therefore, you can easily save the complete measurement configuration including the display settings.

The R&S RTH provides two ways to store the measurement configuration:

- Save as fast setting
- Save as saveset

12.3.1 Using Fast Settings

The R&S RTH has 8 slots to save and load often used configuration settings very quickly.

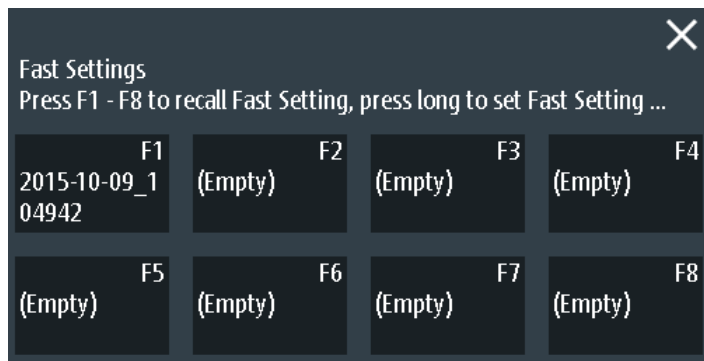

To save the current setting as fast setting

1. Press the [SHIFT] key.
2. Tap and hold one of the storage slots F1...F8.
The online keyboard opens.
3. Type the settings name and tap [+].
The configuration settings are saved to the slot.

To load a fast setting

1. Press the [SHIFT] key.
2. Tap the storage slot that holds the required configuration.
The settings are loaded.

Alternatively, you can save and load fast settings in the "File" menu: [FILE] > "Settings" > "Fast Settings".

12.3.2 Saving and Loading Savesets

You can save and reload an unlimited number of configuration setups. By default, the settings are stored on the microSD card in the following directory:

```
media/SD/Rohde-Schwarz/RTH/SaveSets
```

The storage location can be changed. The file format is XML.

To save the current settings in a saveset

1. Press the [FILE] key.
2. Tap "Settings".
3. The current storage location is shown in "Setting Directory".
 - To store the file under a default name in the specified directory, tap "Save Setting".
 - To store the file in another directory and/or with a user-defined filename, tap "Save Setting As". Select the path, directory, and enter the filename.

To load and display a saveset

1. Press the [FILE] key.
2. Tap "Settings".
3. The current storage location is shown in "Setting Directory".
 - To load a file from the specified directory, tap "Load Setting".
 - To load a file from another directory, tap "Setting Directory" and change the directory. Tap "Load Setting".
4. Select the file to be loaded.

Description of settings



Load Setting

Opens the specified directory. Tap the file to be loaded.

Save Setting

Saves the settings to the specified directory with a default filename. The filename pattern is: <filename base>_<date>_<time>.xml.

Save Setting As

Opens a file selection dialog. Navigate to the target directory and enter the filename. Tap "Save" to store the file.

Setting Directory

Sets the directory to which the settings are stored with the "Save Setting" function.

Filename Base

Defines the first part of the filename. The complete filename pattern is:
<filename base>_<date>_<time>.xml.

12.4 Waveforms

Analog channel and math waveforms can be saved in several ways:

- As reference waveforms for later use on the instrument: "Ref" menu. See: [Chapter 4.5, "Reference Waveforms"](#), on page 94
- In CSV file on a USB flash drive or internal SD card for further analysis using other applications: [FILE] > "Waveforms". This way is described in the current chapter.

If you want to save many waveforms, you can assign the function to the  key. See: [Chapter 12.6, "Quick Save with OneTouch"](#), on page 280.

12.4.1 Exporting Waveforms to File

The waveform export provides the following possibilities:

- Store either one waveform or all active waveforms.
- Include time values.
- Option R&S RTH-K15: Save history data.
- Option R&S RTH-B1: Save logic channels.

If a USB flash drive is attached, the file is stored there. Otherwise, the file is stored in the `Export` folder on the microSD card.

1. Activate the waveforms that you want to export.
2. Press the [FILE] key.
3. Select "Waveforms".
4. Select the waveforms for export:

- a) Tap "Select Waveform".
- b)
 - Select one waveform for export.
 - Or select all active waveforms.
5. Select the "File Format".
6. Check the "Directory", the "Filename Base", and the "CSV Column Delimiter". Adjust if necessary.
7. If you need time information for analysis, enable "Store with Time".
8. If you want to save history data, enable "Save History".
9. Tap "Save Waveform".

All export settings are described in [Chapter 12.4.2, "Waveform Export Settings"](#), on page 274.

12.4.2 Waveform Export Settings

Access: [FILE] > "Waveforms"



Select Waveform

Select the waveform to be exported. You can export:

- A single analog channel or math waveform
- All active digital channels
- All active waveforms at once

Remote command:

[EXPort:WAVeform:SOURce](#) on page 495

[EXPort:WAVeform:MULTichannel](#) on page 496

Save History

This function is only available if option R&S RTH-K15 is installed. It includes the waveform history in the data export. If acquisition is running, enabling "Save History" stops the acquisition. History data is always saved in "Compressed CSV" files.

For details, see [Chapter 4.7.4, "Exporting History Data"](#), on page 103.

File Format

Selects the format of the export file.

"CSV"	Comma-separated values (CSV) text file, the waveform is stored in a table. The columns are separated by commas or another delimiter. For each sample, one line is written. Values are listed in scientific notation. You can convert the comma-separated text to columns.
"Compressed CSV"	ZIP file that contains one or more CSV files. This format reduces the file size.

Remote command:

[EXPort:WAVeform:NAME](#) on page 495

Save Waveform / Save Waveform As

Save the waveform data. The functions are available if the instrument is in a waveform mode ("Scope", "XY", "Mask", "Roll", "Mask").

"Save Waveform" Saves the file in the defined "Directory" using the autonaming pattern.

"Save Waveform As" Opens a file explorer where you can select the directory and enter the filename.

Remote command:

[EXPort:WAVeform:SAVE](#) on page 497

Directory

Defines the directory where the waveform files are stored. If a USB flash drive is connected, the instrument stores the data to this external device by default.

Remote command:

[EXPort:WAVeform:NAME](#) on page 495

Filename Base

Defines the first part of the autonaming pattern. The complete filename pattern is:

```
<filename base>_<date>_<acq time>_<index>.csv|zip.
```

Remote command:

[EXPort:WAVeform:NAME](#) on page 495

Store with Time

Includes horizontal values in the export data (time values).

Remote command:

[EXPort:WAVeform:INCXvalues](#) on page 496

CSV Column Delimiter

Selects the column delimiter for CSV files. You need to know the delimiter when you convert the CSV text to columns in a spreadsheet.

12.4.3 Waveform Export Files

Waveform data is stored in CSV or compressed CSV format.

The filenames are built using the filename pattern:

<filename base>_<date>_<timestamp>.csv|zip.

A CSV file is a comma-separated values (CSV) text file, the waveform is stored in a table. The columns are separated by commas or another delimiter. For each sample, one line is written. Values are listed in scientific notation. You can convert the comma-separated text to columns.

If the history option R&S RTH-K15 is installed, you can also save the history waveforms. For details, see [Chapter 4.7.4, "Exporting History Data"](#), on page 103.

12.4.3.1 Content of Waveform Files

The first lines of the file contain header data, for example, time scale, vertical scale, vertical and horizontal positions. Header data is required to interpret the waveform data, and to analyze the data values of the data file.

Model	RTH1004				
SerialNumber	900116				
Firmware Version	'1.70.2.47_Beta'				
Acquisition Time Stamp	2018-08-07 14:44:15.981047121	2018-08-07 14:44:15.981047121	2018-08-07	Acquisition Time Stamp	2018-08-07 14:44:15.981047121
Waveform Type	ANALOG			Waveform Type	ANALOG
Acquisition Mode	SAMPLE				
Horizontal Unit	s			Horizontal Unit	s
Horizontal Scale	1,00E-05			Horizontal Scale	1,00E-05
Horizontal Position	0			Horizontal Position	0
Reference Point	50%			Reference Point	50%
Sample Interval	4,00E-10			Sample Interval	4,00E-10
Record Length	250000			Record Length	250000
Probe Setting	'10:1'	'10:1'			
Vertical Unit	V	V		Vertical Unit	V/div
Vertical Scale	5			Vertical Scale	
Vertical Position	2				
Vertical Offset	0				
History Index	0			0 History Index	0
History Time Stamp	0.000000000000	0.000000000000	0.000000000000	History Time Stamp	0.000000000000
	CH1	CH2			MATH<-C1>
	32.549	317.647			-321.569
	309.804	364.706			-305.882
	356.863	32.549			-352.941
	32.549	34.902			-321.569
	317.647	333.333			-313.725
	309.804	356.863			-305.882
	32.549	341.176			-321.569
	309.804	372.549			-305.882
	317.647	341.176			-313.725

Figure 12-1: Waveform data file with voltage values, text converted to columns

By default, only Y-values are stored. You can include the time values in the file.

Model	RTH1004				
SerialNumber	900116				
Firmware Version	'1.70.2.47_Beta'				
Acquisition Time Stamp	2018-08-07 14:52:16.900379887	2018-08-07 14:52:16.900379887	2018-08-07 14:52:16.900379887	Acquisition Time Stamp	2018-08-07 14:52:16.900379887
Waveform Type	ANALOG			Waveform Type	ANALOG
Acquisition Mode	SAMPLE				
Horizontal Unit	s			Horizontal Unit	s
Horizontal Scale	5,00E-06			Horizontal Scale	5,00E-06
Horizontal Position	0			Horizontal Position	0
Reference Point	50%			Reference Point	50%
Sample Interval	4,00E-10			Sample Interval	4,00E-10
Record Length	125000			Record Length	125000
Probe Setting	'10:1'		'10:1'		
Vertical Unit	V		V	Vertical Unit	V/div
Vertical Scale	5		5	Vertical Scale	
Vertical Position	2		-2		
Vertical Offset	0		0		
History Index	0		0	0 History Index	0
History Time Stamp	0.000000000000		0.000000000000	0.0000000 History Time Stamp	0.000000000000
TIME	CH1	CH2		TIME	MATH<-C1>
-2,5e-05	32.549	364.706		-2,5e-05	-32.549
-2,50E+00	341.176	341.176		-2,50E+00	-341.176
-2,50E+00	317.647	356.863		-2,50E+00	-317.647
-2,50E+00	341.176	333.333		-2,50E+00	-341.176
-2,50E+00	317.647	372.549		-2,50E+00	-317.647
-2,50E-01	32.549	34.902		-2,50E-01	-32.549

Figure 12-2: Waveform data file with voltage and time values, text converted to columns

If the acquisition mode is envelope or peak detect, two values (minimum and maximum) are written for each sample. The file contains two columns for each active analog channel.

Model	RTH1004			
SerialNumber	900116			
Firmware Version	'1.70.2.47_Beta'			
Acquisition Time Stamp	2018-08-07 14:59:29.698	2018-08-07 14:59:29.698	2018-08-07 14:59:29.698	2018-08-07 14:59:29.698996237
Waveform Type	ANALOG			
Acquisition Mode	ENVELOPE			
Horizontal Unit	s			
Horizontal Scale	1,00E-06			
Horizontal Position	0			
Reference Point	50%			
Sample Interval	4,00E-10			
Record Length	25000			
Probe Setting	'10:1'	'10:1'	'10:1'	'10:1'
Vertical Unit	V	V	V	V
Vertical Scale	5	5	5	5
Vertical Position	2	2	-2	-2
Vertical Offset	0	0	0	0
History Index	0	0	0	0
History Time Stamp	0.000000000000	0.000000000000	0.000000000000	0.000000000000
	CH1 MAX	CH1 MIN	CH2 MAX	CH2 MIN
	34.902	-0.27451	356.863	-0.117647
	341.176	-0.117647	388.235	-0.0392157
	34.902	-0.117647	34.902	-0.117647
	356.863	-0.431373	380.392	-0.117647
	34.902	-0.27451	34.902	-0.0392157
	341.176	-0.27451	372.549	-0.117647
	34.902	-0.196078	333.333	-0.117647
	32.549	-0.27451	388.235	-0.117647
	34.902	-0.196078	356.863	-0.117647

Figure 12-3: Waveform data file with two voltage values per sample, acquisition mode is envelope

12.4.3.2 Header Data

The header lines contain the following properties:

Value	Description
Acquisition Time Stamp	Time of the waveform acquisition
Waveform Type	ANALOG for analog channel signals and math waveforms, DIGITAL for logic signals
Acquisition Mode	Acquisition mode that has been used: sample, peak detect, high resolution, average, envelope. If peak detect or envelope is set, two values (minimum and maximum) are written for each sample. Only for analog channels.
Horizontal Unit	s, second
Horizontal Scale	In s/div
Horizontal Position	Distance of the trigger point from the reference point.
Reference Point	Position in the diagram: left = 10%, middle = 50%, and right = 90%
Sample Interval	Time between two samples

Value	Description
Record Length	Number of samples, corresponds to the number of data lines in the file
Probe Setting	Attenuation factor of the connected probe, only for analog channels.
Vertical Unit	V or A
Vertical Scale	In V/div or A/div, only for analog channels and math waveforms.
Vertical Position	In divisions, only for analog channels
Vertical Offset	In V or A, only for analog channels
Threshold	Only for digital channels
History Index	Only for history export, see Chapter 4.7.4, "Exporting History Data" , on page 103
History Time Stamp	

12.4.3.3 Converting CSV to Excel Files

If you open an exported CSV file in Excel or another spreadsheet, all data is written in one column. The value delimiter is usually a comma, but you can select another delimiter in the export settings. As an example, the following procedure describes text conversion to columns in Excel. Other spreadsheet applications provide similar features. Make sure to select the correct text delimiter, decimal separator and thousands separator.

1. Open the CSV file in Excel.
2. Click the column header "A" to select all data.
3. On the "Data" ribbon, click "Text to Columns".
4. Select the data type "Delimited".
Click "Next".
5. Select the delimiter that you have used in the export file (usually a comma).
Click "Next".
6. Click "Advanced".
7. Select the point as decimal separator and the comma as thousands separator.

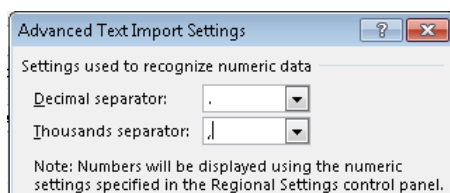

8. Click "Finish".

12.5 Logger Records

See [Chapter 8.6, "Export of Logger Records"](#), on page 170.

12.6 Quick Save with OneTouch

The  key initiates one or more assigned saving actions. By default, the key saves a screenshot.

If OneTouch is enabled, you can assign the following actions to the  key:

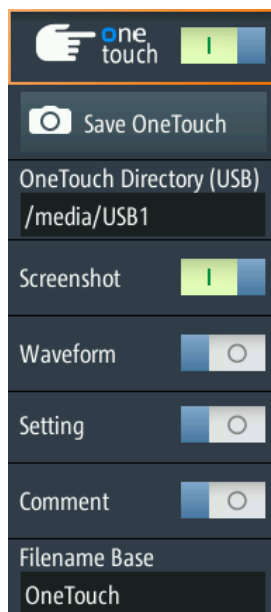

- Save a screenshot
- Save waveforms
- Save harmonic measurement results (requires option R&S RTH-K34)
- Save spectrum analysis results (requires option R&S RTH-K18)
- Save settings
- Add a comment to the saved file.

Access: [FILE] > "one touch", or "Screenshot" menu > "one touch"



One touch

Switches the function of the  key:

- If OneTouch is disabled, the  key saves a screenshot of the current display.
- If OneTouch is enabled, the  key can also save waveform data and settings in addition to the screenshot.

Save OneTouch

Saves the selected data to a ZIP file.

OneTouch Directory

Defines the directory where the OneTouch ZIP files are stored. If a USB flash drive is connected, the instrument stores the data to this external device by default.

Screenshot, Waveform, Setting

Select the data that you want to include in the OneTouch file.

Comment

If enabled, you can enter a comment when you save a OneTouch file. The comment is written to a text file, which is included in the ZIP file. Furthermore, the first 10 characters of the comment are added to the ZIP filename.

Filename Base

Defines the first part of the filename. The complete filename pattern is:

```
<filename base>_<current time> <comment10ch>.zip.
```

12.7 Screenshots

You can create and save screenshots of the current display of your waveforms and measurement results. If a USB flash device is connected to the R&S RTH, the instrument saves the screenshot to the USB flash drive. Otherwise, the screenshots are saved on the microSD card.



To save the current display in a screenshot:

1. Press the FILE key.
2. Disable "One touch".
3. Press the  key each time when you want to save a screenshot.

To configure the screenshots:

- ▶ Press and hold the  key until the menu opens, or open the "Screenshot" menu using the "Menu" button.

You can also view all saved screenshots directly on the instrument.

12.7.1 Screenshot Settings

Access: "Screenshot" menu

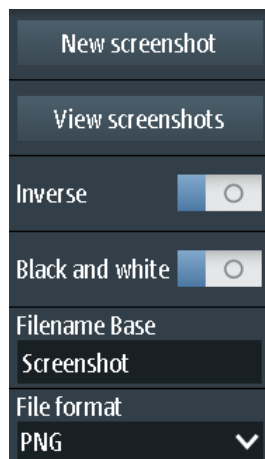
**New screenshot**

Saves the current display in a new screenshot.

Remote command:

[HCOPY:IMMEDIATE](#) on page 500

View screenshots

Displays the last saved screenshot. You can browse all screenshots that are saved.

Inverse

Inverts the colors of the output, i.e. a dark waveform is printed on a white background.

Remote command:

[HCOPY:INVERSE](#) on page 500

Black and White

Creates a black and white screenshot.

Remote command:

[HCOPY:COLOR](#) on page 500

Filename base

Defines the prefix of the file name. By default, the filename has the prefix "Screenshot_".

Remote command:

[MMEMORY:NAME](#) on page 500

File format

Defines the format of the screenshot file. The following formats are available:

- PNG: Portable Network Graphics is a graphic format with lossless data compression.
- JPG: compressed file format, compression according to to JPEG standard
- BMP: BitMaP is an uncompressed format, files are large and saving might take some time.
- TIFF: Tagged Image File Format, often used in publishing companies and print processing.

Remote command:

[HCOpy: LANGuage](#) on page 500

13 General Instrument Setup

The general instrument settings are available in all operating modes.

13.1 Resetting the Instrument

Reset is helpful if the instrument is in undefined condition and cannot be operated.

- ▶ To switch off the instrument and reset the hardware, press the  power key for 5 seconds.
- ▶ To restore the factory settings, hold down the [PRESET] key during the boot process.

13.2 Disabling the Touchscreen

In certain situations, the capacitive touchscreen can get stimulated without touching it. Typical situations are:

- Measuring in an environment with immissions considerably higher than specified
- Measuring on power electronics with strong electric fields
- Connecting the probe to power electronics DUTs with large voltages or fast rising edges

Due to the unwanted stimulation, the R&S RTH detects three or more fingers on the screen even though the display has not been touched. A message box informs about the detection of more than two fingers. In this case, operate the instrument using the keys and the wheel and disable the touchscreen.

- ▶ To disable the touchscreen, press the [SHIFT] key for 2 seconds.

13.3 Selfalignment

Access:  or "Setup" menu > "Selfalignment"

The self-alignment aligns the data from several input channels vertically and horizontally to synchronize the timebases, amplitudes and positions.

Recommendation on performing the self-alignment:

- When putting the instrument into operation for the first time
- After a firmware update
- Once a week
- When major temperature changes occur (> 5°)

The R&S RTH1002 provides an additional, separate self-alignment of the meter inputs.

NOTICE

Preparing the instrument for self-alignment

Make sure that the instrument has been running and warming up before you start the self-alignment. The minimum warm-up time is indicated in the data sheet.

Before the self-alignment, remove all probes, leads, and other connected lines from the instrument input.

Selfalignment

Select Alignment Step:

Scope Vertical Only

Full

Start Selfalignment

Selfalignment	Result
LVDS	Ok
SADRadix	Ok
Interleave	Ok
SADRadixAB	Ok
Iso	Ok
Vertical	Ok
DMM	Ok

Last performed
2018-07-20 14:51:05

State
Passed

For best results instrument should be warmed up (running for more than 30 minutes) when starting alignment. During alignment nothing should be connected to the inputs of the oscilloscope. "Full" alignment is recommended.

The selfalignment may take up to : 15 minutes.

Figure 13-1: Self-alignment in scope mode

- To start, tap "Start Selfalignment".

The alignment can take up to 15 minutes. The results are shown in the "Selfalignment" dialog box.

R&S RTH1002: Self-alignment of DMM inputs

If the instrument is in "Meter" mode, you can choose to align all inputs, or only the meter inputs. The self-alignment of the meter inputs takes up to 30 seconds, while the complete self-alignment takes up to 15 minutes.

Selfalignment

Select Alignment Step:

DMM Only

Full

Start Selfalignment

Selfalignment	Result
LVDS	Ok
SADRadix	Ok
Interleave	Ok
SADRadixAB	Ok
Iso	Ok
Vertical	Ok
DMM	Ok

Last performed
2018-07-20 14:51:05

State
Passed

For best results instrument should be warmed up (running for more than 30 minutes) when starting alignment. During alignment nothing should be connected to the inputs of the oscilloscope. "Full" alignment is recommended.

The selfalignment may take up to : 15 minutes.

Figure 13-2: Self-alignment in meter mode

13.4 Setting the Date, Time and Language

The instrument has a date and time clock. You can adjust the clock to the local time, and you can select the display language. Supported languages are listed in the data sheet. The help is provided in English.

A reboot of the instrument is not necessary.

Set date and time

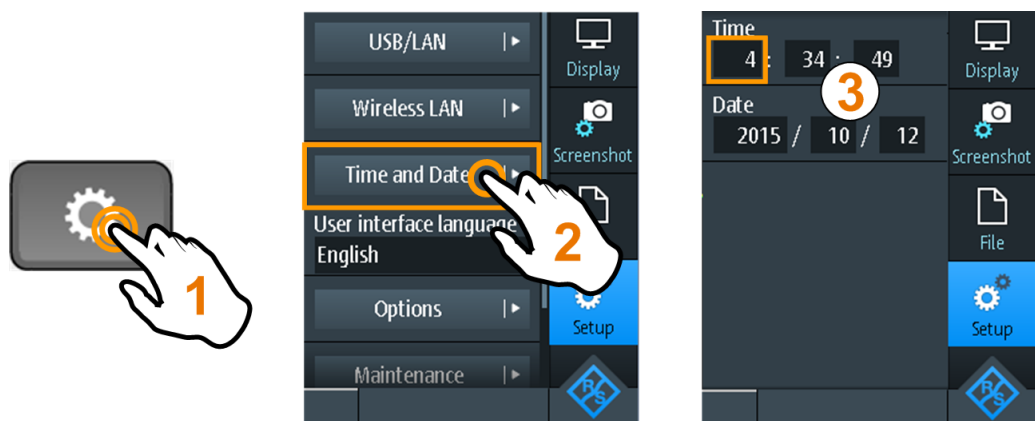

Set display language**☰ Description of settings****User Interface Language**

Select the language in which the functions and messages are displayed. Supported languages are listed in the data sheet. The help is provided in English.

The instrument changes the language after a few seconds, a reboot is not required.

Time

Set the local time in the following order: hours / minutes / seconds.

Remote command:

[SYSTem:TIME](#) on page 507

Date

Set the date in the following order: year / month / day.

Remote command:

[SYSTem:DATE](#) on page 506

13.5 Instrument Settings

Access:  or "Setup" menu



Enable Touch

Switches the touch functionality of the screen on or off. Alternatively, you can press the [SHIFT] key for 2 seconds.

In certain situations, the capacitive touchscreen can get stimulated without touching it. Typical situations are:

- Measuring in an environment with immissions considerably higher than specified
- Measuring on power electronics with strong electric fields
- Connecting the probe to power electronics DUTs with large voltages or fast rising edges

Due to the unwanted stimulation, the R&S RTH detects three or more fingers on the screen even though the display has not been touched. A message box informs about the detection of more than two fingers. In this case, operate the instrument using the keys and the wheel and disable the touchscreen.

Remote command:

`DISPlay:MOUS` on page 508

Selfalignment

See [Chapter 13.3, "Selfalignment"](#), on page 284.

Selftest

The self-test checks the hardware of the instrument. It is intended for service tasks.

USB/LAN

See [Chapter 14.1, "LAN Connection"](#), on page 295 and [Chapter 14.2, "USB connection"](#), on page 297.

Wireless LAN

See [Chapter 14.4, "Wireless LAN Connection \(Option R&S RTH-K200/200US\)"](#), on page 299.

Time and Date

See [Chapter 13.4, "Setting the Date, Time and Language"](#), on page 286.

User Interface Language

See [Chapter 13.4, "Setting the Date, Time and Language"](#), on page 286.

Options

See [Chapter 13.7, "Options"](#), on page 291.

Maintenance

The "Device Info" tab provides service information for your R&S RTH. If you need support, you may be asked to provide this information. Here you can also read the "Open Source Acknowledgment", which provides verbatim license text of open-source software that is used in the instrument's firmware.

The "Service" tab allows the service personnel to enter a password that activates further service functions. Without password, you can create a service report if there are problems. See [Chapter 2.5.3, "Information for Technical Support"](#), on page 38 for details.

Firmware Update

See [Chapter 13.8, "Updating the Firmware"](#), on page 293.

13.6 Display Settings

Access: "Display" menu

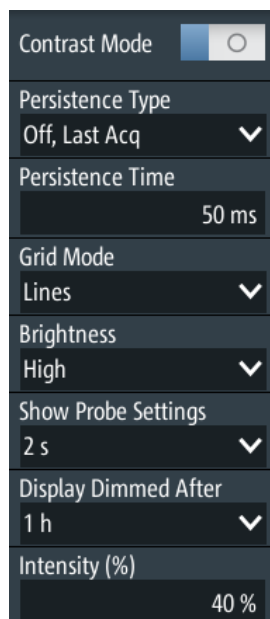

Contrast Mode

If enabled, the waveforms are displayed in black color on white background.

Remote command:

`DISPlay:CONTRast` on page 508

Persistence Type

Defines how long every new data point remains on the screen.

- "Off, Last Acq" Deactivates persistence and displays the last acquisition.
- "Off, Multiple Acq" Deactivates persistence and displays multiple acquisitions.
- "Time" Data points remain on the screen for the duration defined with [Persistence Time](#).
- "Infinite" Data points remain on the screen infinitely until persistence is set to "Off, Multiple Acq".

Remote command:

`DISPlay:PERSistence[:TYPE]` on page 507

Persistence Time

User-defined persistence time if "Persistence Type" is "Time". Each new data point remains on the screen for the duration defined here.

Remote command:

`DISPlay:PERSistence:TIME` on page 508

Grid Mode

Defines the grid display. A grid helps you identify the position of specific data points.

- "Off" No grid is shown.
- "Dots" Dots mark the intersections of the gridlines.
- "Lines" Displays the grid as horizontal and vertical lines.

Brightness

Changes the brightness of the touchscreen.

Show Probe Settings

Defines how long the probe settings of active channels are shown when you press a channel key. The settings are shown on the top of the display.

The probe settings are always shown as long as the "Vertical" menu is open.

Display Dimmed After

Defines when the display switches off if it is not used. Switching off the display saves energy and prolongs the battery's operating time.

Intensity (%)

Changes the intensity of the waveforms on the screen.

13.7 Options

All options are activated by license keys. No additional installation or hardware change is required.



Unregistered licenses

Unregistered licenses are not assigned to a particular instrument. The instrument accepts only registered licenses. If your license is delivered unregistered, use the online tool R&S License Manager to register the license for your instrument. The registration of a permanent license is irreversible, so ensure that you register it for the correct instrument. The address of the tool is <https://extranet.rohde-schwarz.com/service>.

The "Active options" tab provides information on installed software options. Here you can install new options or deactivate existing options using license keys.

Active options		Inactive options	Deactivated options
Description	Activation type	Valid until	
K1 I2C/SPI Trigger & Decode	Permanent		
K2 UART/RS232 Trigger & Decode	Permanent		
B1 Mixed-Signal-Opt. 250 MHz	Permanent		
B242 200 MHz Option, RTH1004	Permanent		
K19 Advanced Trigger	Permanent		
K200 Wireless LAN	Permanent		

Required information to order an option		Install a new option
Material number	1317.5000K04	<input type="text" value="Enter new option key"/> <input type="button" value="Install from file ..."/>
Serial number	900079	
Device ID	1317.5000K04-900079-Fw	

The "Inactive options" tab lists all deactivated and expired options.

Active options		Inactive options		Deactivated options	
Description	Activation type	Valid until	Remark		
K200 Wireless LAN	Permanent	-	deactivated		

The "Deactivated options" tab shows all deactivated options with their deactivation information and provides a function to export the deactivation response. The response is required by the R&S License Manager.

Active options		Inactive options		Deactivated options	
Description	Key	Response			
K200 Wireless LAN	010263902420031714993030926!	04690C3456E8B8B6B			

 Export deactivation response ...

13.7.1 Activating Options

Consult your sales representative and provide the material number, serial number, and the device ID of your instrument to get a license key. You find this information in  > "Options" > "Active options".

The license key is provided in written form or in a file. Unregistered licenses must be registered in the R&S License Manager before they can be activated on the instrument.

1. If you received the option key in a file, save the file to a USB flash drive, and connect the drive to the R&S RTH.
2. Press the  key.
3. Select "Options", and select the "Active options" tab.

Active options			Inactive options	Deactivated options
Description	Activation type	Valid until		
K1 I2C/SPI Trigger & Decode	Permanent			
K2 UART/RS232 Trigger & Decode	Permanent			
B1 Mixed-Signal-Opt. 250 MHz	Permanent			
B242 200 MHz Option, RTH1004	Permanent			
K19 Advanced Trigger	Permanent			
K200 Wireless LAN	Permanent			

Required information to order an option		Install a new option
Material number	1317.5000K04	Enter new option key
Serial number	900079	<input type="text"/>
Device ID	1317.5000K04-900079-Fw	 Install from file ...

4. If you received a key in written form, enter the key in the "Enter new option key" field.
If you received a key in digital form as a file, tap "Install from file", select path / media/USB1, and select the option key file.
5. If you want to activate several options, repeat step 3 for each option.
6. Restart the instrument.

13.8 Updating the Firmware

Your instrument is delivered with the latest firmware version. Firmware updates are provided on the Internet at www.rohde-schwarz.com/product/rth.html > "Downloads" > "Firmware". Along with the firmware file, you find the Release Notes describing the improvements and modifications.

Make sure to update the firmware if a new version is available.

1. Download the firmware installation file RTH*.rsi, and save it to a USB flash drive.
2. Connect the USB flash drive to the USB connector on the right panel of the instrument.
3. Press .
4. Scroll down the menu and tap "Open File" under "Firmware Update".

5. Select the firmware file.

If you cannot see the `RTH*.rsi` file, select the path `/media/USB1`, and the folder that contains the file.

6. Tap "Select".

7. Tap "Yes".

The firmware update starts. Wait until the update has finished. The instrument restarts automatically.

14 Network Connections

This chapter describes the setup of network connections.

There are several ways to connect the R&S RTH to a computer:

- Connect the instrument to a local area network (LAN), usually the company network. For this connection, ethernet technology is used.
LAN connection is used for remote operation using the web interface option R&S RTH-K201, for remote control using SCPI commands, and for data transfer.
- Connect the instrument directly to a computer using USB.
The direct USB connection is used for remote control using SCPI commands.
- Connect the instrument to the wireless LAN (requires option R&S RTH-K200).
You can operate the instrument remotely using a web browser on the computer or mobile device.

14.1 LAN Connection

1. Connect the LAN cable to the LAN connector on the right panel of the instrument.
2. Press the  key.
3. Select "USB/LAN".
4. Select "Interface" = "Ethernet". By default, DHCP is used and all address information is assigned automatically.
5. Note the IP address, which is required to address the instrument in the network.

Description of settings

Interface	Ethernet 
Status	Ready (Eth. connected)
Hostname	RTH-900079
DHCP	<input checked="" type="checkbox"/>
IP Address (DHCP)	10.113.1.159
Subnet mask (DHCP)	255.255.252.0
Gateway (DHCP)	10.113.0.1
DNS Server (DHCP)	10.0.2.166
MAC Address	00:90:B8:1D:E4:70

Interface

Select LAN or USB connection.

Status

Shows the connection status.

Hostname

Shows the computer name of the instrument.

In a LAN that uses a Domain Name System server (DNS server), each computer or instrument can be accessed using a unique name instead of the IP address. The DNS server translates the host name to the IP address. The host name is useful when a DHCP server is used, as a new IP address is assigned each time the instrument is restarted.

The default name is RTH-<serial_number>. You can change the name, but make sure that the name is unique in the LAN.

DHCP

Enables dynamic TCP/IP configuration using the Dynamic Host Configuration Protocol (DHCP). If DHCP is on, all address information is assigned automatically. Disable DHCP if the network does not support this protocol.

IP Address, Subnet mask, Gateway, DNS Server

Shows the IP address and other address information for LAN connection.

If the network supports DHCP, the DHCP server assigns these parameters. It is safe to establish a connection to the LAN without any previous instrument configuration.

If DHCP is not supported, enter the address information manually (static address).

Note: Risk of network errors. Connection errors can affect the entire network. If your network does not support DHCP, or if you disable DHCP, make sure to assign valid address information before connecting the instrument to the LAN. To obtain a valid IP address, subnet mask, and gateway, contact your network administrator.

MAC Address

Shows the media access control address (MAC address), a physical address and a unique identifier of the instrument.

14.2 USB connection

The USB device connector is intended to connect a computer directly to the instrument. You need a VISA communication tool installed on the computer to control the instrument using remote commands.

1. Connect a USB cable to the USB mini-B connector on the right panel of the instrument, and to a computer.
2. Press the  key.
3. Select "USB/LAN".
4. Select "Interface" = "USB".
The instrument shows the connection status.
5. When the computer detects the connected instrument, the drivers are automatically installed, and a message is displayed.
The drivers are IVI drivers
6. Open the Device Manager on the computer and check if the connected instrument is shown.

14.3 Web File Browser

If the R&S RTH is connected to a computer via LAN or WLAN (with option R&S RTH-K200/200US), you can use the web file browser to organize the data that is saved on the instrument. You can copy files, download files to the computer, upload files to the instrument, delete and rename files, and create folders..

1. Open a web browser on the computer or mobile device.
2. Type the instrument's host name or IP address in the address field of the browser, for example, *http://10.123.11.234*.

You can find the IP address on the R&S RTH under  key > "USB/LAN" > "Interface" = "Ethernet" > "IP Address".

Select item and choose operation below.

SD	
python	
Rohde-Schwarz	
RTH	
Export	
Harmonic	
install	
log	
ReferenceCurves	
SaveSets	
Screenshots	
Slots	
SaveSetHarmonicTest.xml	282 kB , 2019-08-01 11:11
SystemRestoration.xml	309 kB , 2019-08-05 15:59
SystemRestoration.xml.old	310 kB , 2019-08-05 15:41
System Volume Information	
axisserver.py	28 kB , 2016-02-29 16:50
BOOT.BIN	6290 kB , 2019-08-01 10:30
BOOT.bin.2_0_11_1_linux	6290 kB , 2017-02-28 17:08
RTH_Update_1.60.1.73_Beta.rsi	71467 kB , 2017-03-24 16:15
ScopeRider_1317.5000K04-900106-SC_2018_06_28_12_15_08.report	108 kB , 2018-06-28 12:15
start_firmware.sh.bak	3 kB , 2017-05-12 14:57
zImage	2408 kB , 2019-08-01 10:30
USB1	

Current item:
/media/SD/Rohde-Schwarz/RTH

Copy-destination:

Download Delete Rename New Folder Set As Destination Copy

Upload to the current folder:
 Browse... Submit Query

To download, delete or rename files or folders

1. Select the file or folder in the browser. You can also select several files or folders.
2. Select the action: "Download", "Delete", or "Rename".
3. Use the browser function "Save" or "Save as" to save the file on the computer.
If you download more than one file or a folder, the download is saved as a ZIP file.

To copy files or folders

1. Select the target directory in the browser.
2. Select "Set As Destination".
3. In the browser, select the files or folders to be copied.

4. Select "Copy".

To upload a file to the instrument

1. Select the target directory in the browser.
2. Select "Browse".
3. In the file browser of the computer, select the file to be uploaded.
4. In the file browser of the computer, select "Open".
5. In the "RTH File Browser", select "Submit Query".

The file is copied to the target folder.

14.4 Wireless LAN Connection (Option R&S RTH-K200/200US)

Using the wireless LAN option R&S RTH-K200/200US, you can control your instrument with a portable device. Thus, you can perform dangerous measurements without risk.

When the instrument is connected to the portable device, the waveform display and user interface of the R&S RTH are directly available in the web browser. All settings can be changed in the browser, no software installation is required.

There are two ways to connect via wireless LAN:

- Usually, the R&S RTH is the access point and you set up connection on the portable device.
- The R&S RTH is the client that connects to a router or access point.



As any other wireless LAN connection, also the WLAN connection between the R&S RTH and the mobile device can be disturbed by various influences, for example, interfering signals.

To enable wireless LAN

1. Press the  key.
2. Tap "Wireless LAN".
3. Only for option R&S RTH-K200: Select the "Country", where you use the instrument.
The list contains all countries where the wireless LAN option has been approved. You also can find the list in the data sheet.
4. Enable "Wireless State".

Now you can connect the instrument.

To use the instrument as access point

1. Press the  key.
2. Tap "Wireless LAN".
3. Only for option R&S RTH-K200: Select the "Country", where you use the instrument.
The list contains all countries where the wireless LAN option has been approved. You also can find the list in the data sheet.
4. Select "Wireless Mode" = "Access Point" in the "Wireless LAN" menu.
5. If you connect for the first time, change the default "Passphrase". You can also change the identifier of the instrument, the "SSID".
6. Enable "Wireless State".
7. On your portable device, set up the connection to the instrument. Select the SSID, and enter the passphrase.
The detailed procedure is described in the documentation of your portable device.

To use the instrument as client

1. Press the  key.
2. Tap "Wireless LAN".
3. Only for option R&S RTH-K200: Select the "Country", where you use the instrument.
The list contains all countries where the wireless LAN option has been approved. You also can find the list in the data sheet.
4. Select "Wireless Mode" = "Client" in the "Wireless LAN" menu.
5. Enable "Wireless State".
The "Choose Access Point" window opens.
6. Tap the "SSID" of the required router.
7. Enter the password of the required router in "Passphrase".
The connection status is shown in "Status"

 **Description of settings**

Wireless State	<input checked="" type="checkbox"/>
Wireless Mode	Access point
SSID	RTH-900031
Passphrase	fmORg7VD
Status	Access point ready
IP Address	192.168.0.1
MAC Address	00:90:B8:1E:9D:88

Country

Select the country, where you use the wireless LAN. The list contains all countries where the wireless LAN option has been approved.

Only available in option R&S RTH-K200.

Wireless State

Enables or disables wireless LAN access.

Wireless Mode

Selects the wireless LAN function of the instrument. It can serve as access point or as client.

Remote command:

[SYSTem:COMMunicate:WLAN:MODE](#) on page 508

SSID

Shows the wireless LAN identifier of the instrument. You can change the identifier.

Passphrase

Shows the wireless LAN password of the instrument. You can change the password.

Status

Shows the connection status and activities.

IP Address

Shows the IP address of the instrument. You need this address to set up connection on the portable device.

MAC Address

Shows the media access control address (MAC address), a physical address and unique identifier of the instrument.

14.5 Web Interface (Option R&S RTH-K201)

If the R&S RTH is connected to a computer via LAN or WLAN (with option R&S RTH-K200/200US), you can operate the instrument from the computer. No additional tools are required, you need only a web browser that supports HTML5. Thus, you can use your smartphone or tablet to operate the oscilloscope remotely.

1. Open a web browser on the computer or mobile device.
2. Type the instrument's host name or IP address in the address field of the browser, for example, *http://10.133.10.203*.

The instrument's homepage is shown.

Using the web interface, you can:

- Display a screenshot of the current instrument display.
- Operate the instrument using the menus on the emulated display. This view is designed for small devices, for example, smartphones.
- Operate the instrument using the emulated front panel. You see a live image of the instrument. You can use the keys, the wheel and the menus in the same way as directly on the instrument.
- Organize the data that is saved on the instrument. You can download files to the computer, upload files to the instrument, delete and rename files, and create folders.



The instrument is connected to the Web interface using http. Encrypted access using https is not available. The usual risks of unsecured web connection exist also to the connection of the R&S RTH.

15 Remote Control Commands

15.1 Conventions used in Command Description

Note the following conventions used in the remote command descriptions:

- Command usage**
 If not specified otherwise, commands can be used both for setting and for querying parameters.
 If a command can be used for setting or querying only, or if it initiates an event, the usage is stated explicitly.
- Parameter usage**
 If not specified otherwise, a parameter can be used to set a value and it is the result of a query.
 Parameters required only for setting are indicated as **Setting parameters**.
 Parameters required only to refine a query are indicated as **Query parameters**.
 Parameters that are only returned as the result of a query are indicated as **Return values**.
- Conformity**
 Commands that are taken from the SCPI standard are indicated as **SCPI confirmed**. All commands used by the R&S RTH follow the SCPI syntax rules.
- Asynchronous commands**
 A command which does not automatically finish executing before the next command starts executing (overlapping command) is indicated as an **Asynchronous command**.
- Reset values (*RST)**
 Default parameter values that are used directly after resetting the instrument (*RST command) are indicated as ***RST** values, if available.
- Default unit**
 The default unit is used for numeric values if no other unit is provided with the parameter.

15.2 Mode

OP[:MODE] <OperationMode>

Sets the operating mode of the instrument.

Parameters:

<OperationMode> YT | XY | MASK | ROLL | METer | FFT | LOGGer | COUNter |
 PROToCol | HARMonic | SPECTrum
 *RST: YT (scope mode)

15.3 Waveform Setup

- [Automatic Setup](#)..... 304
- [Vertical Setup](#)..... 304
- [Horizontal Setup](#)..... 310
- [Acquisition Control](#)..... 311
- [Trigger](#)..... 314

15.3.1 Automatic Setup

AUToscale

Performs an autoset in scope mode.

Usage: Event

15.3.2 Vertical Setup

The channel suffix <m> selects the channel for which the command is executed. The number of channels depends on the instrument type. The R&S RTH1004 has 4 channels, the suffix values are 1 | 2 | 3 | 4. The R&S RTH1002 has 2 channels, the suffix values are 1 | 2.



Make sure to set the attenuation factor on the instrument according to the probe being used. Otherwise, the measurement results do not reflect the actual voltage level, and you might misjudge the actual risk.

- [CHANnel<m>:STATe](#)..... 304
- [CHANnel<m>:SCALe](#)..... 305
- [CHANnel<m>:RANGe](#)..... 305
- [CHANnel<m>:PROBe](#)..... 305
- [PROBe<m>:SETup:ATTenuation:MANual](#)..... 306
- [PROBe<m>:SETup:ATTenuation:UNIT](#)..... 306
- [CHANnel<m>:POSition](#)..... 307
- [CHANnel<m>:OFFSet](#)..... 307
- [CHANnel<m>:COUPLing](#)..... 307
- [CHANnel<m>:BANDwidth](#)..... 308
- [CHANnel<m>:POLarity](#)..... 308
- [CHANnel<m>:DESKew](#)..... 308
- [CHANnel<m>:THReshold:TECHnology](#)..... 309
- [CHANnel<m>:THReshold:USER](#)..... 309
- [CHANnel<m>:THReshold:THReshold?](#)..... 309
- [CHANnel<m>:THReshold:FINDlevel](#)..... 310

CHANnel<m>:STATe <State>

Switches the channel signal on or off.

Suffix:

<m> 1|2 (RTH1002) , 1..4 (RTH1004)

Parameters:

<State> ON | OFF
*RST: OFF

CHANnel<m>:SCALE <Scale>

Sets the vertical scale (vertical sensitivity) of the indicated waveform.

Suffix:

<m> 1|2 (RTH1002) , 1..4 (RTH1004)

Parameters:

<Scale> Scale value, given in Volts per division
Range: 2E-3 to 100
Increment: 1E-3
*RST: 0.05
Default unit: V/div

CHANnel<m>:RANGe <Range>

Sets the voltage range across the 8 vertical divisions of the diagram. Use the command alternatively to [CHANnel<m>:SCALE](#).

Suffix:

<m> 1|2 (RTH1002) , 1..4 (RTH1004)

Parameters:

<Range> Voltage range value
Range: 200E-9 to 8E+6
Increment: 10E-6
*RST: 0.4
Default unit: V

CHANnel<m>:PROBe <ProbeSettings>

Sets the attenuation factor of the connected probe. The vertical scaling is adjusted accordingly, and measured values are multiplied by this factor so that the displayed values are equal to the actual signal values.

Make sure to set the attenuation factor on the instrument according to the probe being used. Otherwise, the measurement results do not reflect the actual voltage level, and you might misjudge the actual risk.

If AC coupling is set, the attenuation of passive probes has no effect, and voltage is applied to the instrument with factor 1:1. Observe the voltage limits, otherwise you can damage the instrument.

Suffix:

<m> 1|2 (RTH1002) , 1..4 (RTH1004)

Parameters:

<ProbeSettings> V1TO1 | V10To1 | V20To1 | V100to1 | V200to1 | V1000to1 |
C100V1A | C10V1A | C1V1A | C100MV1A | C10MV1A |
C1MV1A | T1MVC | T1MVF | PT100 | PT500 | PT1000 | USER
V1TO1 | V10To1 | V20To1 | V100To1 | V200To1 | V1000To1
Attenuation factors of voltage probes: 1:1, 10:1, 20:1, 100:1,
200:1, 1000:1.
C100V1A | C10V1A | C1V1A | C100MV1A | C10MV1A |
C1MV1A
Sensitivity of current probes: 100 V/A, 10 V/A, 1 V/A, 100 mV/A,
10 mV/A, 1 mV/A.
T1MVC | T1MVF | TPTC | TPTF
Temperature adapter type: 1 mV/°C, 1 mV/°F, PT100(°C),
PT100(°F)
USER
Set a user-defined attenuation factor if the predefined values do
not fit: Use `PROBe<m>:SETup:ATTenuation:MANual` to set
the value and `PROBe<m>:SETup:ATTenuation:UNIT` to set
the unit.
*RST: V1TO1

PROBe<m>:SETup:ATTenuation:MANual <ProbeFactor>

Sets a user-defined attenuation factor if `CHANnel<m>:PROBe` is set to `USER`.

Suffix:

<m> 1|2 (RTH1002) , 1..4 (RTH1004)

Parameters:

<ProbeFactor> Range: 100E-6 to 10000
Increment: 100E-6
*RST: 1

PROBe<m>:SETup:ATTenuation:UNIT <ProbeUnit>

Sets a user-defined probe unit if `CHANnel<m>:PROBe` is set to `USER`.

Suffix:

<m> 1|2 (RTH1002) , 1..4 (RTH1004)

Parameters:

<ProbeUnit> V | A
*RST: V

CHANnel<m>:POSition <Position>

Moves the selected signal up or down in the diagram. The position is a graphical setting given in divisions, while the offset sets a voltage.

Suffix:

<m> 1|2 (RTH1002) , 1..4 (RTH1004)

Parameters:

<Position> Position value, given in divisions.
 Range: -4 to 4
 Increment: 0.5
 *RST: 0
 Default unit: div

CHANnel<m>:OFFSet <Offset>

Sets an offset voltage that is added to correct an offset-affected signal. The value is included in measurement results. The signal is shifted in relation to the ground level by the offset value. Negative offset values move the waveform down, positive values move it up.

Suffix:

<m> 1|2 (RTH1002) , 1..4 (RTH1004)

Parameters:

<Offset> Range: -400 to 400
 Increment: 0.5
 *RST: 0
 Default unit: V

CHANnel<m>:COUPling <Coupling>

Selects the connection of the indicated channel.

If AC coupling is set, the attenuation of passive probes has no effect, and voltage is applied to the instrument with factor 1:1. Observe the voltage limits, otherwise you can damage the instrument.

Suffix:

<m> 1|2 (RTH1002) , 1..4 (RTH1004)

Parameters:

<Coupling> DCLimit | ACLimit

DCLimit

The signal passes the input unchanged.

ACLimit

A high-pass filter removes the DC offset voltage from the input signal if the DC component of a signal is of no interest.

*RST: DCLimit

CHANnel<m>:BANDwidth <BandwidthLimit>

Selects the bandwidth limit for the indicated channel.

Suffix:

<m> 1|2 (RTH1002) , 1..4 (RTH1004)

Parameters:

<BandwidthLimit> FULL | B350 | B200 | B100 | B60 | B50 | B40 | B20 | B10 | B5 | B4 | B2 | B1 | B5HK | B4HK | B2HK | B1HK | B50K | B40K | B20K | B10K | B5K | B4K | B2K | B1K

FULL

At full bandwidth, all frequencies in the specified range are acquired and displayed.

B350 | B200 | B100 | B60 | B50 | B40 | B20 | B10 | B5 | B4 | B2 | B1

Limit to 350 MHz, 200 MHz, 100 MHz, 60 MHz,..., respectively.

B5HK | B4HK | B2HK | B1HK | B50K | B40K | B20K | B10K | B5K | B4K | B2K | B1K

Limit to 500 kHz, 400 kHz,..., respectively.

*RST: FULL

CHANnel<m>:POLarity <Polarity>

Turns the inversion of the signal amplitude on or off. To invert means to reflect the voltage values of all signal components against the horizontal display center. Inversion affects only the display of the signal but not the trigger.

Suffix:

<m> 1|2 (RTH1002) , 1..4 (RTH1004)

Parameters:

<Polarity> NORMal | INVerted

*RST: NORMal

CHANnel<m>:DESKew <Deskew>

Sets a delay for the selected channel.

Deskew compensates delay differences between channels caused by the different length of cables, probes, and other sources.

Suffix:

<m> 1|2 (RTH1002) , 1..4 (RTH1004)

Parameters:

<Deskew> Deskew value

Range: -100E-9 to 100E-9

Increment: 800E-12

*RST: 0

Default unit: s

CHANnel<m>:THReshold:TECHnology <ThresholdType>

Sets the threshold value for digitization of analog signals. If the signal value is higher than the threshold, the signal state is high (1 or true for the boolean logic). Otherwise, the signal state is considered low (0 or false) if the signal value is below the threshold.

Suffix:

<m> 1|2 (RTH1002) , 1..4 (RTH1004)

Parameters:

<ThresholdType> TTL | ECL | CMOS | CAN | GND | LIN7vsupply | LIN12vsupply | LIN18vsupply | USER

TTL

1.4 V

ECL

-1.3 V

CMOS

2.5 V

GND

0 V (for CAN channels, requires option R&S RTH-K3)

CAN

2 V (for CAN channels, requires option R&S RTH-K3)

LIN7vsupply | LIN12vsupply | LIN18vsupply

7 V / 12 V / 18 V (for LIN channels, requires option R&S RTH-K3)

USER

Set the value with `CHANnel<m>:THReshold:USER`.

*RST: TTL

CHANnel<m>:THReshold:USER <ThresholdValue>

Set an individual threshold value if `CHANnel<m>:THReshold:TECHnology` is set to USER.

Suffix:

<m> 1|2 (RTH1002) , 1..4 (RTH1004)

Parameters:

<ThresholdValue> Range: -400 to 400
Increment: 1E-3
*RST: 1.4
Default unit: V

CHANnel<m>:THReshold:THReshold?

Returns the threshold value.

Suffix:

<m> 1|2 (RTH1002) , 1..4 (RTH1004)

Return values:

<Level> Range: -10 to 10
 Increment: 1E-3
 *RST: 0
 Default unit: V

Usage: Query only

CHANnel<m>:THReshold:FINDlevel

The instrument sets the threshold for the selected channel.

Suffix:

<m> 1|2 (RTH1002) , 1..4 (RTH1004)

Usage: Event

15.3.3 Horizontal Setup

TIMebase:SCALe	310
TIMebase:RANGe	310
TIMebase:HORizontal:POSition	310
TIMebase:REFerence	311

TIMebase:SCALe <Scale>

Sets the time scale of the horizontal axis for all signals.

Parameters:

<Scale> Range: 1E-9 to 500
 Increment: Steps 1, 2, 5 (1, 2, 5, 10, 20, 50, 100, 200, 500...)
 *RST: 100E-9
 Default unit: s/div

TIMebase:RANGe <AcquisitionTime>

Sets the acquisition time, the timerange across the 10 horizontal divisions of the diagram. Use the command alternatively to [TIMebase:SCALe](#).

Parameters:

<AcquisitionTime> Range: 10E-9 to 5000
 Increment: Steps 1, 2, 5 (1, 2, 5, 10, 20, 50, 100, 200, 500...)
 *RST: 1E-6
 Default unit: s

TIMebase:HORizontal:POSition <Position>

Sets the horizontal position of the trigger point in relation to the reference point.

See also: "[Horizontal Position](#)" on page 47

Parameters:

<Position> Range: Depends on the time scale, see table below.
 Increment: 0.1
 *RST: 0
 Default unit: s

Time scale	Min./max. horizontal position
1 ns/div to 100 µs/div	±2 s
200 µs/div to 2 s/div	<i>Time scale * 20000</i>
5 s/div – 500 s/div	100000 s

TIMEbase:REFerence <ReferencePoint>

Defines the time reference point in the diagram.

Parameters:

<ReferencePoint> Position of the reference point in percent of the screen width.
 Available values are:
 10: on the left side of the screen
 50: in the middle of the screen
 90: on the right side
 *RST: 50
 Default unit: %

15.3.4 Acquisition Control

RUN.....	311
STOP.....	311
ACQUIRE:MODE.....	312
ACQUIRE:AVERAge:COUNT.....	312
ACQUIRE:ARESet:IMMEDIATE.....	312
ACQUIRE:POINts:PRESelect.....	312
ACQUIRE:WAVEformupd.....	313
ACQUIRE:POINts:ARATE?.....	313
ACQUIRE:POINts:VALue]?.....	313
ACQUIRE:RESolution?.....	314

RUN

Starts the continuous acquisition.

Usage: Event

STOP

Stops the running acquisition.

Usage: Event

ACQUIRE:MODE <AcquisitionMode>

Defines how the waveform is built from the captured samples.

Parameters:

<AcquisitionMode> SAMPLE | PDETECT | HRESOLUTION | AVERAGE | ENVELOPE

SAMPLE

One of n samples in a sample interval is recorded as waveform point, the other samples are discarded.

PDETECT

The minimum and the maximum of n samples are recorded as waveform points, the other samples are discarded.

HRESOLUTION

The average of n captured sample points is recorded as one waveform point.

AVERAGE

The average is calculated from the data of the current acquisition and a number of acquisitions before. The number of acquisitions for average calculation is defined with **ACQUIRE: AVERAGE: COUNT**.

ENVELOPE

The minimum and maximum values in an sample interval over a number of acquisitions are saved. The most extreme values of all acquisitions build the envelope.

*RST: SAMPLE

ACQUIRE:AVERAGE:COUNT <NoOfAves>

Sets the number of waveforms used to calculate the average waveform.

Parameters:

<NoOfAves> Range: 2 to 8192
 Increment: 2^N (N = 1 .. 13)
 *RST: 2

ACQUIRE:ARESET:IMMEDIATE

Restarts the envelope and average calculation.

Usage: Event

ACQUIRE:POINTS:PRESELECT <RecLength>

Sets the record length.

Parameters:

<RecLength> MAX | MIDDLE | MIN

MAX

Sets the maximum possible record length.

MIDDLE

Limits the record length to 12.5 kSample.

MIN

Limits the record length to 1.25 kSample.

*RST: MAX

The actual record length can differ from these limits, see "[Act. Record Len. C1 - C4](#)" on page 50.

ACQUIRE:WAVEformupd <WaveformUpdate>

The command is relevant if the time scale is ≥ 50 ms/div. At these slow timebases, you can select how the acquired samples are displayed.

Parameters:

<WaveformUpdate> INTermediate | FULL

INTermediate

The acquired samples are displayed before the acquisition is completed. In this mode, the record length is limited to 125 kSamples.

FULL

The acquired samples are displayed when the complete acquisition has been recorded. Depending on the selected time scale, it takes some time until the waveform is visible. This mode does not limit the record length and is always used for time scales < 50 ms/div.

*RST: INTermediate

ACQUIRE:POINTS:ARATE?

Returns the number of captured analog waveform points per second (sample rate of the ADC).

Return values:

<ADCSampleRate> 1 active channel: 5 Gsample/s
 2 active channels: 2.5 Gsample/s
 3 or 4 active channels: 1.25 Gsample/s
 Default unit: Sa/s

Usage: Query only

ACQUIRE:POINTS[:VALue]?

Returns the record length, number of captured waveform samples before interpolation.

Return values:

<RecordLength> Range: 1 to 4294967295
 Increment: 1
 *RST: 1
 Default unit: Sa

Usage: Query only

ACquire:RESolution?

Returns the resolution, the time between two waveform samples.

Return values:

<ResolutionPP> Range: 1E-12 to 1E+12
 Increment: 1E-12
 *RST: 0
 Default unit: s

Usage: Query only

15.3.5 Trigger

- [General Trigger Settings](#)..... 314
- [Edge Trigger](#)..... 317
- [Glitch Trigger](#).....318
- [Width Trigger](#).....318
- [Video/TV Trigger](#)..... 320
- [External Trigger \(R&S RTH1002\)](#).....323
- [Pattern Trigger \(R&S RTH-K19\)](#).....324
- [State Trigger \(R&S RTH-K19\)](#).....326
- [Runt Trigger \(R&S RTH-K19\)](#).....327
- [Slew Rate Trigger \(R&S RTH-K19\)](#).....330
- [Data2Clock Trigger \(R&S RTH-K19\)](#).....332
- [Serial Pattern Trigger \(R&S RTH-K19\)](#)..... 333
- [Timeout Trigger \(R&S RTH-K19\)](#)..... 335
- [Interval Trigger \(R&S RTH-K19\)](#)..... 335
- [Window Trigger \(R&S RTH-K19\)](#)..... 337

15.3.5.1 General Trigger Settings

See also: [Chapter 3.6.1, "General Trigger Settings"](#), on page 53

- TRIGger:MODE..... 315
- TRIGger:SOURce..... 315
- TRIGger:TYPE..... 315
- TRIGger:LEVel<m>:VALue.....316
- TRIGger:HOLDoff:MODE.....316
- TRIGger:HOLDoff:TIME.....316
- TRIGger:HOLDoff:EVENTs..... 317

TRIGger:HOLDoff:MIN.....	317
TRIGger:HOLDoff:MAX.....	317
TRIGger:MNR.....	317

TRIGger:MODE <Mode>

The trigger mode determines the behavior of the instrument if no trigger occurs, and also the number of acquired waveforms when a trigger occurs.

Parameters:

<Mode> AUTO | NORMAl | SINGle

AUTO

The instrument triggers repeatedly after a time interval if the trigger conditions are not fulfilled. If a real trigger occurs, it takes precedence.

NORMAl

The instrument acquires waveforms continuously, each time when a trigger occurs.

SINGle

When a trigger occurs, the instrument acquires one waveform.

*RST: AUTO

TRIGger:SOURce <Source>

Selects the trigger source, the waveform on which the trigger condition is checked.

Parameters:

<Source> C1 | C2 | C3 | C4 | D0 | D1 | D2 | D3 | D4 | D5 | D6 | D7

Logic channels D0..D7 require option R&S RTH-B1. For video, runt, slew rate and window trigger, only analog channels are available.

*RST: C1

TRIGger:TYPE <Type>

Selects the trigger type, the event type that defines the trigger point.

Parameters:

<Type> EDGE | GLITch | WIDTH | TV | PATtern | STATe | RUNT | SLEWrate | DATatoclock | SERPattern | TIMEout | INTerval | WINDow | PROTocol

EDGE | GLITch | WIDTH | TV

Standard trigger types

PATtern | STATe | RUNT | SLEWrate | DATatoclock | SERPat-tern | TIMEout | INTerval | WINDow

Require option R&S RTH-K19

PROTocol

Requires option R&S RTH-K1 and/or R&S RTH-K2

*RST: EDGE

TRIGger:LEVel<m>:VALue <Level>

Sets the trigger level voltage. The command is relevant for all trigger types that require one trigger level.

Suffix:

<m> 1..21
 Indicates the trigger source:
 1..4: analog channels 1 to 4
 8..15: digital channels D0 to D7
 all others: not available

Parameters:

<Level> Range: -10 to 10
 Increment: 1E-3
 *RST: 0
 Default unit: V

TRIGger:HOLDOff:MODE <Mode>

Selects the method to define the holdoff.

Parameters:

<Mode> OFF | TIME | RANDom | EVENts

OFF

No holdoff

TIME

Defines the holdoff as a time period. The next trigger occurs only after a time has passed, which is defined with `TRIGger:HOLDOff:TIME`.

RANDom

Defines the holdoff as a random time limited by `TRIGger:HOLDOff:MIN` and `TRIGger:HOLDOff:MAX`. For each acquisition, the instrument selects a new random holdoff time from the specified range.

EVENts

Defines the holdoff as a number of trigger events, which is defined with `TRIGger:HOLDOff:EVENts`.

*RST: OFF

TRIGger:HOLDOff:TIME <Time>

Sets the time that has to pass at least until the next trigger occurs. The command takes effect if `TRIGger:MODE` is set to `TIME`.

Parameters:

<Time> Range: 8E-9 to 10
 Increment: 200E-6
 *RST: 1E-3
 Default unit: s

TRIGger:HOLDoff:EVENTs <Events>

Sets the number of triggers to be skipped until the next trigger occurs. The command takes effect if **TRIGger:MODE** is set to **EVENTs**.

Parameters:

<Events> Range: 1 to 1000000000
 Increment: 10
 *RST: 1

TRIGger:HOLDoff:MIN <RandomMinTime>**TRIGger:HOLDoff:MAX** <RandomMaxTime>

Set the time limits for random holdoff time. For each acquisition, the instrument selects a new random holdoff time from the specified range.

Parameters:

<RandomMinTime> Range: 8E-9 to 10
 <RandomMaxTime> Increment: 200E-6
 *RST: 2E-3
 Default unit: s

TRIGger:MNR <MoreNoiseReject>

Enables a hysteresis to avoid unwanted trigger events caused by noise oscillation around the trigger level.

Parameters:

<MoreNoiseReject> ON | OFF
 *RST: OFF

15.3.5.2 Edge Trigger**TRIGger:EDGE:SLOPe** <Slope>

Sets the edge to be triggered on.

Parameters:

<Slope> POSitive | NEGative | EITHER
 POSitive = rising edge
 NEGative = falling edge
 EITHER = rising and falling edge
 *RST: POSitive

15.3.5.3 Glitch Trigger

See also: [Chapter 3.6.3, "Glitch Trigger"](#), on page 56

TRIGger:GLITch:POLarity.....	318
TRIGger:GLITch:RANGe.....	318
TRIGger:GLITch:WIDTh.....	318

TRIGger:GLITch:POLarity <Polarity>

Sets the pulse polarity, that is the direction of the first pulse slope. You can trigger on:

- Positive going pulses. The width is defined from the rising to the falling edge.
- Negative going pulses. The width is defined from the falling to the rising edge.
- Both positive and negative going pulses

Parameters:

<Polarity> POSitive | NEGative | EITHer
 *RST: POSitive

TRIGger:GLITch:RANGe <Condition>

Selects the glitches to be identified: shorter or longer than the width specified with [TRIGger:GLITch:WIDTh](#).

Parameters:

<Condition> LONGer | SHORter
 *RST: LONGer

TRIGger:GLITch:WIDTh <Duration>

Sets the pulse width of the glitch.

Parameters:

<Duration> Range: 800E-12 to 10000
 Increment: 100E-9
 *RST: 5E-9
 Default unit: s

15.3.5.4 Width Trigger

See also [Chapter 3.6.4, "Width Trigger"](#), on page 57.

TRIGger:WIDTh:POLarity.....	319
TRIGger:WIDTh:RANGe.....	319
TRIGger:WIDTh:WIDTh.....	319
TRIGger:WIDTh:DELTA.....	319
TRIGger:WIDTh:MAX.....	320
TRIGger:WIDTh:MIN.....	320

TRIGger:WIDTH:POLarity <Polarity>

Sets the pulse polarity, that is the direction of the first pulse slope. You can trigger on:

- Positive going pulses. The width is defined from the rising to the falling edge.
- Negative going pulses. The width is defined from the falling to the rising edge.
- Both positive and negative going pulses

Parameters:

<Polarity> POSitive | NEGative | EITHer
 *RST: POSitive

TRIGger:WIDTH:RANGe <Condition>

Defines how the measured pulse width is compared with the given limit(s).

Parameters:

<Condition> LONGer | SHORter | EQUal | NEQual | WITHin | OUTSide

LONGer | SHORter

Triggers on pulses shorter or longer than a width set using [TRIGger:WIDTH:WIDTH](#).

EQUal | NEQual

Triggers on pulses equal or not equal a given width that is set using [TRIGger:WIDTH:WIDTH](#). In addition, a tolerance can be set around the specified width using [TRIGger:WIDTH:DELTA](#).

WITHin | OUTSide

Triggers on pulses inside or outside a given range. The range is set using [TRIGger:WIDTH:MIN](#) and [TRIGger:WIDTH:MAX](#).

*RST: LONGer

TRIGger:WIDTH:WIDTH <Duration>

Sets the width for comparison ranges EQUal, UNEQual, SHORter, and LONGer.

See [TRIGger:WIDTH:RANGe](#) on page 319

Parameters:

<Duration> Range: 800E-12 to 10000
 Increment: 100E-9
 *RST: 5E-9
 Default unit: s

TRIGger:WIDTH:DELTA <Tolerance>

Sets a range Δt to the specified width, which is defined using [TRIGger:WIDTH:WIDTH](#).

Parameters:

<Tolerance> Range: 0 to 5000
 Increment: 500E-12
 *RST: 0
 Default unit: s

TRIGger:WIDTh:MAX <MaxDuration>

Sets the upper limit for the pulse width if **TRIGger:WIDTh:RANGe** is set to WITHin or OUTSide.

Parameters:

<MaxDuration> Range: 800E-12 to 10000
 Increment: 100E-9
 *RST: 5E-9
 Default unit: s

TRIGger:WIDTh:MIN <MinDuration>

Sets the lower limit for the pulse width if **TRIGger:WIDTh:RANGe** is set to WITHin or OUTSide.

Parameters:

<MinDuration> Range: 800E-12 to 10000
 Increment: 100E-9
 *RST: 5E-9
 Default unit: s

15.3.5.5 Video/TV Trigger

The standards PAL, PAL-M, NTSC and SECAM are available in the instrument firmware. All other standards and custom signals require the advanced trigger option (R&S RTH-K19).

TRIGger:TV:STANdard.....	321
TRIGger:TV:POLarity.....	321
TRIGger:TV:MODE.....	321
TRIGger:TV:LINE.....	322
TRIGger:TV:LField.....	322
TRIGger:TV:CUSTom:STYPe.....	322
TRIGger:TV:CUSTom:LDURation.....	323
TRIGger:TV:CUSTom:SDURation.....	323
TRIGger:TV:CUSTom:SCANmode.....	323

TRIGger:TV:STANdard <Standard>

Selects the TV standard or **CUSTom** for user-defined signals.

Parameters:

<Standard>

PAL | PALM | NTSC | SECam | P480L60HZ | P576L50HZ |
P720L30HZ | P720L50HZ | P720L60HZ | I1080L50HZ |
I1080L60HZ | P1080L24HZ | P1080L24HZSF | P1080L25HZ |
P1080L30HZ | P1080L50HZ | P1080L60HZ | CUSTom

PAL | PALM | NTSC | SECam

Standards delivered with the instrument firmware.

PxxxxLyyHZ

HDTV standards using progressive scanning (P). xxxx indicates the number of active lines, yy is the frame rate.

Triggering on HDTV standards requires option R&S RTH-K19.

IxxxxLxxHZ

HDTV standards using interlaced scanning (I). xxxx indicates the number of active lines, yy is the field rate.

P1080L24HZSF

1080p/24sF is a HDTV standard using progressive segmented frame scanning.

CUSTom

Used for signals of other video systems, for example, medical displays, video monitors, and security cameras. Requires option R&S RTH-K19.

*RST: PAL

TRIGger:TV:POLarity <Polarity>

Sets the polarity of the signal. Note that the sync pulse has the opposite polarity, for example, a positive signal has a negative sync pulse.

Parameters:

<Polarity>

POSitive | NEGative

*RST: POSitive

TRIGger:TV:MODE <Mode>

Selects the lines or fields on which the instrument triggers. Available modes depend on the scanning system of the selected standard.

Parameters:

<Mode>

ALL | ODD | EVEN | ALINe | LINE

ALL

All fields: Triggers on the first video line of the frame (progressive scanning) or field (interlaced scanning), for example, to find amplitude differences between the fields.

ODD | EVEN

Odd fields / even fields: Triggers on the first video line of the odd or even field. These modes are available for interlaced scanning (PAL, PAL-M, SECAM, NTSC, 1080i) and progressive segmented frame scanning (1080p/24sF). They can be used, for example, to analyze the components of a video signal.

ALINE

All lines: Triggers on the line start of all video lines, for example, to find maximum video levels.

LINE

Triggers on a specified line. Specify the line number using `TRIGger:TV:LINE`.

*RST: ALL

TRIGger:TV:LINE <LineNumber>

Sets the number of the line to be triggered on if `TRIGger:TV:MODE` is `LINE`.

Usually the lines of the frame are counted, beginning from the frame start.

For NTSC signals, the lines are counted per field, not per frame. Therefore, you have to set the odd or even field using `TRIGger:TV:LField`, and the line number in the field.

Parameters:

<LineNumber>	Range:	1 to 3000
	Increment:	1
	*RST:	1

TRIGger:TV:LField <LineField>

Line field (odd or even) used as reference for counting the video lines. Used by the NTSC standard.

Parameters:

<LineField>	FIELD1 FIELD2
	*RST: FIELD1

TRIGger:TV:CUSTom:STYPe <SyncPulseType>

Sets the type of the sync pulse, either bi-level sync pulse (usually used in SDTV signals), or tri-level sync pulse (used in HDTV signals).

Parameters:

<SyncPulseType>	BIlevel TRIlevel
	*RST: BIlevel

TRIGger:TV:CUSTom:LDURation <LineDuration>

Sets the duration of a single video line, the time between two successive sync pulses.

Parameters:

<LineDuration> Range: 5E-6 to 200E-6
 Increment: 100E-9
 *RST: 64E-6
 Default unit: s

TRIGger:TV:CUSTom:SDURation <SyncPulseDuration>

Sets the width of the sync pulse.

Parameters:

<SyncPulseDuration> Range: 100E-9 to 100E-6
 Increment: 100E-9
 *RST: 4.7E-6
 Default unit: s

TRIGger:TV:CUSTom:SCANmode <ScanMode>

Sets the scanning system.

For details, see "Scan" on page 63.

Parameters:

<ScanMode> INTerlaced | PROGressive | SEGmented
 *RST: INTerlaced

15.3.5.6 External Trigger (R&S RTH1002)

TRIGger:EXTernal:LEVel.....	323
TRIGger:EXTernal:SLOPe.....	323

TRIGger:EXTernal:LEVel <Level>

Sets the trigger voltage level.

Parameters:

<Level> Range: -10 to 10
 Increment: 1E-3
 *RST: 0
 Default unit: V

TRIGger:EXTernal:SLOPe <Slope>

Sets the edge direction for the trigger. You can trigger on the rising edge, the falling edge, or riding and falling edges of the external signal.

Parameters:

<Slope> POSitive | NEGative | EITHER
 *RST: POSitive

15.3.5.7 Pattern Trigger (R&S RTH-K19)

See also [Chapter 3.6.7, "Pattern Trigger \(R&S RTH-K19\)"](#), on page 64.

TRIGger:PATtern:STATe[:CHANnel<m>].....	324
TRIGger:PATtern:STATe:COMBination.....	324
TRIGger:PATtern:WIDTh:RANGe.....	325
TRIGger:PATtern:TIMEout[:TIME].....	325
TRIGger:PATtern:WIDTh[:WIDTh].....	325
TRIGger:PATtern:WIDTh:DELTA.....	326
TRIGger:PATtern:WIDTh:MINWidth.....	326
TRIGger:PATtern:WIDTh:MAXWidth.....	326

TRIGger:PATtern:STATe[:CHANnel<m>] <State>

Sets the state of each input channel. The channel is specified by the channel suffix:

The logical combination of the channel states is defined by [TRIGger:STATe:COMBination](#).

Suffix:

<m> 1..4: analog channel 1 to 4
 8..15: digital channels D0 to D7

Parameters:

<State> ONE | ZERO | DONTcare
ONE
 The signal value is above the defined threshold.
ZERO
 The signal value is below the defined threshold.
DONTcare
 The signal state does not matter.
 *RST: DONTcare

TRIGger:PATtern:STATe:COMBination <ChCombination>

Sets the logical combination for all active channels. The required state of each channel is defined by [TRIGger:STATe:CHANnel<m>](#).

Parameters:

<ChCombination> AND | OR
 *RST: AND

TRIGger:PATtern:WIDTh:RANGe <Condition>

Adds additional time limitation to the pattern defined by `TRIGger:PATtern:STATe[:CHANnel<m>]` and `TRIGger:PATtern:STATe:COMBination`.

Parameters:

<Condition>

ANY | TIMEout | LONGer | SHORter | EQUal | NEQual | WITHin | OUTSide

ANY

Triggers on all runts fulfilling the level condition, without time limitation.

Triggers if the signals match the pattern definition for a minimum time, which is specified by `TRIGger:PATtern:TIMEout[:TIME]`.

LONGer | SHORter

Triggers on pulses shorter or longer than a runt width that is defined by `TRIGger:RUNT:WIDTh`.

EQUal | NEQual

Triggers pulses with a width equal or unequal to a given width and an optional tolerance defined by `TRIGger:RUNT:WIDTh` and `Runt Width`

WITHin | OUTSide

Triggers on pulses inside or outside a given range. The range is defined by ..

*RST: LONGer

TRIGger:PATtern:TIMEout[:TIME] <Time>

Sets a minimum time during which the signals match the pattern definition defined by `TRIGger:PATtern:STATe[:CHANnel<m>]` and `TRIGger:PATtern:STATe:COMBination`.

The command is required if `TRIGger:PATtern:WIDTh:RANGe` is set to TIMEout.

Parameters:

<Time>

Range: 100E-12 to 10000

Increment: 100E-9

*RST: 5E-9

Default unit: s

TRIGger:PATtern:WIDTh[:WIDTh] <Duration>

Sets the width for comparison ranges LONGer, SHORter, EQUal and NEQual.

See `TRIGger:PATtern:WIDTh:RANGe` on page 325.

Parameters:

<Duration> Range: 800E-12 to 10000
 Increment: 100E-9
 *RST: 5E-9
 Default unit: s

TRIGger:PATtern:WIDTh:DELTA <Tolerance>

Sets a range Δt to the pattern width that is defined by `TRIGger:PATtern:WIDTh[:WIDTh]`.

Parameters:

<Tolerance> Range: 0 to 5000
 Increment: 500E-12
 *RST: 0
 Default unit: s

TRIGger:PATtern:WIDTh:MINWidth <MinDuration>

Sets the lower time limit of the pattern match for range conditions WITHin and OUT-Side.

Parameters:

<MinDuration> Range: 800E-12 to 10000
 Increment: 100E-9
 *RST: 5E-9
 Default unit: s

TRIGger:PATtern:WIDTh:MAXWidth <MaxDuration>

Sets the upper time limit of the pattern match for range conditions WITHin and OUT-Side.

Parameters:

<MaxDuration> Range: 800E-12 to 10000
 Increment: 100E-9
 *RST: 5E-9
 Default unit: s

15.3.5.8 State Trigger (R&S RTH-K19)

See also [Chapter 3.6.8, "State Trigger \(R&S RTH-K19\)"](#), on page 66.

<code>TRIGger:STATE:CHANnel<m></code>	327
<code>TRIGger:STATE:COMBination</code>	327
<code>TRIGger:STATE:CSource[:VALue]</code>	327
<code>TRIGger:STATE:CSource:EDGE</code>	327

TRIGger:STATe:CHANnel<m> <State>

Sets the state of each input channel. The channel is specified by the channel suffix:

The logical combination of the channel states is defined by [TRIGger:STATe:COMBination](#).

Suffix:

<m> 1..4: analog channel 1 to 4
 8..15: digital channels D0 to D7

Parameters:

<State> ONE | ZERO | DONTcare

ONE

The signal value is above the defined threshold.

ZERO

The signal value is below the defined threshold.

DONTcare

The signal state does not matter.

*RST: DONTcare

TRIGger:STATe:COMBination <ChCombination>

Sets the logical combination for all active channels. The required state of each channel is defined by [TRIGger:PATtern:STATe\[:CHANnel<m>\]](#).

Parameters:

<ChCombination> AND | OR

*RST: AND

TRIGger:STATe:CSource:VALue <Source>

Sets the input channel of the clock signal.

Parameters:

<Source> C1 | C2 | C3 | C4 | D0 | D1 | D2 | D3 | D4 | D5 | D6 | D7

*RST: C1

TRIGger:STATe:CSource:EDGE <Slope>

Sets the edge of the clock at which the instrument checks the signal states.

Parameters:

<Slope> POSitive | NEGative | EITHER

*RST: POSitive

15.3.5.9 Runt Trigger (R&S RTH-K19)

See also [Chapter 3.6.9, "Runt Trigger \(R&S RTH-K19\)"](#), on page 67.

TRIGger:LEVel<m>:RUNT:LOWer..... 328
 TRIGger:LEVel<m>:RUNT:UPPer..... 328
 TRIGger:RUNT:POLarity..... 328
 TRIGger:RUNT:RANGe..... 328
 TRIGger:RUNT:WIDTh..... 329
 TRIGger:RUNT:DELTA..... 329
 TRIGger:RUNT:MINWidth..... 329
 TRIGger:RUNT:MAXWidth..... 329

TRIGger:LEVel<m>:RUNT:LOWer <Level>

TRIGger:LEVel<m>:RUNT:UPPer <Level>

Set the upper and lower levels that limit the runt.

Suffix:

<m> 1..4
 Indicates the trigger source: analog channel 1 to 4

Parameters:

<Level> Range: -10 to 10
 Increment: 1E-3
 *RST: 0
 Default unit: V

TRIGger:RUNT:POLarity <Polarity>

Sets the pulse polarity, that is the direction of the first pulse slope. You can trigger on:

- Positive going pulses. The width is defined from the rising to the falling edge.
- Negative going pulses. The width is defined from the falling to the rising edge.
- Both positive and negative going pulses

Parameters:

<Polarity> POSitive | NEGative | EITHER
 *RST: POSitive

TRIGger:RUNT:RANGe <Condition>

Defines an additional time limit of the runt pulse.

Parameters:

<Condition> ANY | LONGer | SHORter | EQUal | NEQUal | WITHin | OUTSide
ANY
 Triggers on all runts fulfilling the level condition, without time limitation.
LONGer | SHORter
 Defines a minimum time during which the signals match the pattern definition. The minimum time is defined by

EQUal | NEQual

Triggers on pulses equal or not equal a given runt width that is set using `TRIGger:RUNT:WIDTH`. In addition, a tolerance can be set around the specified width using `TRIGger:RUNT:DELTA`.

WITHin | OUTSide

Triggers on pulses inside or outside a given range. The range is set using ... and

*RST: LONGer

TRIGger:RUNT:WIDTH <Duration>

Sets the width for comparison ranges EQUal, UNEQual, SHORter, and LONGer.

See `TRIGger:WIDTH:RANGe`.

Parameters:

<Duration>	Range:	800E-12 to 10000
	Increment:	100E-9
	*RST:	5E-9
	Default unit:	s

TRIGger:RUNT:DELTA <Tolerance>

Sets a range Δt to the specified width, which is defined using `TRIGger:RUNT:WIDTH`.

Parameters:

<Tolerance>	Range:	0 to 5000
	Increment:	500E-12
	*RST:	0
	Default unit:	s

TRIGger:RUNT:MINWidth <MinDuration>

Sets the lower time limit of the runt for comparisons WITHin and OUTSide.

Parameters:

<MinDuration>	Range:	800E-12 to 10000
	Increment:	100E-9
	*RST:	5E-9
	Default unit:	s

TRIGger:RUNT:MAXWidth <MaxDuration>

Sets the upper time limit of the runt for comparisons WITHin and OUTSide.

Parameters:

<MaxDuration> Range: 800E-12 to 10000
 Increment: 100E-9
 *RST: 5E-9
 Default unit: s

15.3.5.10 Slew Rate Trigger (R&S RTH-K19)

See also [Chapter 3.6.10, "Slew Rate Trigger \(R&S RTH-K19\)"](#), on page 69.

TRIGger:LEVel<m>:SLEW:LOWer.....	330
TRIGger:LEVel<m>:SLEW:UPPer.....	330
TRIGger:SLEW:SLOPe.....	330
TRIGger:SLEW:RANGe.....	330
TRIGger:SLEW:RATE.....	331
TRIGger:SLEW:DELTA.....	331
TRIGger:SLEW:MINWidth.....	331
TRIGger:SLEW:MAXWidth.....	331

TRIGger:LEVel<m>:SLEW:LOWer <Level>

TRIGger:LEVel<m>:SLEW:UPPer <Level>

Set the upper and lower voltage thresholds, respectively. The time measurement starts when the signal crosses the first trigger level - the upper or lower level depending on the selected slope - and stops when the signal crosses the second level.

Suffix:

<m> 1..4
 Indicates the trigger source: analog channel 1 to 4

Parameters:

<Level> Range: -10 to 10
 Increment: 1E-3
 *RST: 0
 Default unit: V

TRIGger:SLEW:SLOPe <Slope>

Sets the edge direction for the trigger.

Parameters:

<Slope> POSitive | NEGative | EITHER
 *RST: POSitive

TRIGger:SLEW:RANGe <Condition>

Defines the time limits of the slew rate.

Parameters:

<Condition> LONGer | SHORter | EQUal | NEQual | WITHin | OUTSide

LONGer | SHORter

Triggers on pulses shorter or longer than a runt width that is set using `TRIGger:SLEW:RATE`.

EQUal | NEQual

Triggers on pulses equal or not equal a given runt width that is set using `TRIGger:SLEW:RATE`. In addition, a tolerance can be set around the specified width using `TRIGger:RUNT:DELta`.

WITHin | OUTSide

Triggers on pulses inside or outside a given range. The range is set using ... and

*RST: LONGer

TRIGger:SLEW:RATE <Duration>

Sets the slew rate for comparison ranges EQUal, UNEQual, SHORter, and LONGer.

See `TRIGger:SLEW:RANGe`.

Parameters:

<Duration> Range: 800E-12 to 10000
 Increment: 100E-9
 *RST: 5E-9
 Default unit: s

TRIGger:SLEW:DELta <Tolerance>

Sets a range Δt to the specified slew rate, which is defined using `TRIGger:SLEW:RATE`.

Parameters:

<Tolerance> Range: 0 to 5000
 Increment: 500E-12
 *RST: 0
 Default unit: s

TRIGger:SLEW:MINWidth <MinDuration>

Sets the lower time limit of the transition time for comparisons WITHin and OUTSide.

Parameters:

<MinDuration> Range: 800E-12 to 10000
 Increment: 100E-9
 *RST: 5E-9
 Default unit: s

TRIGger:SLEW:MAXWidth <MaxDuration>

Sets the upper time limit of the transition time for comparisons WITHin and OUTSide.

Parameters:

<MaxDuration> Range: 800E-12 to 10000
 Increment: 100E-9
 *RST: 5E-9
 Default unit: s

15.3.5.11 Data2Clock Trigger (R&S RTH-K19)

See also [Chapter 3.6.11, "Data2Clock Trigger \(R&S RTH-K19\)"](#), on page 70.

TRIGger:DATatoclock:DSource[:VALue].....	332
TRIGger:DATatoclock:CSource[:VALue].....	332
TRIGger:DATatoclock:CSource:EDGE.....	332
TRIGger:DATatoclock:CONDition.....	332
TRIGger:DATatoclock:HTIME.....	333
TRIGger:DATatoclock:STIME.....	333

TRIGger:DATatoclock:DSource[:VALue] <Source>

Selects the input channel of the data signal.

Parameters:

<Source> C1 | C2 | C3 | C4 | D0 | D1 | D2 | D3 | D4 | D5 | D6 | D7
 *RST: C1

TRIGger:DATatoclock:CSource[:VALue] <Source>

Selects the input channel of the clock signal.

Parameters:

<Source> C1 | C2 | C3 | C4 | D0 | D1 | D2 | D3 | D4 | D5 | D6 | D7
 *RST: C1

TRIGger:DATatoclock:CSource:EDGE <Slope>

Sets the edge of the clock signal: rising (POSitive), falling (NEGative), or both edges (EITHer). The time reference point for the setup and hold time is the crossing point of the clock edge and the trigger level.

Parameters:

<Slope> POSitive | NEGative | EITHer
 *RST: POSitive

TRIGger:DATatoclock:CONDition <TrigCondition>

Selects how a violation of the setup and hold time is handled.

Parameters:

<TrigCondition> VIOLation | OK

VIOLation

Triggers on a violation of the setup or hold time

OK

Triggers if setup and hold time keep the limits.

*RST: VIOLation

TRIGger:DATatoclock:HTIME <HoldTime>

Sets the minimum time after the clock edge while the data signal must stay steady.

The hold time can be negative. In this case, the setup time has to be positive. The setup time is defined by [TRIGger:DATatoclock:STIME](#).

Parameters:

<HoldTime> Range: -124E-9 to 124E-9
 Increment: 1E-9
 *RST: 1E-9
 Default unit: s

TRIGger:DATatoclock:STIME <SetupTime>

Sets the minimum time before the clock edge while the data signal must stay steady.

The setup time can be negative. In this case, the hold time has to be positive. The setup time is defined by [TRIGger:DATatoclock:HTIME](#).

Parameters:

<SetupTime> Range: -124E-9 to 124E-9
 Increment: 1E-9
 *RST: 1E-9
 Default unit: s

15.3.5.12 Serial Pattern Trigger (R&S RTH-K19)

[TRIGger:SPATtern:DSource\[:VALue\]](#)..... 333
[TRIGger:SPATtern:CSource\[:VALue\]](#)..... 334
[TRIGger:SPATtern:CSource:EDGE](#)..... 334
[TRIGger:SPATtern:CSource:FIRStedge](#)..... 334
[TRIGger:SPATtern:ORDer](#)..... 334
[TRIGger:SPATtern:PATtern](#)..... 334

TRIGger:SPATtern:DSource[:VALue] <Source>

Selects the input channel of the data signal.

Parameters:

<Source> C1 | C2 | C3 | C4 | D0 | D1 | D2 | D3 | D4 | D5 | D6 | D7
 *RST: C1

TRIGger:SPATtern:CSource:VALue <Source>

Sets the input channel of the clock signal.

Parameters:

<Source> C1 | C2 | C3 | C4 | D0 | D1 | D2 | D3 | D4 | D5 | D6 | D7
*RST: C1

TRIGger:SPATtern:CSource:EDGE <Slope>

Sets the edge at which the data value is sampled.

Parameters:

<Slope> POSitive | NEGative | EITHer
POSitive
Rising edge
NEGative
Falling edge
EITHer
Rising and falling edges are considered (double data rate).
At double data rate, the edge at which the first bit of the pattern is sampled is defined by [TRIGger:SPATtern:CSource:FIRStedge](#).
*RST: POSitive

TRIGger:SPATtern:CSource:FIRStedge <FirstClockEdge>

Sets the edge at which the first bit of the pattern is sampled.

The command is required if [TRIGger:SPATtern:CSource:EDGE](#) is set to `Either` (double data rate).

Parameters:

<FirstClockEdge> POSitive | NEGative | EITHer
*RST: POSitive

TRIGger:SPATtern:ORDer <BitOrder>

Defines if the data words start with MSBF (most significant bit first) or LSBF (least significant bit first).

Parameters:

<BitOrder> LSBF | MSBF
*RST: MSBF

TRIGger:SPATtern:PATtern <Pattern>

Defines the serial pattern to be triggered on.

Parameters:

<Pattern> String that contains the pattern in binary format. The parameter accepts the bit value X (don't care).

Example:

```
TRIGger:SPATtern:PATtern '11001100'
TRIGger:SPATtern:PATtern '110011XX'
```

15.3.5.13 Timeout Trigger (R&S RTH-K19)

TRIGger:TIMEout:RANGe..... 335
 TRIGger:TIMEout:TIME..... 335

TRIGger:TIMEout:RANGe <TimeoutMode>

Selects the relation of the signal level to the trigger level, which is specified with `TRIGger:LEVel<m>:VALue`

Parameters:

<TimeoutMode> HIGH | LOW | EITHer
 *RST: HIGH

TRIGger:TIMEout:TIME <Time>

Sets the time limit for the timeout at which the instrument triggers.

Parameters:

<Time> Range: 100E-12 to 10000
 Increment: 100E-9
 *RST: 5E-9
 Default unit: s

15.3.5.14 Interval Trigger (R&S RTH-K19)

TRIGger:INTerval:SLOPe..... 335
 TRIGger:INTerval:RANGe..... 336
 TRIGger:INTerval:WIDTh..... 336
 TRIGger:INTerval:DELTA..... 336
 TRIGger:INTerval:MINWidth..... 336
 TRIGger:INTerval:MAXWidth..... 337

TRIGger:INTerval:SLOPe <Slope>

Sets the edge direction for the trigger. You can analyze the interval between positive edges or between negative edges.

Parameters:

<Slope> POSitive | NEGative
 *RST: POSitive

TRIGger:INTerval:RANGe <Condition>

Defines how the time range of an interval is defined.

Parameters:

<Condition> LONGer | SHORter | EQUal | NEQual | WITHin | OUTSide

LONGer | SHORter

Triggers on intervals shorter or longer than an interval that is set using `TRIGger:INTerval:WIDTh`.

EQUal | NEQual

Triggers on intervals equal or not equal a given interval width that is set using `TRIGger:INTerval:WIDTh`. In addition, a tolerance can be set around the specified width using `TRIGger:INTerval:DELTA`.

WITHin | OUTSide

Triggers on intervals inside or outside a given range. The range is set using ... and

*RST: LONGer

TRIGger:INTerval:WIDTh <Duration>

Sets the time between two pulses for comparisons EQUal, UNEQual, SHORter, and LONGer.

Parameters:

<Duration> Range: 800E-12 to 10000
Increment: 100E-9
*RST: 5E-9
Default unit: s

TRIGger:INTerval:DELTA <Tolerance>

Sets a range Δt to the specified width, which is defined using `TRIGger:INTerval:WIDTh`. The command is relevant for comparisons EQUal and UNEQual.

Parameters:

<Tolerance> Range: 0 to 5000
Increment: 500E-12
*RST: 0
Default unit: s

TRIGger:INTerval:MINWidth <MinDuration>

Sets the lower time limit of the interval for comparisons WITHin and OUTSide.

Parameters:

<MinDuration> Range: 800E-12 to 10000
 Increment: 100E-9
 *RST: 5E-9
 Default unit: s

TRIGger:INTerval:MAXWidth <MaxDuration>

Sets the upper time limit of the interval for comparisons WITHin and OUTSide.

Parameters:

<MaxDuration> Range: 800E-12 to 10000
 Increment: 100E-9
 *RST: 5E-9
 Default unit: s

15.3.5.15 Window Trigger (R&S RTH-K19)

TRIGger:LEVel<m>:WINDow:LOWer..... 337
 TRIGger:LEVel<m>:WINDow:UPPer..... 337
 TRIGger:WINDow:TIME..... 337
 TRIGger:WINDow:RANGe..... 338
 TRIGger:WINDow:WIDTh..... 338
 TRIGger:WINDow:DELTA..... 338
 TRIGger:WINDow:MINWidth..... 339
 TRIGger:WINDow:MAXWidth..... 339

TRIGger:LEVel<m>:WINDow:LOWer <Level>

TRIGger:LEVel<m>:WINDow:UPPer <Level>

Set the upper and lower voltage thresholds for the window trigger, respectively. The trigger levels are the vertical window limits.

Suffix:

<m> 1..4
 Indicates the trigger source: analog channel 1 to 4

Parameters:

<Level> Range: -10 to 10
 Increment: 1E-3
 *RST: 0
 Default unit: V

TRIGger:WINDow:TIME <Condition>

Selects how the time limit of the window is defined.

Parameters:

<Condition> LONGer | SHORter | EQUal | NEQual | WITHin | OUTSide

LONGer | SHORter

Triggers if the signal crosses the upper or lower level after/
before the time "Width" defined by `TRIGger:WINDow:WIDTh`

EQUal | NEQUal

Triggers if the signal stays inside or outside the vertical window
limits for a time equal/unequal to "Width" "±Tolerance" defined
by `TRIGger:WINDow:WIDTh` and `TRIGger:WINDow:DELTA`.

WITHin

Triggers if the signal stays inside or outside the vertical window
limits for a time \geq "Min Width" AND \leq "Max Width".

OUTSide

Triggers if the signal stays inside or outside the vertical window
limits for a time $<$ "Min Width" OR $>$ "Max Width".

*RST: LONGer

TRIGger:WINDow:RANGe <LevelRangeMode>

Selects how the signal run is compared with the window:

Parameters:

<LevelRangeMode> ENTer | EXIT | WITHin | OUTSide

ENTER | EXIT

Triggers when the signal crosses the upper or lower level and
thus enters/leaves the window made up of these two levels
which are defined by `TRIGger:LEVel<m>:WINDow:UPPer`
and `TRIGger:LEVel<m>:WINDow:LOWer`

WITHin | OUTSide

Triggers if the signal stays between/above the upper and lower
level for a specified time. The time is defined by `TRIGger:`
`WINDow:TIME`

*RST: ENTer

TRIGger:WINDow:WIDTh <Duration>

Sets the width for comparison ranges LONGer, SHORter, EQUal, NEQUal.

See `TRIGger:WINDow:TIME` on page 337.

Parameters:

<Duration> Range: 800E-12 to 10000
 Increment: 100E-9
 *RST: 5E-9
 Default unit: s

TRIGger:WINDow:DELTA <Tolerance>

Sets a range Δt to the specified width, which is defined using `TRIGger:WINDow:`
`WIDTh`.

Parameters:

<Tolerance> Range: 0 to 5000
 Increment: 500E-12
 *RST: 0
 Default unit: s

TRIGger:WINDow:MINWidth <MinDuration>

Sets the lower time limit of the stay inside or outside the window (comparisons WITHin and OUTSide).

Parameters:

<MinDuration> Range: 800E-12 to 10000
 Increment: 100E-9
 *RST: 5E-9
 Default unit: s

TRIGger:WINDow:MAXWidth <MaxDuration>

Sets the upper time limit of the stay inside or outside the window (comparisons WITHin and OUTSide).

Parameters:

<MaxDuration> Range: 800E-12 to 10000
 Increment: 100E-9
 *RST: 5E-9
 Default unit: s

15.4 Waveform Analysis

15.4.1 Zoom

See also [Chapter 4.1, "Zoom"](#), on page 79.

ZOOM:ENABle	339
ZOOM:SCALe	340
ZOOM:POSition	340

ZOOM:ENABle <Enabled>

Enables or disables the zoom.

Parameters:

<Enabled> ON | OFF
 *RST: OFF

ZOOM:SCALE <Scale>

Sets the time scale of the zoomed waveform.

Depending on the recording time not all horizontal scales are available. This is due to the fact that, the zoom is always displaying a complete curve.

Parameters:

<Scale> Range: 1E-12 to 500
 Increment: 1E-12
 *RST: 100E-9
 Default unit: s

ZOOM:POSITION <Position>

Sets the center position of the zoomed area in relation to the trigger point.

Parameters:

<Position> Range: -500 to 500
 Increment: 1E-12
 *RST: 0
 Default unit: s

15.4.2 Automatic Measurements

In remote commands for automatic measurements, the suffix <m> defines the measurement index. You can perform up to four different measurements simultaneously.

- [Measurement Settings](#)..... 340
- [Measurement Results](#)..... 342

15.4.2.1 Measurement Settings

[MEASurement<m>:ENABLE](#)..... 340

[MEASurement<m>:SOURce](#)..... 341

[MEASurement<m>:TYPE](#)..... 341

[MEASurement<m>:AOFF](#)..... 342

[MEASurement<m>:DELay:SLOPe](#)..... 342

MEASurement<m>:ENABLE <State>

Enables or disables the measurement.

Suffix:

<m> 1..4

Parameters:

<State> ON | OFF
 *RST: OFF

MEASurement<m>:SOURce <Source>, [<Source2>]

Defines the waveform to be measured. For delay, phase, and power measurements, 2 sources are required.

The sources can be any active input signal, math or reference waveform. Available source waveforms depend on the measurement type, see [Chapter 4.2.3, "Measurement Types"](#), on page 82.

Suffix:

<m> 1..4

Parameters:

<Source> C1 | C2 | C3 | C4 | M1 | R | D0 | D1 | D2 | D3 | D4 | D5 | D6 | D7

<Source2> C1 | C2 | C3 | C4 | M1 | R | D0 | D1 | D2 | D3 | D4 | D5 | D6 | D7

MEASurement<m>:TYPE <Type>

Selects the measurement type. For a detailed description, see [Chapter 4.2.3, "Measurement Types"](#), on page 82.

Suffix:

<m> 1..4

Parameters:

<Type> PERiod | FREQuency | RTIME | FTIME | PPULse | NPULse | PDCYcle | NDCYcle | DELay | PHASe | MEAN | RMS | CREST | STDDev | MINimum | MAXimum | PKPK | BASelevel | TOPLevel | AMPLitude | AREA | OVRShoot | PREShoot | AC | DC | ACDC | PPCount | NPCount | RECount | FECount | PWRP | PWRS | PWRQ | PWRFactor | VPWM | FPWM | VFPWm

*RST: MINimum

RTIME	Rise time	NPCount	Negative pulse count
FTIME	Fall time	RECount	Rising edge count
PPULse	Positive pulse width	FECount	Falling edge count
NPULse	Negative pulse width	PWRP	Active power
PDCYcle	Positive duty cycle	PWRS	Apparent power
NDCYcle	Negative duty cycle	PWRQ	Reactive power
STDDev	Standard deviation	PWRFactor	Power factor
PKPK	Peak to peak	VPWM	V RMS of PWM signal
OVRShoot	Overshoot	FPWM	Frequency of PWM signal
PREShoot	Preshoot	VFPWm	Ratio of V RMS and frequency of PWM signal
PPCount	Positive pulse count		

MEASurement<m>:AOFF

Disables all active measurements.

Suffix:

<m> 1..4
The suffix is irrelevant.

Usage: Event

MEASurement<m>:DELay:SLOPe <Slope>

Sets the slope for the delay measurement type.

Suffix:

<m> 1..4

Parameters:

<Slope> POSitive | NEGative | EITHer

POSitive

Delay between the first rising edge of each source waveform.

NEGative

Delay between the first falling edge of each source waveform.

EITHer

Delay between the first edge of each source waveform, no matter if it is rising or falling.

*RST: POSitive

15.4.2.2 Measurement Results

MEASurement<m>:RESult:ACTual?

Returns the result of the indicated measurement.

Suffix:

<m> 1..4

Return values:

<Result> Range: -100E+24 to 100E+24
Increment: 100E-12
*RST: 0

Usage: Query only

MEASurement<m>:RESult:LIMit?

Indicates whether the measurement results are inside the measurement range, or outside (clipping).

Suffix:

<m> 1..4

Return values:

<ResultLimit> INSide | OVERflow | UNDErflow | OVUNflow
 *RST: INSide

Usage: Query only

15.4.3 Cursor Measurements

The following commands are required for common R&S RTH cursor measurements. Special commands are available for Spectrum mode, see [Chapter 15.6.2.2, "Cursor Measurements in Spectrum Mode"](#), on page 364.

- [Cursor Settings](#)..... 343
- [Cursor Measurement Results](#)..... 345

15.4.3.1 Cursor Settings

CURSor:STATe	343
CURSor:FUNcTion	343
CURSor:SOURce	343
CURSor:COUPling	344
CURSor:SCPLing	344
CURSor:SCReen	344
CURSor:MEASurement<m>:TYPE	344

CURSor:STATe <State>

Enables or disables the cursor measurement.

Parameters:

<State> ON | OFF
 *RST: OFF

CURSor:FUNcTion <Type>

Defines the type of the cursor measurement.

Parameters:

<Type> VERTical | HORizontal | TRACking | MEASure
 See [Chapter 4.3.2, "Cursor Types and Results"](#), on page 89.
 *RST: VERTical

CURSor:SOURce <Source>

Defines the source on which the cursor measurement is performed. The source setting is not relevant for the vertical cursor type.

Parameters:

<Source> C1 | C2 | C3 | C4 | M1 | D0 | D1 | D2 | D3 | D4 | D5 | D6 | D7
 *RST: C1

CURSor:COUPLing <Coupling>

Couples the cursor lines so that the distance between the two lines remains the same if one cursor is moved.

Parameters:

<Coupling> ON | OFF
 *RST: OFF

CURSor:SCPLing <ScaleCoupling>

If ON, the position of the cursor lines is adjusted if the vertical or horizontal scales are changed. If OFF, the cursor lines remain on their position on the display if the scaling is changed.

Parameters:

<ScaleCoupling> ON | OFF
 *RST: OFF

CURSor:SCReen

Sets the cursors to a default position on the screen.

Usage: Event

CURSor:MEASurement<m>:TYPE <Type>

Sets the automatic measurements to be performed on the source waveform between the cursor lines. The setting is only available if **CURSor:FUNction** is set to **MEASure**.

Suffix:

<m> 1..2
 Defines the measurement index. Two simultaneous cursor measurements can be performed.

Parameters:

<Type> PERiod | FREQuency | RTIME | FTIME | PPULse | NPULse |
 PDCYcle | NDCYcle | MEAN | RMS | CREST | STDDev |
 MINimum | MAXimum | PKPK | BASelevel | TOPLevel |
 AMPLitude | AREA | OVRShoot | PREShoot | AC | DC | ACDC |
 PPCount | NPCount | RECount | FECount | VPWM | FPWM |
 VFPWm
 See **MEASurement<m>:TYPE** on page 341.
 *RST: MINimum

15.4.3.2 Cursor Measurement Results

CURSor:TDELta?	345
CURSor:ITDelta?	345
CURSor:X1Position	345
CURSor:X2Position	345
CURSor:DELTA?	345
CURSor:Y1Position	346
CURSor:Y2Position	346
CURSor:Y1AMplitude?	346
CURSor:Y2AMplitude?	346
CURSor:MEASurement<m>:RESult:ACTual?	346
CURSor:MEASurement<m>:RESult:LIMit?	346

CURSor:TDELta?

Returns the time difference Δ between to vertical cursor lines.

Return values:

<ResultDeltaT> Range: -100E+24 to 100E+24
 *RST: 0

Usage: Query only

CURSor:ITDelta?

Returns the inverse value of time difference between to vertical cursor lines $1/\Delta$.

Return values:

<ResultDeltaTInv> Range: -100E+24 to 100E+24
 Increment: 0
 *RST: 0

Usage: Query only

CURSor:X1Position <UserX1>

CURSor:X2Position <UserX2>

Set the horizontal positions t1 and t2 (time) of the vertical cursor lines.

Parameters:

<UserX1>, <UserX2> Range: -100E+24 to 100E+24
 Increment: 100E-12
 *RST: 0
 Default unit: s

CURSor:DELTA?

Returns the absolute value of the difference between the positions of horizontal cursor lines Δy .

Return values:

<ResultDelta> Range: -100E+24 to 100E+24
 *RST: 0

Usage: Query only

CURSor:Y1Position <UserY1>**CURSor:Y2Position <UserY2>**

Set the vertical positions y1 and y2 of the horizontal cursor lines.

Parameters:

<UserY1>, <UserY2> Range: -100E+24 to 100E+24
 Increment: 100E-6
 *RST: 0
 Default unit: V

CURSor:Y1AMplitude?**CURSor:Y2AMplitude?**

Return the vertical values of the crossing points between the tracking cursors and the source waveform.

Return values:

<ResultAmplitude1> Range: -100E+24 to 100E+24
 <ResultAmplitude2> *RST: 0

Usage: Query only

CURSor:MEASurement<m>:RESult:ACTual?

Returns the result of the indicated cursor measurement.

Suffix:

<m> 1..2
 Defines the measurement index. Two simultaneous cursor measurements can be performed.

Return values:

<Result> Range: -100E+24 to 100E+24
 Increment: 100E-12
 *RST: 0

Usage: Query only

CURSor:MEASurement<m>:RESult:LIMit?

Indicates whether the measurement results are inside the measurement range, or outside (clipping).

Suffix:
 <m> 1..2
 Defines the measurement index. Two simultaneous cursor measurements can be performed.

Return values:
 <ResultLimit> INSide | OVERflow | UNDErflow | OVUNflow
 *RST: INSide

Usage: Query only

15.4.4 Math Waveforms

15.4.4.1 Math Settings

CALCulate:MATH:STATE.....347
 CALCulate:MATH[:EXPRession][:DEFine]..... 347
 CALCulate:MATH:VERTical:SCALe..... 348
 CALCulate:MATH:VERTical:RANGe..... 348
 CALCulate:MATH:VERTical:POSition..... 348

CALCulate:MATH:STATE <State>

Enables or disables the math channel.

Parameters:

<State> ON | OFF

CALCulate:MATH[:EXPRession][:DEFine] <ExprDefinition>

Sets the operation to calculate a math waveform.

Parameters:

<ExprDefinition> String that defines the operation. x is the channel number of source 1, y the channel number of source 2.
 Addition: 'Cx+Cy'
 Subtraction: 'Cx-Cy'
 Multiplication: 'Cx*Cy'
 Inverse: '-Cx'
 Absolute value: 'Abs(Cx)'
 Square: 'Pow(Cx)'

Example:

CALC:MATH:EXPR:DEF 'C1-C2'
 Subtracts the values of CH2 from the values of CH1.
 CALC:MATH:EXPR:DEF 'Pow(C1)'
 Squares the values of CH1.

CALCulate:MATH:VERTical:SCALE <Scale>

Sets the vertical scale (vertical sensitivity) of the math waveform.

Parameters:

<Scale> Scale value, in V/div.

CALCulate:MATH:VERTical:RANGE <Position>

Sets the voltage range across the 8 vertical divisions of the diagram. Use the command alternatively to [CALCulate:MATH:VERTical:SCALE](#).

Parameters:

<Position> Voltage value of the range

CALCulate:MATH:VERTical:POSITION <Position>

Moves the math waveform or down in the diagram.

Parameters:

<Position> Position value, given in divisions.

15.4.5 Reference Waveforms

REFCurve:SOURce	348
REFCurve:UPDate	348
REFCurve:STAtE	349
REFCurve:POSition	349
REFCurve:NAME	349
REFCurve:SAVE	349
REFCurve:OPEN	349
REFCurve:DELeTe	349

REFCurve:SOURce <Source>

Selects the waveform to be taken as reference waveform.

Parameters:

<Source> C1 | C2 | C3 | C4 | M1
*RST: C1

REFCurve:UPDate

Creates the reference waveform from the source waveform.

Usage: Event

REFCurve:STATe <State>

Activates or deactivates the reference waveform.

Parameters:

<State> ON | OFF

REFCurve:POSition <Position>

Sets the vertical position of the reference waveform.

Parameters:

<Position> Default unit: DIV

REFCurve:NAME <Name>

Defines the path, file name and file format of the reference waveform file.

The default path is C : /Users /<user> /Rohde-Schwarz /RTH /ReferenceCurves.

Parameters:

<Name> String

Example:

:REFCurve:NAME 'C :
/Users/user1/Rohde-Schwarz/RTH/ReferenceCurves/reference00'

REFCurve:SAVE

Saves the reference waveform. The target file is specified using [REFCurve:NAME](#).

Usage: Event

REFCurve:OPEN

Loads a stored reference waveform from the specified file. The file is specified using [REFCurve:NAME](#).

Usage: Event

REFCurve:DELEte

Deletes a stored reference waveform file. The file is specified using [REFCurve:NAME](#).

Usage: Event

15.4.6 History (Option R&S RTH-K15)

In `CHANnel:HIStory` commands, the channel suffix is irrelevant, omit it.

See also: [Chapter 4.7, "History \(Option R&S RTH-K15\)"](#), on page 99

CHANnel<m>:HISTory[:STATe].....	350
CHANnel<m>:HISTory:NSEGMents.....	350
CHANnel<m>:HISTory:TPACq.....	350
ACQuire:AVAIlable?.....	350
CHANnel<m>:HISTory:START.....	351
CHANnel<m>:HISTory:STOP.....	351
CHANnel<m>:HISTory:CURRent.....	351
CHANnel<m>:HISTory:PLAY.....	352
CHANnel<m>:HISTory:REPLay.....	352
CHANnel<m>:HISTory:TSABsolute?.....	352
CHANnel<m>:HISTory:TSDate?.....	352
CHANnel<m>:HISTory:TSRelative?.....	353

CHANnel<m>:HISTory[:STATe] <State>

Enables or disables the history function.

Suffix:

<m> Suffix is irrelevant, omit it.

Parameters:

<State> ON | OFF
 *RST: OFF

CHANnel<m>:HISTory:NSEGMents <Depth>

Sets the approximate number of waveforms to be stored.

See also "[Number of Segments](#)" on page 100.

Suffix:

<m> Suffix is irrelevant, omit it.

Parameters:

<Depth> LOW | MEDium | HIGH
 *RST: LOW

CHANnel<m>:HISTory:TPACq <PlayerSpeed>

Defines how fast the history player shows the stored waveforms.

Suffix:

<m> Suffix is irrelevant, omit it.

Parameters:

<PlayerSpeed> AUTO | SLOW | MEDium | FAST
 *RST: AUTO

ACQuire:AVAIlable?

Shows the number of segments that are stored in the history.

Return values:

<AvailableAcqs> Range: 0 to 5000
 Increment: 1
 *RST: 0

Usage: Query only

CHANnel<m>:HISTory:START <StartAcqIdx>

Sets the index of the first (older) history segment that you want to see in the history player. To query the number of available segments, use [ACQUIRE:AVAILABLE?](#).

Suffix:

<m> Suffix is irrelevant, omit it.

Parameters:

<StartAcqIdx> Range: -4999 to 0
 Increment: 1
 *RST: 0

CHANnel<m>:HISTory:STOP <StopAcqIdx>

Sets the index of the last (newer) history segment that you want to see in the history player. To query the number of available segments, use [ACQUIRE:AVAILABLE?](#). The newest segment has always the index "0". Older segments have a negative index.

Suffix:

<m> Suffix is irrelevant, omit it.

Parameters:

<StopAcqIdx> Range: -4999 to 0
 Increment: 1
 *RST: 0

Example:

CHANnel:START -199

CHANnel:STOP -100

The segments 101 (index -100) to 200 (index -199) in the history player.

CHANnel<m>:HISTory:CURRENT <CurrAcqIdx>

Accesses a particular segment in the memory to display it. The query returns the index of the segment that is shown.

To determine the number of stored segments, use [ACQUIRE:AVAILABLE?](#).

Suffix:

<m> Suffix is irrelevant, omit it.

Parameters:

<CurrAcqIdx> History index: the newest segment has the index "0", older segments have a negative index: -(n-1), -1 , 0
n is the number of acquired segments.

Range: 0 to -(n-1)
Increment: 1
*RST: 0

CHANnel<m>:HISTory:PLAY

Starts and stops the playback of the history segments.

Suffix:

<m> Suffix is irrelevant, omit it.

Example:

CHANnel:HISTory:PLAY; *OPC

See also [Chapter B, "Command Sequence and Synchronization"](#), on page 519.

Usage:

Event
Asynchronous command

CHANnel<m>:HISTory:REPLay <AutoRepeat>

If set to ON, the playback of the selected history segments repeats automatically.

Suffix:

<m> Suffix is irrelevant, omit it.

Parameters:

<AutoRepeat> ON | OFF
*RST: OFF

CHANnel<m>:HISTory:TSABsolute?

Returns the absolute daytime of the current segment ([CHANnel<m>:HISTory:CURRent](#)).

Suffix:

<m> Suffix is irrelevant, omit it.

Return values:

<TimeStampAbsTime>String containing the time and unit.

Usage:

Query only

CHANnel<m>:HISTory:TSDate?

Returns the date of the current segment ([CHANnel<m>:HISTory:CURRent](#)).

Suffix:

<m> Suffix is irrelevant, omit it.

Return values:

<TimeStampAbsData>String with date of the current acquisition (absolute time)

Usage: Query only

CHANnel<m>:HISTory:TSRelative?

Returns the relative time of the current segment - the time difference to the newest segment (index = 0).

See also [CHANnel<m>:HISTory:CURRent](#).

Suffix:

<m> Suffix is irrelevant, omit it.

Return values:

<TimeStampRel> String containing the relative time in seconds.

Usage: Query only

15.5 Mask Testing

15.5.1 Mask Definition

The suffix <m> selects the mask channel for which the command is executed. The number of channels depends on the instrument type. The R&S RTH1004 has 5 mask channels, the suffix values are 1 | 2 | 3 | 4 | 5. The R&S RTH1002 has 3 mask channels, the suffix values are 1 | 2 | 5. Suffix 5 is used for the mask on a math waveform.

MASK:CHANnel<m>:STATe	353
MASK:CHANnel<m>:PROPerties:XWIDth	353
MASK:CHANnel<m>:PROPerties:YWIDth	354
MASK:CHANnel<m>:CREatemask	354

MASK:CHANnel<m>:STATe <State>

Turns the selected mask on or off.

Suffix:

<m> 1|2|5 (RTH1002) , 1..5 (RTH1004)

Parameters:

<State> ON | OFF
*RST: OFF

MASK:CHANnel<m>:PROPerties:XWIDth <WidthX>

Changes the width of the selected mask in horizontal direction.

Suffix:
 <m> 1|2|5 (RTH1002) , 1..5 (RTH1004)

Parameters:
 <WidthX> Range: 0 to 10
 Increment: 0.01
 *RST: 0.05
 Default unit: div

MASK:CHANnel<m>:PROPerties:YWIDth <WidthY>
 Changes the width of the selected mask in vertical direction.

Suffix:
 <m> 1|2|5 (RTH1002) , 1..5 (RTH1004)

Parameters:
 <WidthY> Range: 0 to 8
 Increment: 0.01
 *RST: 0.1
 Default unit: div

MASK:CHANnel<m>:CREatemask
 Creates a mask from the envelope waveform of the selected waveform with the defined width in x and y direction.

Suffix:
 <m> 1|2|5 (RTH1002) , 1..5 (RTH1004)

Usage: Event

15.5.2 Mask Test

MASK:ONViolation[:SElection].....	354
MASK:RST.....	355
MASK[:TESTstate]?	355
MASK:CHANnel<m>:RESult:FAIL:PERCentage?	355
MASK:CHANnel<m>:RESult:FAIL[:COUNt]?	355
MASK:CHANnel<m>:RESult:PASS:PERCentage?	356
MASK:CHANnel<m>:RESult:PASS[:COUNt]?	356
MASK:CHANnel<m>:RESult:TOTL[:COUNt]?	356
MASK:ELAPsedtime:TOTal?	356
MASK:ELAPsedtime[:SECS]?	357

MASK:ONViolation[:SElection] <SelectedActions>
 Defines the action to be executed if a violation occurs.

Parameters:

<SelectedActions> NONE | STOP | BEEP | BPSTop
 *RST: NONE

MASK:RST

Sets the counters of passed and failed acquisitions to Zero.

Usage: Event

MASK[:TESTstate]?

Returns the state of the mask test.

Return values:

<TestState> NOMask | IDLE | RUNNing

NOMask

No mask is active and no testing possible.

IDLE

Mask test has been stopped or not yet started.

RUNNing

Test ist running.

*RST: NOMask

Usage: Query only

MASK:CHANnel<m>:RESult:FAIL:PERCentage?

Returns the percentage share of failed acquisitions.

Suffix:

<m> 1|2|5 (RTH1002) , 1..5 (RTH1004)

Return values:

<ResultFailed> Range: 0 to 100
 Increment: 0.1
 *RST: 0
 Default unit: %

Usage: Query only

MASK:CHANnel<m>:RESult:FAIL[:COUNT]?

Returns the number of failed acquisitions.

Suffix:

<m> 1|2|5 (RTH1002) , 1..5 (RTH1004)

Return values:

<ResultFailed> Range: 0 to 0
 Increment: 1
 *RST: 0

Usage: Query only

MASK:CHANnel<m>:RESult:PASS:PERcentage?

Returns the percentage share of passed acquisitions.

Suffix:

<m> 1|2|5 (RTH1002) , 1..5 (RTH1004)

Return values:

<PassedPercentage> Range: 0 to 100
 Increment: 0.1
 *RST: 0
 Default unit: %

Usage: Query only

MASK:CHANnel<m>:RESult:PASS[:COUNT]?

Returns the number of passed acquisitions.

Suffix:

<m> 1|2|5 (RTH1002) , 1..5 (RTH1004)

Return values:

<ResultPassed> Range: 0 to 0
 Increment: 1
 *RST: 0

Usage: Query only

MASK:CHANnel<m>:RESult:TOTL[:COUNT]?

Returns the number of tested acquisitions.

Suffix:

<m> 1|2|5 (RTH1002) , 1..5 (RTH1004)

Return values:

<ResultTotal> Range: 0 to 0
 Increment: 1
 *RST: 0

Usage: Query only

MASK:ELAPsedtime:TOTal? <Day>, <Hour>, <Min>, <Sec>

Returns the test duration.

Query parameters:

- <Day> Test time in days.
- <Hour> Test time in hours.
- <Min> Test time in minutes.
- <Sec> Test time in seconds.

Return values:

- <ZSec> Test time in deciseconds.

Usage: Query only

MASK:ELAPsedtime[:SECS]?

Returns the test duration in seconds.

Return values:

- <Sec> Time in seconds

Usage: Query only

15.6 Spectrum Analysis

- [FFT Mode](#).....357
- [Spectrum Mode \(R&S RTH-K18\)](#).....360
- [Harmonic Mode \(R&S RTH-B34\)](#).....372

15.6.1 FFT Mode

To activate FFT mode, use `OP FFT` (see `OP [:MODE]` on page 303).

SPECTrum:SOURce	357
SPECTrum:FREQuency:BANDwidth[:RESolution][:VALue]	358
SPECTrum:FREQuency:CENTer	358
SPECTrum:FREQuency:HORizontal:SCALe	358
SPECTrum:FREQuency:MAGNitude:SCALe	358
SPECTrum:FREQuency:SAMPle?	359
SPECTrum:FREQuency:SPAN:MODE	359
SPECTrum:FREQuency:SPAN[:VALue]	359
SPECTrum:FREQuency:STARt	359
SPECTrum:FREQuency:STOP	360
SPECTrum:FREQuency:WINDow:FACTor?	360
SPECTrum:FREQuency:WINDow:TYPE	360

SPECTrum:SOURce <Source>

Selects the channel for which the captured data is analyzed in FFT mode.

Parameters:

<Source> C1 | C2 | C3 | C4
 *RST: C1

SPECTrum:FREQUency:BANDwidth[:RESolution][:VALue]

Queries or defines the used resolution bandwidth. The value depends on the [SPECTrum:FREQUency:SPAN:MODE](#) and [CHANnel<m>:BANDwidth](#) parameters.

In FFT mode, this command is query only.

Parameters:

<RBW> Range: 1 to 50E+9
 Increment: 1E+6
 *RST: 500E+3
 Default unit: Hz

SPECTrum:FREQUency:CENTer <HorizCenter>

Queries or defines the used center frequency. The value depends on the [SPECTrum:FREQUency:SPAN:MODE](#) and [CHANnel<m>:BANDwidth](#) parameters.

In FFT mode, this command is query-only.

Parameters:

<HorizCenter> Range: 500 to 500E+6
 Increment: 10
 *RST: 250E+6
 Default unit: Hz

SPECTrum:FREQUency:HORIZontal:SCALE <Scaling>

Defines the scaling method for the frequency (x-)axis of the spectrum display.

Parameters:

<Scaling> LINear | LOGarithmic
 *RST: LINear

SPECTrum:FREQUency:MAGNitude:SCALE <MagnitudeUnit>

Queries or defines the scale unit for the amplitude range (y-axis) in the spectrum display.

In FFT mode, this command is query-only.

Parameters:

<MagnitudeUnit> DBM | DBV | DBA
 *RST: DBM

SPECTrum:FREQUency:SAMPle?

Queries the sample rate with which FFT analysis is performed. This command is only available in FFT mode.

Return values:

<FFTSmpFreq> Range: 1 to 10E+9
 Increment: 10
 *RST: 1
 Default unit: Hz

Usage: Query only

SPECTrum:FREQUency:SPAN:MODE <Mode>

Defines how many values are analyzed by a single FFT, and thus the frequency resolution.

Parameters:

<Mode> NARRow | MAX
 NARRow
 8k values analyzed per FFT; time scale \geq 100 ms/div
 MAX
 64k values analyzed per FFT; time scale \geq 1 us/div
 *RST: MAX

SPECTrum:FREQUency:SPAN[:VALue] <HorizontalSpan>

Queries or defines the used span, that is: how many values are analyzed by a single FFT.

In FFT mode, this command is query-only.

Parameters:

<HorizontalSpan> 8E+6 | 64E+6
 Range: 1000 to 500E+6
 Increment: 10
 *RST: 500E+6
 Default unit: Hz

SPECTrum:FREQUency:START <HorizontalStart>

Queries or defines the start frequency of the used span. The value depends on the [SPECTrum:FREQUency:SPAN:MODE](#) and [CHANnel<m>:BANDwidth](#) parameters.

In FFT mode, this command is query-only.

Parameters:

<HorizontalStart> Range: 0 to 499.999E+6
 Increment: 10
 *RST: 0
 Default unit: Hz

SPECTrum:FREQUency:STOP <HorizontalStop>

Queries or defines the stop frequency of the used span. The value depends on the [SPECTrum:FREQUency:SPAN:MODE](#) and [CHANnel<m>:BANDwidth](#) parameters.

In FFT mode, this command is query-only.

Parameters:

<HorizontalStop> Range: 1000 to 500E+6
 Increment: 10
 *RST: 500E+6
 Default unit: Hz

SPECTrum:FREQUency:WINDow:FACTor?

Queries the window factor used for FFT analysis.

Return values:

<WindowFactor> Range: 0.89 to 3.84
 Increment: 0.1
 *RST: 1.44

Usage: Query only

SPECTrum:FREQUency:WINDow:TYPE <WindowType>

Determines the window function used for FFT analysis. See [Table 6-1](#) for details.

Parameters:

<WindowType> RECTangular | FLATtop | HAMMING | HANN | BLACKman
 *RST: HANN

15.6.2 Spectrum Mode (R&S RTH-K18)

To activate Spectrum mode, use `OP SPEC` (see [OP\[:MODE\]](#) on page 303).

The commands described here are specific to the Spectrum mode and require the R&S RTH-K18 option to be installed.

In addition, the following commands from the FFT mode (integrated in the base unit) are also supported:

- [SPECTrum:SOURce](#) on page 357
- [SPECTrum:FREQUency:HORIZontal:SCALE](#) on page 358
- [SPECTrum:FREQUency:CENTER](#) on page 358

- [SPECTrum:FREQuency:SPAN\[:VALue\]](#) on page 359
- [SPECTrum:FREQuency:WINDow:TYPE](#) on page 360
- [SPECTrum:FREQuency:MAGNitude:SCALE](#) on page 358

Commands specific to the Spectrum mode:

- [Configuring the Measurement](#)..... 361
- [Cursor Measurements in Spectrum Mode](#)..... 364
- [Markers in Spectrum Mode](#)..... 367
- [Exporting Spectrum Analysis Results](#)..... 371

15.6.2.1 Configuring the Measurement

[SPECTrum:MODE?](#)..... 361

[SPECTrum:FREQuency:AVERage:COUNT](#)..... 361

[SPECTrum:FREQuency:BANDwidth\[:RESolution\]:AUTO](#)..... 362

[SPECTrum:FREQuency:BANDwidth\[:RESolution\]:RATio](#)..... 362

[SPECTrum:FREQuency:FULLspan](#)..... 362

[SPECTrum:FREQuency:MAGNitude:REFerence\[:VALue\]](#)..... 362

[SPECTrum:FREQuency:POSition](#)..... 363

[SPECTrum:FREQuency:SCALE](#)..... 363

[SPECTrum:WAVEform:AVERage\[:ENABLE\]](#)..... 363

[SPECTrum:WAVEform:MAXimum\[:ENABLE\]](#)..... 364

[SPECTrum:WAVEform:MINimum\[:ENABLE\]](#)..... 364

[SPECTrum:WAVEform:SPECTrum\[:ENABLE\]](#)..... 364

[SPECTrum:FREQuency:RESet](#)..... 364

SPECTrum:MODE?

Queries the most recently activated spectrum analysis mode.

Return values:

<Mode> FFT | SPECTrum
 *RST: FFT

Usage: Query only

SPECTrum:FREQuency:AVERage:COUNT <NoOfAvs>

Defines the number of measurements to average for the average trace (see [SPECTrum:WAVEform:AVERage\[:ENABLE\]](#) on page 363).

Parameters:

<NoOfAvs> Range: 2 to 1024
 Increment: 2
 *RST: 64

SPECTrum:FREQuency:BANDwidth[:RESolution]:AUTO <State>

If enabled, the optimal resolution bandwidth is determined automatically by the spectrum application according to the frequency span and selected window type.

If disabled, the RBW is set according to the ratio defined by `SPECTrum:FREQuency:BANDwidth[:RESolution]:RATio` on page 362.

Parameters:

<State> ON | OFF
*RST: ON

SPECTrum:FREQuency:BANDwidth[:RESolution]:RATio <RBWRatio>

Determines the resolution of the spectrum, that is: the minimum distance between two distinguishable frequencies.

If you change the span, the RBW is automatically adjusted to the minimum or maximum allowed value, if necessary.

In FFT mode, this command is read-only.

Parameters:

<RBWRatio> R10 | R20 | R50 | R100 | R200 | R500 | R1K
R10
Corresponds to the "RBW:Span Ratio" setting "1:10" in manual operation.
R1K
Corresponds to the "RBW:Span Ratio" setting "1:1000" in manual operation.
*RST: R200

SPECTrum:FREQuency:FULLspan

This command is only available in Spectrum mode. It sets the displayed frequency range to the entire measured span.

Usage: Event

SPECTrum:FREQuency:MAGNitude:REFerence[:VALue] <RefLevel>

Defines the expected maximum input signal level. Signal levels above this value may not be measured correctly. The reference level is also used as the maximum on the y-axis.

This command is only available in Spectrum mode.

Parameters:

<RefLevel> Range: -160 to 160
 Increment: 1
 *RST: 0
 Default unit: dB

SPECTrum:FREQuency:POSition <Frequency>

Configures the position of the spectrum within the vertical diagram grid. Changing this value has the same effect as using the [POS] keys on the instrument.

Note that this command contains the keyword FREQUENCY for compatibility reasons. In effect, it changes the level position in the spectrum diagram.

Parameters:

<Frequency> Defines the number of divisions in the vertical grid that the spectrum is moved up (positive value) or down (negative value).
 Range: -4 to 4
 Increment: 0.5
 *RST: 2
 Default unit: none

SPECTrum:FREQuency:SCALE <VerticalScale>

Configures the scale of the **y**-axis of the spectrum, which is indicated in the channel settings beneath the spectrum diagram. Changing this value has the same effect as using the [RANGE] keys on the instrument.

Note that this command contains the keyword FREQUENCY for compatibility reasons. In effect, it changes the level scaling in the spectrum diagram.

Parameters:

<VerticalScale> Defines the level range displayed in one division of the vertical grid.
 Range: 0.5 to 40
 Increment: 0.1
 *RST: 10
 Default unit: dB

Usage: Asynchronous command

SPECTrum:WAVEform:AVERage[:ENABLE] <State>

Displays the averaged spectrum trace. The number of traces to average is defined using [SPECTrum:FREQuency:AVERage:COUNT](#) on page 361.

Parameters:

<State> ON | OFF
 *RST: OFF

SPECTrum:WAVeform:MAXimum[:ENABLE] <State>

Displays the "Max Hold" spectrum trace.

Parameters:

<State> ON | OFF
 *RST: OFF

SPECTrum:WAVeform:MINimum[:ENABLE] <State>

Displays the "Min Hold" spectrum trace.

Parameters:

<State> ON | OFF
 *RST: OFF

SPECTrum:WAVeform:SPECTrum[:ENABLE] <State>

Displays the clear/write spectrum trace.

Parameters:

<State> ON | OFF
 *RST: ON

SPECTrum:FREQuency:RESet

Clears the results for previous measurements used in statistical evaluation (see [SPECTrum:WAVeform:AVERage\[:ENABLE\]](#), [SPECTrum:WAVeform:MAXimum\[:ENABLE\]](#), [SPECTrum:WAVeform:MINimum\[:ENABLE\]](#) and [SPECTrum:FREQuency:AVERage:COUNT](#) on page 361).

Usage: Event

15.6.2.2 Cursor Measurements in Spectrum Mode

Special cursor commands are available for the Spectrum mode.

SPECTrum:CURSor<m>:STATe	364
SPECTrum:CURSor<m>:SOURce	365
SPECTrum:CURSor<m>:COUPLing	365
SPECTrum:CURSor<m>:SCPLing	365
SPECTrum:CURSor<m>:FREQuency[:VALue]	366
SPECTrum:CURSor<m>:FREQuency:DELTA?	366
SPECTrum:CURSor<m>:LEVel[:VALue]?	366
SPECTrum:CURSor<m>:LEVel:DELTA?	366
SPECTrum:CURSor<m>:SCReen	367

SPECTrum:CURSor<m>:STATe <State>

Enables or disables the spectrum cursor measurement.

Suffix:

<m> 1..2

Parameters:<State> ON | OFF
*RST: OFF**SPECTrum:CURSor<m>:SOURce <TraceSource>**

Selects the trace on which the cursors are placed. Only active traces are available.

See:

- [SPECTrum:WAVEform:MAXimum\[:ENABLE\]](#) on page 364
- [SPECTrum:WAVEform:MINimum\[:ENABLE\]](#) on page 364
- [SPECTrum:WAVEform:SPECTrum\[:ENABLE\]](#) on page 364
- [SPECTrum:WAVEform:AVERage\[:ENABLE\]](#) on page 363

Suffix:

<m> 1..2

Parameters:<TraceSource> SPECTrum | MAXimum | MINimum | AVERage
*RST: SPECTrum**SPECTrum:CURSor<m>:COUPling <State>**

Couples the cursor lines so that the distance between the two lines remains the same if one cursor is moved.

Suffix:<m> 1..2
irrelevant**Parameters:**<State> ON | OFF
*RST: OFF**SPECTrum:CURSor<m>:SCPLing <State>**

If enabled, the position of the cursor lines is adjusted if the vertical or horizontal scales are changed. The cursor lines keep their relative position to the waveform.

If disabled, the cursor lines remain on their position on the display if the scaling is changed.

Suffix:

<m> 1..2

Parameters:<State> ON | OFF
*RST: ON

SPECTrum:CURSor<m>:FREQUency[:VALue] <Frequency>

Queries the frequency at the specified cursor.

Suffix:

<m> 1..2

Parameters:

<Frequency> Range: 0 to 500E+6
Increment: 10
*RST: 100E+6
Default unit: Hz

SPECTrum:CURSor<m>:FREQUency:DELTA?

Queries the difference between the measured frequencies at both cursors.

Suffix:

<m> 1..2
irrelevant

Return values:

<FrequencyDelta> Range: -500E+6 to 500E+6
Increment: 10
*RST: 300E+6
Default unit: Hz

Usage: Query only

SPECTrum:CURSor<m>:LEVel[:VALue]?

Queries the measured level at the specified cursor.

Suffix:

<m> 1..2

Return values:

<Level> Range: -260 to 260
Increment: 1
*RST: 0
Default unit: dB

Usage: Query only

SPECTrum:CURSor<m>:LEVel:DELTA?

Queries the difference in the measured levels for both cursors.

Suffix:

<m> 1..2
irrelevant

Return values:

<LevelDelta> Range: -520 to 520
 Increment: 1
 *RST: 0
 Default unit: dB

Usage: Query only

SPECTrum:CURSor<m>:SCReen

Sets the cursors to a default position on the screen.

Suffix:

<m> 1..2

Usage: Event

15.6.2.3 Markers in Spectrum Mode

Special marker commands are available for the Spectrum mode.

SPECTrum:MARKer[:STATe].....	367
SPECTrum:MARKer:COUNT.....	367
SPECTrum:MARKer:SOURce.....	368
SPECTrum:MARKer:SETup:DISTance.....	368
SPECTrum:MARKer:SETup:EXCURsion.....	368
SPECTrum:MARKer:SETup:MLEVel.....	368
SPECTrum:MARKer:RCOunt?.....	369
SPECTrum:MARKer:RESult<m>:FREQuency[:VALue]?.....	369
SPECTrum:MARKer:RESult<m>:FREQuency:DELTA?.....	369
SPECTrum:MARKer:RESult<m>:LEVel[:VALue]?.....	370
SPECTrum:MARKer:RESult<m>:LEVel:DELTA?.....	370
SPECTrum:MARKer:RMARker:FREQuency?.....	370
SPECTrum:MARKer:RMARker:VALue?.....	371

SPECTrum:MARKer[:STATe] <State>

If enabled, a peak search is performed on the current spectrum results.

Parameters:

<State> ON | OFF
 *RST: OFF

SPECTrum:MARKer:COUNT <NumberOfMarkers>

Defines the number of markers used to indicate peaks in the spectrum results. With 3 active markers, the 3 peak values in the spectrum are indicated.

Parameters:

<NumberOfMarkers> Range: 1 to 15
 Increment: 1
 *RST: 3

SPECTrum:MARKer:SOURce <TraceSource>

Determines the trace used for the peak search.

Parameters:

<TraceSource> SPECTrum | MAXimum | MINimum | AVERage
 *RST: SPECTrum

SPECTrum:MARKer:SETup:DISTance <Distance>

Defines a minimum distance between two frequencies that must be exceeded in order to detect individual peaks.

Parameters:

<Distance> Range: 0 to 500E+6
 Increment: 10
 *RST: 1E+6
 Default unit: Hz

SPECTrum:MARKer:SETup:EXCURsion <Excursion>

Defines a relative threshold, the minimum level value by which the waveform must rise or fall to be considered a peak. To avoid identifying noise peaks, enter a peak excursion value that is higher than the noise levels.

See also "[Peak excursion](#)" on page 128.

Parameters:

<Excursion> Range: 0 to 260
 Increment: 1
 *RST: 10
 Default unit: dB

SPECTrum:MARKer:SETup:MLEVEL <Threshold>

Defines an absolute level threshold as an additional condition for the peak search. Only peaks that exceed the threshold are detected.

Parameters:

<Threshold> Range: -260 to 260
 Increment: 1
 *RST: -40
 Default unit: dB

SPECTrum:MARKer:RCOunt?

Queries the number of markers for which peaks were actually detected during the peak search. Note that the number of markers is restricted by the [SPECTrum:MARKer:COUnT](#) command.

Return values:

<NumberOfResults> Range: 0 to 15
Increment: 1
*RST: 0

Usage: Query only

SPECTrum:MARKer:RESult<m>:FREQUency[:VALue]?

Queries the frequency of the specified marker.

Suffix:

<m> 1 to 15
Number of the marker. The maximum number depends on how many markers were selected and how many peaks were detected (see [SPECTrum:MARKer:RCOunt?](#) on page 369).

Return values:

<Frequency> Range: -10E+9 to 10E+9
Increment: 10
*RST: 10E+6
Default unit: Hz

Usage: Query only

SPECTrum:MARKer:RESult<m>:FREQUency:DELTA?

Queries the frequency difference between the reference marker and the specified marker.

Suffix:

<m> 1 to 15
Marker; maximum depends on active markers and detected peaks (see [SPECTrum:MARKer:COUnT](#) and [SPECTrum:MARKer:RCOunt?](#))

Return values:

<FrequencyDelta> Range: -10E+9 to 10E+9
Increment: 10
*RST: 10E+6
Default unit: Hz

Usage: Query only

SPECTrum:MARKer:RESult<m>:LEVel[:VALue]?

Queries the power level of the specified marker in relation to the reference marker (see [SPECTrum:MARKer:RMARker:VALue?](#) on page 371).

Suffix:

<m> 1 to 15
Number of the marker. The maximum number depends on how many markers were selected and how many peaks were detected (see [SPECTrum:MARKer:RCOUNT?](#) on page 369).

Return values:

<Level> Range: -260 to 260
Increment: 1
*RST: 0
Default unit: dB

Usage: Query only

SPECTrum:MARKer:RESult<m>:LEVel:DELTA?

Queries the level difference between the reference marker and the specified marker.

Suffix:

<m> 1 to 15
Marker; maximum depends on active markers and detected peaks (see [SPECTrum:MARKer:COUNT](#) and [SPECTrum:MARKer:RCOUNT?](#))

Return values:

<LevelDelta> Range: -520 to 520
Increment: 1
*RST: 0
Default unit: dB

Usage: Query only

SPECTrum:MARKer:RMARker:FREQUency?

Queries the frequency of the reference marker. The reference marker is the one with the highest level.

Return values:

<Frequency> Range: -10E+9 to 10E+9
Increment: 10
*RST: 10E+6
Default unit: Hz

Usage: Query only

SPECTrum:MARKer:RMARKer:VALue?

Queries the measured level at the reference marker.

Return values:

<Level> Range: -260 to 260
 Increment: 1
 *RST: 0
 Default unit: dB

Usage: Query only

15.6.2.4 Exporting Spectrum Analysis Results

You can export the spectrum results to a file, similar to waveforms (see [Chapter 15.13](#), "Documenting Results", on page 494).

SPECTrum:EXPort:NAME.....371
 SPECTrum:EXPort:SAVE..... 371
 SPECTrum:EXPort:INCXvalues.....371

SPECTrum:EXPort:NAME <Name>

Defines the file name, file format and path to save the spectrum measurement results.

Parameters:

<Name> String with path and file name with extension .csv or .zip
 (compressed csv).

SPECTrum:EXPort:SAVE

Saves the results of the spectrum measurement to the file specified using `SPECTrum:EXPort:NAME`.

For a description of the file format see [Chapter 6.2.9](#), "Export File Format for Spectrum Results", on page 133.

Example:

```
SPECTrum:EXPort:NAME 'SpectrumResults'
SPECTrum:EXPort:SAVE
SPECTrum:EXPort:NAME?
//Result: /media/SD/Rohde-Schwarz/RTH/Export/SpectrumResults.csv
```

Usage: Event

SPECTrum:EXPort:INCXvalues <State>

Includes the frequency values in the stored results.

Parameters:

<State> ON | OFF
 *RST: ON

15.6.3 Harmonic Mode (R&S RTH-B34)

To activate Harmonic mode, use `OP HARM` (see `OP [:MODE]` on page 303).

The following commands are only available if the Harmonic Analysis option R&S RTH-B34 is installed.

- [Configuring Harmonic Measurements](#).....372
- [Retrieving and Exporting Harmonic Results](#)..... 376

15.6.3.1 Configuring Harmonic Measurements

HARMonic:AVERage	372
HARMonic:CLEar	372
HARMonic:DISPlay:TYPE	372
HARMonic:DISPlay:USER	373
HARMonic:FUNDamental:TYPE	373
HARMonic:FUNDamental:USER	374
HARMonic:FUNDamental:CURRent?	374
HARMonic:LIMits:NAME	374
HARMonic:LIMits:LOAD	375
HARMonic:LIMits:CURRent?	375
HARMonic:LIMits:TYPE	375
HARMonic:SCALE	375
HARMonic:STATistic	376
HARMonic:THDType	376

HARMonic:AVERage <Average>

Determines the number of measurements for which the results are averaged. By default, no averaging is performed.

Parameters:

<Average> OFF | AV2 | AV4 | AV8 | AV16 | AV32
 *RST: OFF

HARMonic:CLEar

Clears the results for previous measurements used in statistical evaluation (see [HARMonic:AVERage](#) on page 372 and [HARMonic:STATistic](#) on page 376).

Usage: Event

HARMonic:DISPlay:TYPE <Selection>

Determines the number of harmonics to be displayed in the bargraph.

Note that this setting only affects the graphical result display; it has no effect on the selection of harmonics for which results are provided during a file export (manually or via remote command). For that purpose, use [HARMonic:LIMits:TYPE](#) on page 375.

Harmonics that were previously eliminated by the `HARMonic:LIMits:TYPE` command cannot be displayed.

Parameters:

<Selection> ALL | EVEN | ODD | ODD3 | ODN3 | USER

ODD3

All harmonics with an odd-numbered order that is a multiple of 3

ODN3

All harmonics with an odd-numbered order that cannot be divided by 3

USER

Selects a user-defined number of harmonics. Define the number of harmonics using the `HARMonic:DISPlay:USER` command.

*RST: ALL

HARMonic:DISPlay:USER <MaxHarmonics>

Determines the maximum number of harmonics to be displayed in the bargraph. This command requires a preceding `HARM:DISP:TYPE USER` command.

Note that this setting only affects the graphical result display; it has no effect on the selection of harmonics for which results are provided during a file export (manually or via remote command). For that purpose, use `HARMonic:LIMits:TYPE` on page 375.

Harmonics that are eliminated by the `HARMonic:LIMits:TYPE` command cannot be displayed.

Parameters:

<MaxHarmonics> Range: 1 to 64
Increment: 1
*RST: 10

Example:

```
HARM:DISP:TYPE USER
HARM:DISP:USER 25
Displays the first 25 harmonics.
```

HARMonic:FUNDamental:TYPE <Fundamental>

Defines the basis of the harmonics measurement. Harmonics are determined as multiples of this frequency.

Parameters:

<Fundamental> F50 | F60 | F400 | USER

F50

50 Hz

F60

60 Hz

F400

400 Hz

USER

User-defined frequency; define the frequency using `HARMonic:FUNDamental:USER`

*RST: F50

Example:

```
HARMonic:FUNDamental:TYPE USER
HARMonic:FUNDamental:USER 123
HARMonic:FUNDamental:CURRent?
//Result: 123
```

HARMonic:FUNDamental:USER <UserFrequency>

Defines the user-defined fundamental frequency if `HARMonic:FUNDamental:TYPE` is set to `USER`.

Parameters:

<UserFrequency> Range: 10 to 1E+6
 Increment: 0.1
 *RST: 50
 Default unit: Hz

Example:

```
HARMonic:FUNDamental:TYPE USER
HARMonic:FUNDamental:USER 123
HARMonic:FUNDamental:CURRent?
//Result: 123
```

HARMonic:FUNDamental:CURRent?

Returns the current fundamental frequency.

Return values:

<CurrFreq> Range: 10 to 1E+6
 Increment: 0.01
 *RST: 50
 Default unit: Hz

Usage: Query only

HARMonic:LIMits:NAME <FileName>**Parameters:**

<FileName> String containing the path and name of the user-defined configuration file to be loaded.

Example:

```
HARM:LIM:NAME
'/media/SD/Rohde-Schwarz/RTH/Harmonic/LimitExample.csv'
HARM:LIM:LOAD
```

HARMonic:LIMits:LOAD

Loads the file selected by [HARMonic:LIMits:NAME](#) on page 374.

Example: HARM:LIM:NAME
 '/media/SD/Rohde-Schwarz/RTH/Harmonic/LimitExample.csv'
 HARM:LIM:LOAD

Usage: Event

HARMonic:LIMits:CURRent?**Return values:**

<Current>

Usage: Query only

HARMonic:LIMits:TYPE <Type>

Defines the type of limit check to be performed.

Parameters:

<Type> NONE | EN50160 | USER

NONE

No limit check is performed.

EN50160

Limits are checked according to the predefined values in the EN50160 standard.

USER

Limits are checked according to the values in a user-defined file (see [HARMonic:LIMits:LOAD](#) on page 375). For details on the required file format see [Chapter 6.3.6.1, "Limit File Format"](#), on page 144.

*RST: NONE

HARMonic:SCALE <Unit>

Switches the scale for the measured harmonic levels between logarithmic (db) and linear (percent). The values are relative to the level measured for the fundamental frequency, or to the level measured for the entire signal, depending on the selected THD type (see [HARMonic:THDType](#) on page 376).

Parameters:

<Unit> PERCent | DB

*RST: DB

HARMonic:STATistic <Type>

By default, the numeric results indicate the currently measured values. Optionally, you can switch to the minimum or maximum values.

Parameters:

<Type> CURRENT | MIN | MAX
 *RST: CURRENT

HARMonic:THDType <THDType>

Parameters:

<THDType> THDF | THDR

THDF

The RMS amplitude (voltage or current) of the harmonics relative to the RMS amplitude of the fundamental component

THDR

The RMS amplitude of the harmonics relative to the RMS amplitude of the input signal

*RST: THDF

15.6.3.2 Retrieving and Exporting Harmonic Results

You can export the harmonic results to a file, similar to waveforms (see [Chapter 15.13, "Documenting Results"](#), on page 494).

HARMonic:EXPort:NAME..... 377
 HARMonic:EXPort:SAVE..... 377
 HARMonic:RESult<m>:CLIPping?..... 377
 HARMonic:RESult<m>:FRQMissing?..... 377
 HARMonic:RESult<m>:FUNDamental?..... 378
 HARMonic:RESult<m>:HARMonics<n>:ABSMagnitude:MAXimum?..... 378
 HARMonic:RESult<m>:HARMonics<n>:ABSMagnitude:MINimum?..... 378
 HARMonic:RESult<m>:HARMonics<n>:ABSMagnitude[:CURRent]?..... 378
 HARMonic:RESult<m>:HARMonics<n>:LIMCheck?..... 378
 HARMonic:RESult<m>:HARMonics<n>:LIMit?..... 379
 HARMonic:RESult<m>:HARMonics<n>:LIMViolation?..... 380
 HARMonic:RESult<m>:HARMonics<n>:PHASe?..... 380
 HARMonic:RESult<m>:HARMonics<n>:RELMagnitude:MAXimum?..... 381
 HARMonic:RESult<m>:HARMonics<n>:RELMagnitude:MINimum?..... 381
 HARMonic:RESult<m>:HARMonics<n>:RELMagnitude[:CURRent]?..... 381
 HARMonic:RESult<m>:HARMonics<n>[:FREQuency]?..... 381
 HARMonic:RESult<m>:LIMViolation?..... 381
 HARMonic:RESult<m>:NOHarmonics?..... 382
 HARMonic:RESult<m>:NOResults?..... 382
 HARMonic:RESult<m>:RMS:MAXimum?..... 382
 HARMonic:RESult<m>:RMS:MINimum?..... 382
 HARMonic:RESult<m>:RMS[:CURRent]?..... 382

HARMonic:RESult<m>:THD:MAXimum?.....	383
HARMonic:RESult<m>:THD:MINimum?.....	383
HARMonic:RESult<m>:THD[:CURRent]?.....	383

HARMonic:EXPort:NAME <Name>

Defines the file name, file format and path to save the harmonic measurement results.

Parameters:

<Name> String with path and file name with extension .csv.

HARMonic:EXPort:SAVE

Saves the results of the harmonic measurement to the file specified using [HARMonic:EXPort:NAME](#).

Example:

```
HARMonic:EXPort:NAME 'HarmonicResults'
HARMonic:EXPort:SAVE
HARMonic:EXPort:NAME?
//Result: /media/SD/Rohde-Schwarz/RTH/Export/HarmonicResults.csv
```

Usage: Event

HARMonic:RESult<m>:CLIPping?

Indicates whether clipping has occurred, that is: the amplitudes exceed the currently defined amplitude range.

Suffix:

<m> 1|2 (RTH1002) , 1..4 (RTH1004)
Input channel

Return values:

<State> ON | OFF

ON
Clipping has occurred, increase the amplitude range (see [CHANnel<m>:RANGe](#) on page 305).

OFF
No clipping has occurred, the current measurement settings are suitable.

*RST: OFF

Usage: Query only

HARMonic:RESult<m>:FRQMissing?

Queries whether the fundamental frequency was detected in the input signal or not. If the specified frequency $\pm 10\%$ is not detected in the signal, the measurement is invalid.

Suffix:
 <m> 1|2 (RTH1002) , 1..4 (RTH1004)

Return values:
 <State> ON | OFF

OFF
 The fundamental frequency was not detected, the measurement is invalid. Define the correct frequency of the input signal.

ON
 The fundamental frequency was detected, the measurement is valid.

*RST: OFF

Usage: Query only

HARMonic:RESult<m>:FUNDamental?

Suffix:
 <m> 1|2 (RTH1002) , 1..4 (RTH1004)

Return values:
 <Frequency> Range: 9 to 1005
 Increment: 10E-6
 *RST: 0
 Default unit: Hz

Usage: Query only

HARMonic:RESult<m>:HARMonics<n>:ABSMagnitude:MAXimum? HARMonic:RESult<m>:HARMonics<n>:ABSMagnitude:MINimum? HARMonic:RESult<m>:HARMonics<n>:ABSMagnitude[:CURRent]?

Returns the currently measured, minimum or maximum power level of the selected harmonic.

Suffix:
 <m> 1|2 (RTH1002) , 1..4 (RTH1004)
 <n> 1..64
 Order of harmonic (possibly restricted, see [HARMonic:RESult<m>:NOHarmonics?](#))

Return values:
 <AbsMagnitude>

Usage: Query only

HARMonic:RESult<m>:HARMonics<n>:LIMCheck?

Queries whether a limit is defined for the specified harmonic (either by the EN50160 standard or by a user-defined configuration file). Only if a limit value is defined, a limit check is performed for the harmonic.

Suffix:	
<m>	1 2 (RTH1002) , 1..4 (RTH1004)
<n>	1..64 Order of harmonic (possibly restricted, see HARMonic:RESult<m>:NOHarmonics?)
Return values:	
<State>	ON OFF ON A limit is specified and a limit check will be performed. OFF No limit is specified, so no limit check will be performed for the harmonic.
Example:	<pre>HARM:LIM:TYPE EN50160 HARM:RES1:HARM2:LIMC? //Result: 1 HARM:RES1:HARM2:LIM? //Result: 2% HARM:RES1:HARM2:LIMV? //Result: 0</pre>
Usage:	Query only

HARMonic:RESult<m>:HARMonics<n>:LIMit?

Queries the limit defined for the specified harmonic.

Note: Only if a limit value is defined, a limit check is performed for the harmonic (see [HARMonic:RESult<m>:HARMonics<n>:LIMCheck?](#) on page 378).

Suffix:	
<m>	1 2 (RTH1002) , 1..4 (RTH1004)
<n>	1..64 Order of harmonic (possibly restricted, see HARMonic:RESult<m>:NOHarmonics?)
Return values:	
<Limit>	percentage
Example:	<pre>HARM:LIM:TYPE EN50160 HARM:RES1:HARM2:LIMC? //Result: 1 HARM:RES1:HARM2:LIM? //Result: 2% HARM:RES1:HARM2:LIMV? //Result: 0</pre>
Usage:	Query only

HARMonic:RESult<m>:HARMonics<n>:LIMViolation?

Queries whether the calculated level for the specified harmonic exceeds the defined.

Note: Only if a limit value is defined, a limit check is performed for the harmonic (see [HARMonic:RESult<m>:HARMonics<n>:LIMCheck?](#) on page 378).

Tip: To query the result of the limit check for the entire signal, use [HARMonic:RESult<m>:LIMViolation?](#) on page 381.

Suffix:

<m> 1|2 (RTH1002) , 1..4 (RTH1004)

<n> 1..64

Order of harmonic (possibly restricted, see [HARMonic:RESult<m>:NOHarmonics?](#))

Return values:

<State> ON | OFF

ON

A limit violation occurred - the limit was exceeded.

OFF

No limit violation occurred.

Example:

```
HARM:LIM:TYPE EN50160
HARM:RES1:HARM2:LIMC?
//Result: 1
//The EN50160 defines a limit of 2% for the
//second order harmonic.
HARM:RES1:HARM2:LIM?
//Result: 2
HARM:RES1:HARM2:LIMV?
//Result: 1
//The calculated value exceeds the defined
// limit for the second harmonic.
HARM:RES1:LIMV?
//Result: 1
//Since the limit check for the second harmonic
// failed, the limit check for the entire
// signal failed.
```

Usage: Query only

HARMonic:RESult<m>:HARMonics<n>:PHASe?

Queries the calculated phase value for the specified harmonic.

Suffix:

<m> 1|2 (RTH1002) , 1..4 (RTH1004)

<n> 1..64

Order of harmonic (possibly restricted, see [HARMonic:RESult<m>:NOHarmonics?](#))

Return values:

<Phase> Default unit: degrees

Usage: Query only

HARMonic:RESult<m>:HARMonics<n>:RELMagnitude:MAXimum?

HARMonic:RESult<m>:HARMonics<n>:RELMagnitude:MINimum?

HARMonic:RESult<m>:HARMonics<n>:RELMagnitude[:CURRent]?

Returns the currently measured, minimum or maximum power level of the selected harmonic, relative to the power level of the fundamental frequency.

Suffix:

<m> 1|2 (RTH1002) , 1..4 (RTH1004)

<n> 1..64
Order of harmonic (possibly restricted, see [HARMonic:RESult<m>:NOHarmonics?](#))

Return values:

<RelMagnitude> Default unit: %

Usage: Query only

HARMonic:RESult<m>:HARMonics<n>[:FREQuency]?

Queries the determined frequency value for the specified harmonic.

Suffix:

<m> 1|2 (RTH1002) , 1..4 (RTH1004)

<n> 1..64
Order of harmonic (possibly restricted, see [HARMonic:RESult<m>:NOHarmonics?](#))

Return values:

<Frequency> Default unit: Hz

Usage: Query only

HARMonic:RESult<m>:LIMViolation?

Queries the result of the limit check for all harmonics. If a single harmonic violates its defined limit, the limit check for the entire signal fails.

Note: Only if a limit value is defined, a limit check is performed for the harmonic (see [HARMonic:RESult<m>:HARMonics<n>:LIMCheck?](#) on page 378).

Tip: To query the result of the limit check for an individual harmonic, use [HARMonic:RESult<m>:HARMonics<n>:LIMViolation?](#) on page 380.

Suffix:
 <m> 1|2 (RTH1002) , 1..4 (RTH1004)

Return values:
 <State> ON | OFF

ON
 A limit violation occurred for at least one harmonic - the limit check for the signal failed.

OFF
 No limit violations occurred. The limit check was passed.

*RST: OFF

Usage: Query only

HARMonic:RESult<m>:NOHarmonics?

Returns the number of harmonics for which results are displayed. The maximum number of 64 harmonics may be restricted due to the [HARMonic:LIMits:TYPE](#) command.

Suffix:
 <m> 1|2 (RTH1002) , 1..4 (RTH1004)

Return values:
 <NoSelection> Range: 1 to 64
 Increment: 1
 *RST: 64

Usage: Query only

HARMonic:RESult<m>:NOResults?

Returns the number of results included in averaging or statistics calculations. Invalid measurements are not included.

Suffix:
 <m> 1|2 (RTH1002) , 1..4 (RTH1004)

Return values:
 <NoResults> Range: 0 to 4000000000
 Increment: 1
 *RST: 0

Usage: Query only

HARMonic:RESult<m>:RMS:MAXimum?

HARMonic:RESult<m>:RMS:MINimum?

HARMonic:RESult<m>:RMS[:CURRent]?

Returns the currently calculated, minimum, or maximum root mean square of the power in the entire signal, that is: for all harmonics and the fundamental frequency.

Suffix:
 <m> 1|2 (RTH1002) , 1..4 (RTH1004)

Return values:
 <RMS> Range: 0 to 100E+3
 Increment: 1E-12
 *RST: 0

Usage: Query only

HARMonic:RESult<m>:THD:MAXimum?
HARMonic:RESult<m>:THD:MINimum?
HARMonic:RESult<m>:THD[:CURRent]?

Returns the currently calculated, minimum, or maximum THD (total harmonic distortion), that is: the RMS of the amplitude of the harmonics. Which value the THD is set in relation to depends on the [HARMonic:THDType](#) command.

Suffix:
 <m> 1|2 (RTH1002) , 1..4 (RTH1004)

Return values:
 <THD> Range: 0 to 1000
 Increment: 0.1
 *RST: 0
 Default unit: %

Example: HARM:THDT THDF
 HARM:RES1:THD?
 Returns the RMS amplitude (voltage or current) of the harmonics relative to the RMS amplitude of the fundamental component.

Usage: Query only

15.7 Digital Multimeter (R&S RTH1002)

- [Activating the Multimeter mode](#).....383
- [Measurement Configuration](#).....384
- [Relative Measurements](#).....391
- [Measurement Control](#).....393
- [Results](#).....395

15.7.1 Activating the Multimeter mode

To activate the DMM, use `OP METer`.

OP[:MODE] <OperationMode>

Sets the operating mode of the instrument.

Parameters:

<OperationMode> YT | XY | MASK | ROLL | METer | FFT | LOGGer | COUNter |
 PROTOcol | HARMonic | SPECTrum
 *RST: YT (scope mode)

15.7.2 Measurement Configuration

The instrument sets most configuration settings automatically. For most measurement types, the measurement range is the only parameter that can be set. For temperature measurements, specific settings are required.

The instrument can adjust the measurement range if autoranging is configured for a measurement. Otherwise, you can set a fixed measurement range.

To set a fixed measurement range, you can use several commands:

- `METer:CONFigure:<function>`
 Configures the specified measurement including the measurement range.
 See [Chapter 15.7.2.1, "METer:CONFigure Commands"](#), on page 384.
- `METer:SENSe:<function>:RANGe:UPPER`
 Sets the measurement range and turns off autoranging.
 See [Chapter 15.7.2.2, "METer:SENSe:<function>:RANGe:UPPER Commands"](#), on page 387.
- `METer:MEASure:<function>`
 Configures the specified measurement including the measurement range, starts the measurement, and returns the result.

To enable autoranging, you can use the following commands:

- `METer:SENSe:<function>:RANGe:AUTO`
 Enables or disables the autoranging. See [Chapter 15.7.2.3, "METer:SENSe:<function>:RANGe:AUTO Commands"](#), on page 389.
- `METer:CONFigure:<function> 'AUTO'`
 See [Chapter 15.7.2.1, "METer:CONFigure Commands"](#), on page 384.

The configuration commands are described in the following chapters:

- [METer:CONFigure Commands](#)..... 384
- [METer:SENSe:<function>:RANGe:UPPER Commands](#)..... 387
- [METer:SENSe:<function>:RANGe:AUTO Commands](#)..... 389
- [AC+DC Current and Voltage Measurements](#)..... 390
- [Temperature Measurements](#)..... 390

15.7.2.1 METer:CONFigure Commands

`METer:CONFigure:<function>` commands set all internal measurement parameters for the specified measurement. For most measurements, it also sets the measurement range.

To set the range to minimum, maximum, or default value, use the following parameters:

- `METer:CONFigure:<function> MIN`

- METer:CONFigure:<function> MAX
- METer:CONFigure:<function> DEF

For some measurements, you can also set the auto range:

METer:CONFigure:<function> 'AUTO'. Note that 'AUTO' is a string parameter. Alternatively, you can use the METer:SENSe:<function>:RANGe:AUTO commands.

The METer:CONFigure:<function> commands are only for configuration. To activate a measurement, use METer:SENSe:FUNction.

METer:CONFigure:VALue? returns the active measurement and range.

To read the result, use METer<m>:READ? or METer<m>:FETCh?.

METer:CONFigure:CONTInuity.....	385
METer:CONFigure:DIODe.....	385
METer:CONFigure:TEMPerature.....	385
METer:CONFigure:CAPacitance.....	385
METer:CONFigure:CURRent:AC.....	386
METer:CONFigure:CURRent:DC.....	386
METer:CONFigure:FREQUency.....	386
METer:CONFigure:RESistance.....	386
METer:CONFigure:VOLTag:e:AC.....	386
METer:CONFigure:VOLTag:e:DC.....	386

METer:CONFigure:CONTInuity
METer:CONFigure:DIODe
METer:CONFigure:TEMPerature

Configures the specified measurement. The instrument sets a fixed range.

Usage: Event

METer:CONFigure:CAPacitance

Sets the internal parameters and configures the range for capacitance measurements.

Parameters:

<Range> <numeric value> | 'AUTO' | MIN | MAX | DEF

<numeric value>

The instrument has fixed measurement ranges: 10 nF|100 nF| 1 µF|10 µF|100 µF|1 mF|10 mF.

You can enter any value between the minimum and maximum value. The instrument uses the next suitable range.

Range: 10 nF to 10 mF

*RST: 10 nF

Usage: Setting only

METer:CONFigure:CURRent:AC**METer:CONFigure:CURRent:DC**

Sets the internal parameters and configures the range for current measurements.

You need an external shunt resistor or I/U converter for current measurement.

Parameters:

<Range> <numeric value> | 'AUTO' | MIN | MAX | DEF

<numeric value>

The instrument has fixed measurement ranges: 1 A|10 A|100 A|1000 A.

You can enter any value between the minimum and maximum value. The instrument uses the next suitable range.

Range: 1 to 1000

*RST: 1

Default unit: A

Usage: Setting only

METer:CONFigure:FREQuency

Configures the frequency measurement and sets voltage autoranging.

To set a fixed voltage range, use [METer:SENSe:FREQuency:VOLTage:RANGE:UPPer](#).

Usage: Event

METer:CONFigure:RESistance

Sets the internal parameters and configures the range for resistance measurements.

Parameters:

<Range> <numeric value> | 'AUTO' | MIN | MAX | DEF

<numeric value>

The instrument has fixed measurement ranges: 1 k Ω |10 k Ω |100 k Ω |1 M Ω |10 M Ω |100 M Ω .

You can enter any value between the minimum and maximum value. The instrument sets the next suitable range.

Range: 1 kOhm to 100 MOhm

*RST: AUTO

Usage: Setting only

METer:CONFigure:VOLTage:AC**METer:CONFigure:VOLTage:DC**

Sets the internal parameters and configures the range for voltage measurements.

Parameters:

<Range> <numeric value> | 'AUTO' | MIN | MAX | DEF

<numeric value>
 The instrument has fixed measurement ranges: 1 V|10 V|100 V| 1000 V.
 You can enter any value between the minimum and maximum value. The instrument uses the next suitable range.

Range: 1 to 1000
 *RST: 1
 Default unit: V

Usage: Setting only

15.7.2.2 METer:SENSe:<function>:RANGe:UPPER Commands

METer:SENSe:<function>:RANGe:UPPER commands set the measurement range and turn off autoranging. You can use these commands in addition to METer:CONFigure commands if you want to change only the range.

METer:SENSe:CAPacitance:RANGe:UPPer.....	387
METer:SENSe:CURRent:AC:RANGe:UPPer.....	387
METer:SENSe:CURRent:DC:RANGe:UPPer.....	387
METer:SENSe:FREQuency:VOLTagE:RANGe:UPPer.....	388
METer:SENSe:REsistance:RANGe:UPPer.....	388
METer:SENSe:VOLTagE:AC:RANGe:UPPer.....	388
METer:SENSe:VOLTagE:DC:RANGe:UPPer.....	388

METer:SENSe:CAPacitance:RANGe:UPPer <Range>

Sets a fixed range for capacitance measurements and turns off auto ranging.

Parameters:

<Range> <numeric value> | MIN | MAX | DEF

<numeric value>
 The instrument has fixed measurement ranges: 10 nF|100 nF| 1 µF|10 µF|100 µF|1 mF|10 mF.
 You can enter any value between the minimum and maximum value. The instrument uses the next suitable range.

Range: 10 nF to 10 mF
 *RST: 10 nF

METer:SENSe:CURRent:AC:RANGe:UPPer <Range>**METer:SENSe:CURRent:DC:RANGe:UPPer <Range>**

Sets a fixed current range and turns off auto ranging.

Parameters:

<Range> <numeric value> | MIN | MAX | DEF

<numeric value>

The instrument has fixed measurement ranges: 1 A|10 A|100 A|1000 A.

You can enter any value between the minimum and maximum value. The instrument uses the next suitable range.

Range: 1 to 1000

*RST: 1

Default unit: A

METer:SENSe:FREQuency:VOLTage:RANGe:UPPer <Range>

Sets a fixed voltage range for frequency measurements and turns off auto ranging.

Parameters:

<Range> <numeric value> | MIN | MAX | DEF

<numeric value>

The instrument has fixed measurement ranges: 1 V|10 V|100 V|1 kV.

You can enter any value between the minimum and maximum value. The instrument uses the next suitable range.

Range: 1 to 1000

*RST: 1

Default unit: V

METer:SENSe:RESistance:RANGe:UPPer <Range>

Sets a fixed range for resistance measurements and turns off auto ranging.

Parameters:

<Range> <numeric value> | MIN | MAX | DEF

<numeric value>

The instrument has fixed measurement ranges: 1 k Ω |10 k Ω |100 k Ω |1 M Ω |10 M Ω |100 M Ω .

You can enter any value between the minimum and maximum value. The instrument sets the next suitable range.

Range: 1 kOhm to 100 MOhm

*RST: 1 kOhm

METer:SENSe:VOLTage:AC:RANGe:UPPer <Range>**METer:SENSe:VOLTage:DC:RANGe:UPPer <Range>**

Sets a fixed voltage range and turns off auto ranging.

Parameters:

<Range>

<numeric value> | MIN | MAX | DEF

<numeric value>

The instrument has fixed measurement ranges: 1 V|10 V|100 V|1000 V.

You can enter any value between the minimum and maximum value. The instrument uses the next suitable range.

Range: 1 to 1000

*RST: 1

Default unit: V

15.7.2.3 METer:SENSe:<function>:RANGe:AUTO Commands

METer:SENSe:<function>:RANGe:AUTO commands turn autoranging on or off. For some measurements, you can also use the METer:CONFigure:<function> command, see [Chapter 15.7.2.1, "METer:CONFigure Commands"](#), on page 384.

METer:SENSe:CAPacitance:RANGe:AUTO.....	389
METer:SENSe:CURRent:AC:RANGe:AUTO.....	389
METer:SENSe:CURRent:DC:RANGe:AUTO.....	389
METer:SENSe:FREQuency:VOLTagE:RANGe:AUTO.....	389
METer:SENSe:RESistance:RANGe:AUTO.....	389
METer:SENSe:VOLTagE:AC:RANGe:AUTO.....	389
METer:SENSe:VOLTagE:DC:RANGe:AUTO.....	389

METer:SENSe:CAPacitance:RANGe:AUTO <State>**METer:SENSe:CURRent:AC:RANGe:AUTO <State>****METer:SENSe:CURRent:DC:RANGe:AUTO <State>****METer:SENSe:FREQuency:VOLTagE:RANGe:AUTO <State>****METer:SENSe:RESistance:RANGe:AUTO <State>****METer:SENSe:VOLTagE:AC:RANGe:AUTO <State>****METer:SENSe:VOLTagE:DC:RANGe:AUTO <State>**

Disables or enables the autoranging for the specified measurement.

The query always returns OFF or ON.

Parameters:

<State>

OFF | ON | ONCE

OFF | ON

0 | 1 are not supported.

ONCE

Performs an immediate autorange and then turns off the autoranging.

Example:

METer:SENSe:VOLTagE:DC:RANGe:AUTO ONCE

METer:SENSe:VOLTagE:DC:RANGe:AUTO?

<-- OFF

15.7.2.4 AC+DC Current and Voltage Measurements

METer<m>:SENSe:CURRent:AC:COUPling.....	390
METer<m>:SENSe:VOLTage:AC:COUPling.....	390

METer<m>:SENSe:CURRent:AC:COUPling <Coupling>

METer<m>:SENSe:VOLTage:AC:COUPling <Coupling>

Enables AC+DC measurements.

Suffix:

<m> 1..4
 R&S RTH1002: always 1, omit the suffix
 R&S RTH1004: Selects the voltmeter.

Parameters:

<CoupVoltageMeas> DCLimit | ACLimit

DCLimit

Enables AC+DC measurement.

ACLimit

Enables AC measurement.

*RST: DCLimit

Example:

Configure and perform AC+DC current measurement with range 100 A:

```
:METer:CONFigure:CURRent:AC 100
:METer:SENSe:FUNCTion 'CURR:AC'
:METer:CONFigure:VALue?
<-- "CURR:AC 100"
:METer:SENSe:CURRent:AC:COUPling DCL
:METer:READ?
<-- 0.035906488794
```

Configure and perform AC voltage measurement with range 10 V:

```
:METer:CONFigure:VAOLTage:AC 10
:METer:SENSe:FUNCTion 'VOLT:AC'
:METer:CONFigure:VALue?
<-- "VOLT:AC 10"
:METer:SENSe:CURRent:AC:COUPling ACL
:METer:READ?
<-- 0.030006488794
```

15.7.2.5 Temperature Measurements

METer:UNIT:TEMPerature.....	390
METer:SENSe:TEMPerature:TRANsductor:RTD:TYPE.....	391

METer:UNIT:TEMPerature <Unit>

Sets the unit for temperature measurements.

Parameters:

<Unit> C | F | K

METer:SENSe:TEMPerature:TRANsductor:RTD:TYPE <Unit>

Sets the adapter type for temperature measurements.

Parameters:

<Unit> PT100 | PT500

15.7.3 Relative Measurements

To perform relative measurements, set the relevant

`METer:SENSe:<function>:NULL:STATe` command to ON. By default, the reference value is 0. Alternatively, you can use `METer<m>:SENSe:RELative:STATe`.

To change the reference value, use the `METer:SENSe:<function>:NULL:VALue` command.

<code>METer:SENSe:CAPacitance:NULL:STATe</code>	391
<code>METer:SENSe:CURRent:AC:NULL:STATe</code>	391
<code>METer:SENSe:CURRent:DC:NULL:STATe</code>	391
<code>METer:SENSe:RESistance:NULL:STATe</code>	391
<code>METer:SENSe:TEMPerature:NULL:STATe</code>	391
<code>METer:SENSe:VOLTage:AC:NULL:STATe</code>	391
<code>METer:SENSe:VOLTage:DC:NULL:STATe</code>	391
<code>METer<m>:SENSe:NULL:STATe</code>	392
<code>METer<m>:SENSe:RELative:STATe</code>	392
<code>METer:SENSe:CAPacitance:NULL:VALue</code>	392
<code>METer:SENSe:CURRent:AC:NULL:VALue</code>	392
<code>METer:SENSe:CURRent:DC:NULL:VALue</code>	392
<code>METer:SENSe:VOLTage:AC:NULL:VALue</code>	392
<code>METer:SENSe:VOLTage:DC:NULL:VALue</code>	392
<code>METer:SENSe:RESistance:NULL:VALue</code>	393
<code>METer:SENSe:TEMPerature:NULL:VALue</code>	393
<code>METer<m>:SENSe:NULL:VALU</code>	393

-
- METer:SENSe:CAPacitance:NULL:STATe <State>**
 - METer:SENSe:CURRent:AC:NULL:STATe <State>**
 - METer:SENSe:CURRent:DC:NULL:STATe <State>**
 - METer:SENSe:RESistance:NULL:STATe <State>**
 - METer:SENSe:TEMPerature:NULL:STATe <State>**
 - METer:SENSe:VOLTage:AC:NULL:STATe <State>**
 - METer:SENSe:VOLTage:DC:NULL:STATe <State>**

Enables or disables the relative measurement. The reference value is defined using the appropriate `METer:SENSe:<function>:NULL:VALue` command.

Parameters:

<State> OFF | ON
 *RST: OFF

METer<m>:SENSe:NULL:STATe <SetRelative>

METer<m>:SENSe:RELative:STATe <SetRelative>

Enables or disables the relative measurement for the currently active measurement type.

Relative measurements are not available for diode, continuity, and frequency measurements.

Suffix:

<m> 1..4
 R&S RTH1002: always 1, omit the suffix
 R&S RTH1004: Selects the voltmeter.

Parameters:

<SetRelative> ON | OFF
 ON = 1, OFF = 0
 *RST: OFF

METer:SENSe:CAPacitance:NULL:VALue <ReferenceValue>

Sets the reference value for capacitance measurements. The measurement result is the difference of the measured sample and the reference value.

The value takes effect if relative measurement is on, see [METer:SENSe:CAPacitance:NULL:STATe](#).

Parameters:

<ReferenceValue> Range: +/- (1.1 * measurement range)
 *RST: 0
 Default unit: F

METer:SENSe:CURRent:AC:NULL:VALue <ReferenceValue>

METer:SENSe:CURRent:DC:NULL:VALue <ReferenceValue>

METer:SENSe:VOLTage:AC:NULL:VALue <ReferenceValue>

METer:SENSe:VOLTage:DC:NULL:VALue <ReferenceValue>

Sets the reference value for relative measurements. The measurement result is the difference of the measured sample and the reference value.

The value takes effect if relative measurement is on, see [METer:SENSe:<function>:NULL:STATe](#).

Parameters:

<ReferenceValue> Range: +/- (1.1 * measurement range)
 *RST: 0
 Default unit: V (VOLTage) | A (CURRent)

METer:SENSe:RESistance:NULL:VALue <ReferenceValue>

Sets the reference value for resistance measurements. The measurement result is the difference of the measured sample and the reference value.

The value takes effect if relative measurement is on, see [METer:SENSe:RESistance:NULL:STATe](#).

Parameters:

<ReferenceValue> Range: +/- (1.1 * measurement range)
 *RST: 0
 Default unit: Ohm

METer:SENSe:TEMPerature:NULL:VALue <ReferenceValue>

Sets the reference value for temperature measurements. The measurement result is the difference of the measured sample and the reference value.

The value takes effect if relative measurement is on, see [METer:SENSe:TEMPerature:NULL:STATe](#).

Parameters:

<ReferenceValue> Range: -200 to 850
 *RST: 0
 Default unit: To define the unit, use [METer:UNIT:TEMPerature](#).

METer<m>:SENSe:NULL:VALU <ReferenceValue>

Sets the reference value for the currently active measurement type.

Relative measurements are not available for diode, continuity, and frequency measurements.

Suffix:

<m> 1..4
 R&S RTH1002: always 1, omit the suffix
 R&S RTH1004: Selects the voltmeter.

Parameters:

<ReferenceValue> Range: +/- (1.1 * measurement range)
 Default unit: Depends on the measurement type

15.7.4 Measurement Control

METer:SENSe:FUNCTion	394
METer:CONFigure:VALue?	394
METer<m>:TRIGger:MODE	394
METer<m>:ABORT	395

METer:SENSe:FUNCTion <MeasType>

Sets the measurement type and activates it. All measurement attributes of the previous function (range, resolution, etc.) are remembered. If you return to the previous function, the measurement attributes are restored.

Changing the measurement type disables scaling, limit testing, histogram, statistics, and trend chart data collection: `CALC:<function>:STAT` is set OFF.

Setting parameters:

<MeasType> 'CAPacitance | CONTinuity | CURRent:AC | CURRent[:DC] |
CURRent:AD | DIODE | FREQuency | RESistance |
TEMPerature | VOLTage:AC | VOLTage[:DC] | VOLTage:AD'
String parameter
*RST: VOLTage [:DC]

Example: `MET:SENS:FUNC "VOLT:AC"`
`MET:CONF:VAL?`
`<--"VOLT:AC 1"`

Usage: Setting only

METer:CONFigure:VALue?

Returns the actual measurement type (short form) and the range.

Return values:

<Configuration> String parameter

Example: `MET:CONF:VAL?`
`<--"VOLT:DC 100"`
The DMM is set to DC voltage measurement and range 100 V.

Usage: Query only

METer<m>:TRIGger:MODE <TriggerMode>

Defines how long the instrument measures. To start the measurement again, use RUN or the appropriate `METer<m>:MEASure:<function>` command.

Suffix:

<m> 1..4
R&S RTH1002: always 1, omit the suffix
R&S RTH1004: Selects the voltmeter.

Parameters:

<TriggerMode> AUTO | SINGle
AUTO
The instrument performs continuous measurements.
SINGle
The instrument performs a single measurement.
*RST: AUTO

METer<m>:ABORt

Stops the running measurement.

Suffix:

<m> 1..4
 R&S RTH1002: always 1, omit the suffix
 R&S RTH1004: Selects the voltmeter.

Usage: Event

15.7.5 Results

- [Reading Values](#)..... 395
- [METer:MEASure Commands](#)..... 396
- [Statistics](#)..... 398

15.7.5.1 Reading Values

After configuration and selection of the active measurement, you can read the result values.

- [METer<m>:INITiate](#)..... 395
- [METer<m>:READ?](#)..... 395
- [METer<m>:FETCh?](#)..... 396

METer<m>:INITiate

Resets the hardware and all statistical values, performs a single measurement and ends in hold mode.

Suffix:

<m> 1..4

Usage: Event

METer<m>:READ?

Starts a new measurement, returns the current measurement result and stays in run mode.

Suffix:

<m> 1..4
 R&S RTH1002: always 1, omit the suffix
 R&S RTH1004: Selects the voltmeter.

Return values:

<Meter result>

Usage: Query only

METer<m>:FETCh?

Returns the currently measured value.

Use this command after `METer<m>:INITiate`.

Suffix:

<m> 1..4
 R&S RTH1002: always 1, omit the suffix
 R&S RTH1004: Selects the voltmeter.

Return values:

<Result> Range: -100E+24 to 100E+24
 Increment: 0
 *RST: 0
 Default unit: V

Example:

```
METer:INITiate
METer:FETCh?
<-- 999.98564109
```

Usage: Query only

15.7.5.2 METer:MEASure Commands

Sending a `METer:MEASure:<function>?` command is the same as sending the `METer:CONFigure:<function>` command followed immediately by a `READ?` command.

<code>METer:MEASure:CONTInuity?</code>	396
<code>METer:MEASure:DIODE?</code>	396
<code>METer:MEASure:FREQuency?</code>	396
<code>METer:MEASure:TEMPerature?</code>	396
<code>METer:MEASure:CAPacitance?</code>	397
<code>METer:MEASure:CURRent:AC?</code>	397
<code>METer:MEASure:CURRent:DC?</code>	397
<code>METer:MEASure:RESistance?</code>	397
<code>METer:MEASure:VOLTag:e:AC?</code>	397
<code>METer:MEASure:VOLTag:e:DC?</code>	397

METer:MEASure:CONTInuity?**METer:MEASure:DIODE?****METer:MEASure:FREQuency?****METer:MEASure:TEMPerature?**

Configures the measurement and returns the result.

Return values:

<Range>

Usage: Query only

METer:MEASure:CAPacitance? [<ExpectedValue>]

Configures the capacitance measurement and returns the result.

Query parameters:

[<ExpectedValue>] <numeric value> | MIN | MAX | DEF | 'AUTO'

Optional parameter, expected measurement result or range. The instrument sets the appropriate measurement range.

See: [METer:CONFigure:CAPacitance](#).

Return values:

<Result> Numeric value

Usage: Query only

METer:MEASure:CURRent:AC? [<ExpectedValue>]**METer:MEASure:CURRent:DC?** [<ExpectedValue>]

Configures the current measurement and returns the result.

Query parameters:

[<ExpectedValue>] <numeric value> | MIN | MAX | DEF | 'AUTO'

Optional parameter, expected measurement result or range. The instrument sets the appropriate measurement range.

See: [METer:CONFigure:CURRent:DC](#).

Return values:

<Result> Numeric value

Example: :METer:MEASure:CURRent:DC? 15
<-- 13.4907681509

Usage: Query only

METer:MEASure:RESistance? [<ExpectedValue>]

Configures the resistance measurement and returns the result.

Query parameters:

[<ExpectedValue>] <numeric value> | MIN | MAX | DEF | 'AUTO'

Optional parameter, expected measurement result or range. The instrument sets the appropriate measurement range.

See: [METer:CONFigure:RESistance](#).

Return values:

<Result> Numeric value

Usage: Query only

METer:MEASure:VOLTag:AC? [<ExpectedValue>]**METer:MEASure:VOLTag:DC?** [<ExpectedValue>]

Configures the voltage measurement and returns the result.

Query parameters:

[<ExpectedValue>] <numeric value> | MIN | MAX | DEF | 'AUTO'

Optional parameter, expected measurement result or range. The instrument sets the appropriate measurement range.

See: [METer:CONFigure:VOLTagE:DC](#).

Return values:

<Result> Numeric value

Example:

```
:METer:MEASure:VOLTagE:DC? 5
```

```
<-- 3.4907681509
```

Usage:

Query only

15.7.5.3 Statistics

Before you can get statistical results, configure the measurement and select the measurement to be performed using [METer:SENSe:FUNctIon](#).

METer<m>:CALCulate:AVERage:AVERage?	398
METer<m>:CALCulate:AVERage:MINimum?	398
METer<m>:CALCulate:AVERage:MAXimum?	399
METer<m>:CALCulate:AVERage:CLEar	399

METer<m>:CALCulate:AVERage:AVERage?

Returns the mean value of the measurement series.

Suffix:

<m> 1..4
 R&S RTH1002: always 1, omit the suffix
 R&S RTH1004: Selects the voltmeter.

Return values:

<Average> Range: -100E+24 to 100E+24
 Increment: 1E-12
 *RST: 0
 Default unit: V

Usage:

Query only

METer<m>:CALCulate:AVERage:MINimum?

Returns the minimum value of the measurement series.

Suffix:

<m> 1..4
 R&S RTH1002: always 1, omit the suffix
 R&S RTH1004: Selects the voltmeter.

Return values:

<Minimum> Range: -100E+24 to 100E+24
 Increment: 1E-12
 *RST: 0
 Default unit: V

Usage: Query only

METer<m>:CALCulate:AVERage:MAXimum?

Returns the maximum value of the measurement series.

Suffix:

<m> 1..4
 R&S RTH1002: always 1, omit the suffix
 R&S RTH1004: Selects the voltmeter.

Return values:

<Maximum> Range: -100E+24 to 100E+24
 Increment: 1E-12
 *RST: 0
 Default unit: V

Usage: Query only

METer<m>:CALCulate:AVERage:CLEar

Deletes all statistical values.

Statistics are also deleted if:

- The measurement function changes (METer:SENSe:FUNction).
- *RST
- SYSTem:PRESet

Suffix:

<m> 1..4
 R&S RTH1002: always 1, omit the suffix
 R&S RTH1004: Selects the voltmeter.

Usage: Event

15.8 Voltmeter (R&S RTH1004)

- [Activating the Voltmeter](#)..... 400
- [Measurement Configuration](#).....400
- [Relative Measurements](#)..... 404
- [Measurement Control](#).....406
- [Results](#).....408

15.8.1 Activating the Voltmeter

METer<m>:SENSe:STATe <State>

Activates the voltmeter measurement.

Suffix:

<m> 1..4
Selects the voltmeter.

Parameters:

<State> ON | OFF
*RST: OFF

15.8.2 Measurement Configuration

The only parameter that can be set is the measurement range. All other settings are automatically adjusted by the instrument.

To set a fixed measurement range, you can use several commands:

- **METer<m>:CONFigure:<function>**
Configures the specified measurement including the measurement range.
See [Chapter 15.8.2.2, "METer<m>:CONFigure Commands"](#), on page 401.
- **METer<m>:SENSe:<function>:RANGe:UPPer**
Sets the measurement range.
See [Chapter 15.8.2.3, "METer<m>:SENSe:<function>:RANGe:UPPER Commands"](#), on page 402.
- **METer<m>:MEASure:<function>**
Configures the specified measurement including the measurement range, starts the measurement, and returns the result.

The configuration commands are described in the following chapters:

- [General Configuration](#).....400
- [METer<m>:CONFigure Commands](#).....401
- [METer<m>:SENSe:<function>:RANGe:UPPER Commands](#).....402
- [AC+DC Current and Voltage Measurements](#).....403

15.8.2.1 General Configuration

METer<m>:SENSe:SOURce <InputChannel>

Selects the input channel to be measured by the specified voltmeter.

Suffix:

<m> 1..4
Selects the voltmeter.

Parameters:

<InputChannel> C1 | C2 | C3 | C4
*RST: C1

METer<m>:SENSe:RANGe <MeterRangeUI>

Sets the measurement range of the input channel that is measured by the meter.

Suffix:

<m> 1..4
Selects the voltmeter.

Parameters:

<MeterRangeUI> Range: The range depends on the selected measurement type. For values, see the appropriate METer:CONFigure:<function> command.

15.8.2.2 METer<m>:CONFigure Commands

METer:CONFigure:<function> commands set all internal measurement parameters for the specified measurement, and also the measurement range.

To set the range to minimum, maximum, or default value, use the following parameters:

- METer<m>:CONFigure:<function> MIN
- METer<m>:CONFigure:<function> MAX
- METer<m>:CONFigure:<function> DEF

The METer<m>:CONFigure:<function> commands are only for configuration. To activate a measurement, use METer<m>:SENSe:FUNCTion on page 406.

METer<m>:CONFigure:VALue? returns the active measurement and range.

To read the result, use METer<m>:READ? or METer<m>:FETCh?.

METer<m>:CONFigure:CURRent:AC.....	401
METer<m>:CONFigure:CURRent:DC.....	401
METer<m>:CONFigure:VOLTag:AC.....	402
METer<m>:CONFigure:VOLTag:DC.....	402

METer<m>:CONFigure:CURRent:AC**METer<m>:CONFigure:CURRent:DC**

Sets the internal parameters and configures the range for current measurements.

You need an external shunt resistor or I/U converter for current measurement.

Suffix:

<m> 1..4
Selects the voltmeter.

Parameters:

<Range> <numeric value> | MIN | MAX | DEF
<numeric value>
 The instrument has fixed measurement ranges: 1 A|10 A|100 A| 1000 A.
 You can enter any value between the minimum and maximum value. The instrument uses the next suitable range.
 Range: 1 to 1000
 *RST: 1
 Default unit: A

Usage: Setting only

METer<m>:CONFigure:VOLTage:AC

METer<m>:CONFigure:VOLTage:DC

Sets the internal parameters and configures the range for voltage measurements.

Suffix:

<m> 1..4
 Selects the voltmeter.

Parameters:

<Range> <numeric value> | MIN | MAX | DEF
<numeric value>
 The instrument has fixed measurement ranges: 1 V|10 V|100 V| 1000 V.
 You can enter any value between the minimum and maximum value. The instrument uses the next suitable range.
 Range: 1 to 1000
 *RST: 1
 Default unit: V

Usage: Setting only

15.8.2.3 METer<m>:SENSe:<function>:RANGe:UPPER Commands

METer<m>:SENSe:<function>:RANGe:UPPER commands set the measurement range. You can use these commands in addition to METer<m>:CONFigure commands if you want to change only the range.

METer<m>:SENSe:CURRent:AC:RANGe:UPPer..... 402
 METer<m>:SENSe:CURRent:DC:RANGe:UPPer..... 402
 METer<m>:SENSe:VOLTage:AC:RANGe:UPPer..... 403
 METer<m>:SENSe:VOLTage:DC:RANGe:UPPer..... 403

METer<m>:SENSe:CURRent:AC:RANGe:UPPer <Range>

METer<m>:SENSe:CURRent:DC:RANGe:UPPer <Range>

Sets a fixed current range.

Suffix:

<m> 1..4
 Selects the voltmeter.

Parameters:

<Range> <numeric value> | MIN | MAX | DEF
<numeric value>
 The instrument has fixed measurement ranges: 1 A|10 A|100 A|1000 A.
 You can enter any value between the minimum and maximum value. The instrument uses the next suitable range.
 Range: 1 to 1000
 *RST: 1
 Default unit: A

METer<m>:SENSe:VOLTage:AC:RANGe:UPPer <Range>

METer<m>:SENSe:VOLTage:DC:RANGe:UPPer <Range>

Sets a fixed voltage range.

Suffix:

<m> 1..4
 Selects the voltmeter.

Parameters:

<Range> <numeric value> | MIN | MAX | DEF
<numeric value>
 The instrument has fixed measurement ranges: 1 V|10 V|100 V|1000 V.
 You can enter any value between the minimum and maximum value. The instrument uses the next suitable range.
 Range: 1 to 1000
 *RST: 1
 Default unit: V

15.8.2.4 AC+DC Current and Voltage Measurements

METer<m>:SENSe:CURREnt:AC:COUPling..... 403

METer<m>:SENSe:VOLTage:AC:COUPling..... 403

METer<m>:SENSe:CURREnt:AC:COUPling <Coupling>

METer<m>:SENSe:VOLTage:AC:COUPling <Coupling>

Enables AC+DC measurements.

Suffix:

<m> 1..4
 R&S RTH1002: always 1, omit the suffix
 R&S RTH1004: Selects the voltmeter.

Parameters:

<CoupleVoltageMeas> DCLimit | ACLimit

DCLimit
 Enables AC+DC measurement.

ACLimit
 Enables AC measurement.

*RST: DCLimit

Example:

Configure and perform AC+DC current measurement with range 100 A:

```
:METer:CONFigure:CURRent:AC 100
:METer:SENSe:FUNcTion 'CURR:AC'
:METer:CONFigure:VALue?
<-- "CURR:AC 100"
:METer:SENSe:CURRent:AC:COUPling DCL
:METer:READ?
<-- 0.035906488794
```

Configure and perform AC voltage measurement with range 10 V:

```
:METer:CONFigure:VAOLTage:AC 10
:METer:SENSe:FUNcTion 'VOLT:AC'
:METer:CONFigure:VALue?
<-- "VOLT:AC 10"
:METer:SENSe:CURRent:AC:COUPling ACL
:METer:READ?
<-- 0.030006488794
```

15.8.3 Relative Measurements

To perform relative measurements, set the relevant METer<m>:SENSe:<function>:NULL:STATe command to ON. By default, the reference value is 0. Alternatively, you can use METer<m>:SENSe:RELative:STATe.

To change the reference value, use the METer<m>:SENSe:<function>:NULL:VALue command.

METer<m>:SENSe:CURRent:AC:NULL:STATe.....	405
METer<m>:SENSe:CURRent:DC:NULL:STATe.....	405
METer<m>:SENSe:VOLTage:AC:NULL:STATe.....	405
METer<m>:SENSe:VOLTage:DC:NULL:STATe.....	405
METer<m>:SENSe:NULL:STATe.....	405
METer<m>:SENSe:RELative:STATe.....	405
METer<m>:SENSe:CURRent:AC:NULL:VALue.....	405
METer<m>:SENSe:CURRent:DC:NULL:VALue.....	405

METer<m>:SENSe:VOLTage:AC:NULL:VALue.....405
 METer<m>:SENSe:VOLTage:DC:NULL:VALue.....405
 METer<m>:SENSe:NULL:VALU.....406

METer<m>:SENSe:CURRent:AC:NULL:STATe <State>
METer<m>:SENSe:CURRent:DC:NULL:STATe <State>
METer<m>:SENSe:VOLTage:AC:NULL:STATe <State>
METer<m>:SENSe:VOLTage:DC:NULL:STATe <State>

Enables or disables the relative measurement. The reference value is defined using
[METer:SENSe:<function>:NULL:VALue](#)

Suffix:

<m> 1..4
 Selects the voltmeter.

Parameters:

<State> OFF | ON
 *RST: OFF

METer<m>:SENSe:NULL:STATe <SetRelative>
METer<m>:SENSe:RELative:STATe <SetRelative>

Enables or disables the relative measurement for the currently active measurement type.

Relative measurements are not available for diode, continuity, and frequency measurements.

Suffix:

<m> 1..4
 R&S RTH1002: always 1, omit the suffix
 R&S RTH1004: Selects the voltmeter.

Parameters:

<SetRelative> ON | OFF
 ON = 1, OFF = 0
 *RST: OFF

METer<m>:SENSe:CURRent:AC:NULL:VALue <ReferenceValue>
METer<m>:SENSe:CURRent:DC:NULL:VALue <ReferenceValue>
METer<m>:SENSe:VOLTage:AC:NULL:VALue <ReferenceValue>
METer<m>:SENSe:VOLTage:DC:NULL:VALue <ReferenceValue>

Sets the reference value for relative measurements. The measurement result is the difference of the measured sample and the reference value.

The value takes effect if relative measurement is on, see [METer<m>:SENSe:VOLTage:DC:NULL:STATe](#).

Suffix:

<m> 1..4
 Selects the voltmeter.

Parameters:

<ReferenceValue> Range: +/- (1.1 * measurement range)
 *RST: 0
 Default unit: V (VOLTage) | A (CURRent)

METer<m>:SENSe:NULL:VALU <ReferenceValue>

Sets the reference value for the currently active measurement type.

Relative measurements are not available for diode, continuity, and frequency measurements.

Suffix:

<m> 1..4
 R&S RTH1002: always 1, omit the suffix
 R&S RTH1004: Selects the voltmeter.

Parameters:

<ReferenceValue> Range: +/- (1.1 * measurement range)
 Default unit: Depends on the measurement type

15.8.4 Measurement Control

METer<m>:SENSe:FUNcTion.....	406
METer<m>:CONFigure:VALue?.....	407
METer<m>:TRIGger:MODE.....	407
METer<m>:ABORt.....	407

METer<m>:SENSe:FUNcTion <MeasType>

Sets the measurement type for the selected meter. All measurement attributes of the previous function (range, resolution, etc.) are remembered. If you return to the previous function, the measurement attributes are restored.

Changing the measurement type disables scaling, limit testing, histogram, statistics, and trend chart data collection: CALC:<function>:STAT is set OFF.

Suffix:

<m> 1..4
 Selects the voltmeter.

Setting parameters:

<MeasType> 'VOLTage:AC | VOLTage[:DC] | VOLTage:AD'
 String parameter
 *RST: VOLTage [:DC]

Example: MET2:SENS:FUNC "VOLT:AC"
 MET2:CONF:VAL?
 <-- "VOLT:AC 1"
 Sets the second voltmeter to AC voltage measurement.

Usage: Setting only

METer<m>:CONFigure:VALue?

Returns the actual measurement type (short form) and the range.

Suffix:
 <m> 1..4
 Selects the voltmeter.

Return values:
 <Configuration> String parameter

Example: MET:CONF:VAL?
 <-- "VOLT:DC 100"
 The first voltmeter is set to DC voltage measurement and range 100 V.

Usage: Query only

METer<m>:TRIGger:MODE <TriggerMode>

Defines how long the instrument measures. To start the measurement again, use RUN or the appropriate METer<m>:MEASure:<function> command.

Suffix:
 <m> 1..4
 R&S RTH1002: always 1, omit the suffix
 R&S RTH1004: Selects the voltmeter.

Parameters:
 <TriggerMode> AUTO | SINGle
AUTO
 The instrument performs continuous measurements.
SINGle
 The instrument performs a single measurement.
 *RST: AUTO

METer<m>:ABORt

Stops the running measurement.

Suffix:
 <m> 1..4
 R&S RTH1002: always 1, omit the suffix
 R&S RTH1004: Selects the voltmeter.

Usage: Event

15.8.5 Results

- [Reading Values](#).....408
- [METer:MEASure Commands](#).....409
- [Statistics](#).....410

15.8.5.1 Reading Values

[METer<m>:INITiate](#).....408

[METer<m>:READ?](#).....408

[METer<m>:FETCh?](#).....408

METer<m>:INITiate

Resets the hardware and all statistical values, performs a single measurement and ends in hold mode.

Suffix:

<m> 1..4

Usage: Event

METer<m>:READ?

Starts a new measurement, returns the current measurement result and stays in run mode.

Suffix:

<m> 1..4
 R&S RTH1002: always 1, omit the suffix
 R&S RTH1004: Selects the voltmeter.

Return values:

<Meter result>

Usage: Query only

METer<m>:FETCh?

Returns the currently measured value.

Use this command after [METer<m>:INITiate](#).

Suffix:

<m> 1..4
 R&S RTH1002: always 1, omit the suffix
 R&S RTH1004: Selects the voltmeter.

Return values:

<Result> Range: -100E+24 to 100E+24
 Increment: 0
 *RST: 0
 Default unit: V

Example:

```
MEter:INITiate
MEter:FETCh?
<-- 999.98564109
```

Usage: Query only

15.8.5.2 METer:MEASure Commands

Sending a `MEter:MEASure:<function>?` command is the same as sending the `MEter:CONFigure:<function>` command followed immediately by a `READ?` command.

<code>MEter<m>:MEASure:CURRent:AC?</code>	409
<code>MEter<m>:MEASure:CURRent:DC?</code>	409
<code>MEter<m>:MEASure:VOLTag:e:AC?</code>	409
<code>MEter<m>:MEASure:VOLTag:e:DC?</code>	409

MEter<m>:MEASure:CURRent:AC? [<ExpectedValue>]

MEter<m>:MEASure:CURRent:DC? [<ExpectedValue>]

Configures the current measurement and returns the result.

Suffix:

<m> 1..4
 Selects the voltmeter.

Query parameters:

[<ExpectedValue>] <numeric value> | MIN | MAX | DEF

Optional parameter, expected measurement result or range. The instrument sets the appropriate measurement range.

See: [MEter<m>:CONFigure:CURRent:DC](#).

Return values:

<Result> Numeric value

Usage: Query only

MEter<m>:MEASure:VOLTag:e:AC? [<ExpectedValue>]

MEter<m>:MEASure:VOLTag:e:DC? [<ExpectedValue>]

Configures the voltage measurement and returns the result.

Suffix:

<m> 1..4
 Selects the voltmeter.

Query parameters:

[<ExpectedValue>] <numeric value> | MIN | MAX | DEF

Optional parameter, expected measurement result or range. The instrument sets the appropriate measurement range.

See: [METer<m>:CONFigure:VOLTagE:DC](#).

Return values:

<Result> Numeric value

Usage: Query only

15.8.5.3 Statistics

Before you can get statistical results, configure the measurement and select the measurement to be performed using [METer<m>:SENSe:FUNcTion](#).

METer<m>:CALCulate:AVERage:AVERage?	410
METer<m>:CALCulate:AVERage:MINimum?	410
METer<m>:CALCulate:AVERage:MAXimum?	411
METer<m>:CALCulate:AVERage:CLEar	411

METer<m>:CALCulate:AVERage:AVERage?

Returns the mean value of the measurement series.

Suffix:

<m> 1..4
R&S RTH1002: always 1, omit the suffix
R&S RTH1004: Selects the voltmeter.

Return values:

<Average> Range: -100E+24 to 100E+24
Increment: 1E-12
*RST: 0
Default unit: V

Usage: Query only

METer<m>:CALCulate:AVERage:MINimum?

Returns the minimum value of the measurement series.

Suffix:

<m> 1..4
R&S RTH1002: always 1, omit the suffix
R&S RTH1004: Selects the voltmeter.

Return values:

<Minimum> Range: -100E+24 to 100E+24
Increment: 1E-12
*RST: 0
Default unit: V

Usage: Query only

METer<m>:CALCulate:AVERage:MAXimum?

Returns the maximum value of the measurement series.

Suffix:

<m> 1..4
 R&S RTH1002: always 1, omit the suffix
 R&S RTH1004: Selects the voltmeter.

Return values:

<Maximum> Range: -100E+24 to 100E+24
 Increment: 1E-12
 *RST: 0
 Default unit: V

Usage: Query only

METer<m>:CALCulate:AVERage:CLEar

Deletes all statistical values.

Statistics are also deleted if:

- The measurement function changes (METer:SENSe:FUNction).
- *RST
- SYSTem:PRESet

Suffix:

<m> 1..4
 R&S RTH1002: always 1, omit the suffix
 R&S RTH1004: Selects the voltmeter.

Usage: Event

15.9 Counter Mode (R&S RTH-K33)

COUNter<m>:ABORt.....	412
COUNter<m>:CALCulate:AVERage:ALL?.....	412
COUNter<m>:CALCulate:AVERage:AVERage?.....	412
COUNter<m>:CALCulate:AVERage:CLEar.....	412
COUNter<m>:CALCulate:AVERage:COUNt:CURRent?.....	413
COUNter<m>:CALCulate:AVERage:MAXimum?.....	413
COUNter<m>:CALCulate:AVERage:MINimum?.....	413
COUNter<m>:CONFigure:FREQuency.....	414
COUNter<m>:CONFigure:VALue?.....	414
COUNter<m>:FETCh?.....	414
COUNter<m>:INITiate.....	415
COUNter<m>:MEASure:FREQuency?.....	415

COUNter<m>:READ?	416
COUNter<m>:SENSe:FUNcTion	416
COUNter<m>:SENSe:RANGe	416
COUNter<m>:SENSe:REFerence:STATe	416
COUNter<m>:SENSe:REFerence:VALue	417
COUNter<m>:SENSe:SOURce	417
COUNter<m>:SENSe:STATe	417
COUNter<m>:SENSe:TRIGger:MODE	417

COUNter<m>:ABORT

Aborts a running measurement and switches to single measurement mode.

Suffix:

<m> 1..2

Usage: Event

COUNter<m>:CALCulate:AVERage:ALL?

Queries the statistical results of all measured counter frequencies since statistics were last restarted.

Suffix:

<m> 1..2

Return values:

<All statistics> Minimum, average, maximum value

Usage: Query only

COUNter<m>:CALCulate:AVERage:AVERage?

Queries the average of all measured counter frequencies since statistics were last restarted.

Suffix:

<m> 1..2

Return values:

<Average> Average measured value
 Range: -100E+24 to 100E+24
 Increment: 1E-12
 *RST: 0
 Default unit: Hz

Usage: Query only

COUNter<m>:CALCulate:AVERage:CLEar

Resets all statistical values.

Suffix:
 <m> 1..2

Usage: Event

COUNter<m>:CALCulate:AVERAge:COUNT:CURRent?

Returns the number of counter frequencies included in the averaging process.

Suffix:
 <m> 1..2

Return values:
 <NumberOfValues> Range: 0 to 4294967295
 Increment: 1
 *RST: 0

Usage: Query only

COUNter<m>:CALCulate:AVERAge:MAXimum?

Queries the maximum of all measured counter frequencies since statistics were last restarted.

Suffix:
 <m> 1..2

Return values:
 <Maximum> Average measured value
 Range: -100E+24 to 100E+24
 Increment: 1E-12
 *RST: 0
 Default unit: Hz

Usage: Query only

COUNter<m>:CALCulate:AVERAge:MINimum?

Queries the minimum of all measured counter frequencies since statistics were last restarted.

Suffix:
 <m> 1..2

Return values:
 <Minimum> Average measured value
 Range: -100E+24 to 100E+24
 Increment: 1E-12
 *RST: 0
 Default unit: Hz

Usage: Query only

COUNter<m>:CONFigure:FREQuency <Range>

This command sets all measurement parameters and trigger parameters to default values for frequency measurements.

Note: this command can be executed at any time, even if the counter is not yet activated. The parameters are stored internally and used when the counter is activated.

Suffix:

<m> 1..2

Parameters:

<Range> <numeric value> | MIN | MAX | DEF

Defines the measurement range of the input signal for the counter. If probes are connected, the MIN | MAX | DEF values are adapted accordingly.

<numeric value>

Power range in V. If necessary, the next higher range is selected.

MIN

100 mV

MAX

300 V

DEF

100 mV

Usage: Setting only

COUNter<m>:CONFigure:VALue?

Returns the current configuration for the counter measurement defined by the most recent `COUNter<m>:CONFigure:FREQuency` or `COUNter<m>:MEASure:FREQuency?` command.

Suffix:

<m> 1..2

Return values:

<ConfigString> String containing the current measurement function (FREQ) and the defined measurement range of the used input channel.

Example:

```
COUN1:CONF:VAL?
//Result: 'FREQ 3V'
```

Usage: Query only

COUNter<m>:FETCh?

Queries the currently measured value.

Suffix:

<m> 1..2

Return values:

<ResultActual> Measured value
 Range: -100E+24 to 100E+24
 Increment: 0
 *RST: 0
 Default unit: Hz

Usage: Query only

COUNter<m>:INITiate

Resets the hardware and all statistical values, performs a single measurement and ends in hold mode.

Suffix:

<m> 1..2

Usage: Event

COUNter<m>:MEASure:FREQuency? <Range>

This command sets all measurement parameters and trigger parameters to default values for frequency measurements, then immediately triggers a counter measurement and returns the result.

This command corresponds to the commands `COUNter<m>:CONFigure:FREQuency` + `COUNter<m>:FETCh?`

Suffix:

<m> 1..2

Parameters:

<Range> <numeric value> | MIN | MAX | DEF

Defines the measurement range of the input signal for the counter. If probes are connected, the MIN | MAX | DEF values are adapted accordingly.

<numeric value>

Power range in V. If necessary, the next higher range is selected.

MIN

100 mV

MAX

300 V

DEF

100 mV

Return values:

<Counter result> Measured frequency

Usage: Query only

COUNter<m>:READ?

Starts a new measurement, returns the current measurement result and stays in run mode.

Suffix:

<m> 1..2

Return values:

<Counter result> Measured frequency

Usage: Query only

COUNter<m>:SENSe:FUNCTion [<Function>]

Selects the input channel for the counter.

Suffix:

<m> 1..2

Parameters:

<Function> 'FREQ 1' | 'FREQ 2' | 'FREQ 3' | 'FREQ 4'
Depends on available channels.

COUNter<m>:SENSe:RANGe <MeterRangeUI>

This command defines the measurement range.

Suffix:

<m> 1..2

Parameters:

<MeterRangeUI> Range: 0.1 to 300
Increment: 0.1
*RST: 0.1

COUNter<m>:SENSe:REFerence:STATe <ReferenceSource>

Selects the reference to be used for the counter.

Suffix:

<m> 1..2

Parameters:

<ReferenceSource> INTernal | EXTernal

EXTernal

The measured value of counter 2 is used as a reference. Specify the nominal reference frequency for counter 2 using [COUNter<m>:SENSe:REFerence:VALue](#).

INTernal

An internal reference is used to determine the counter frequency.

*RST: INTernal

COUNter<m>:SENSe:REFerence:VALue <RefFreq>

Defines the nominal frequency value to be used as a reference for counter 2.

Suffix:

<m> 1..2

Parameters:

<RefFreq> Range: 10 to 500E+6
 Increment: 1
 *RST: 10E+6
 Default unit: Hz

COUNter<m>:SENSe:SOURce <InputChannel>

Selects the channel used for input for the selected counter.

Suffix:

<m> 1..2

Parameters:

<InputChannel> C1 | C2 | C3 | C4
 *RST: C1

COUNter<m>:SENSe:STATe <State>

Activates or deactivates the counter.

Suffix:

<m> 1..2

Parameters:

<State> ON | OFF
 *RST: OFF

COUNter<m>:SENSe:TRIGger:MODE <TriggerMode>

Determines the measurement mode.

Suffix:

<m> 1..2

Parameters:

<TriggerMode> AUTO | SINGLE

AUTO

Continuous measurement; the most recent value is preserved and displayed, while the oldest value are overwritten

SINGle

Single measurement; the continuous measurement is stopped and the most recent value is preserved.

*RST: AUTO

15.10 Data Logging

- [Logger Settings](#)..... 418
- [Scaling](#)..... 421
- [Cursor in Logger Mode](#)..... 423
- [Zoom in Logger mode](#)..... 425
- [Logger Statistics](#) 426
- [Logger Records](#)..... 429

15.10.1 Logger Settings

- [LOGGer:SOURce](#)..... 418
- [LOGGer:TIMEbase:SRATe](#)..... 418
- [LOGGer:TIMEbase:SCALE](#)..... 419
- [LOGGer:SLOT:CURRent](#)..... 419
- [LOGGer:SLOT:SLOT<m>:NAME](#)..... 419
- [LOGGer:SLOT:SLOT<m>:HASData?](#)..... 419
- [LOGGer:SLOT:SLOT<m>:START?](#)..... 420
- [LOGGer:SLOT:LOAD](#)..... 420
- [LOGGer:SLOT:CLEar](#)..... 420
- [LOGGer:ACLR](#)..... 420

LOGGer:SOURce <Source>

Sets the logger source.

Before you can change the logger source, stop the measurement.

Parameters:

<Source> SCOPE | METer | COUNter

SCOPE: an active automatic measurement is required.

METer | COUNter: The selected measurement must be active, but not running.

LOGGer:TIMEbase:SRATe <NextSampleRate>

Sets the number of samples per second.

Parameters:

<NextSampleRate> SA1 | SA2 | SA5 | SA10

*RST: SA1

LOGGer:TIMEbase:SCALE <NextHorizScale>

Selects the horizontal scale of the logged data.

Parameters:

<NextHorizScale> AUTO | S1 | S2 | S4 | S5 | S10 | S20 | S40 | M1 | M2 | M4 | M5 |
 M10 | M20 | M40 | H1 | H2 | H4 | H5 | H10 | H20 | D1 | D2 | D4
S1 | S2 | S4 | S5 | S10 | S20 | S40
 Seconds per division
M1 | M2 | M4 | M5 | M10 | M20 | M40
 Minutes per division
H1 | H2 | H4 | H5 | H10 | H20
 Hours per division
D1 | D2 | D4
 Days per division
 *RST: AUTO

LOGGer:SLOT:CURRent <SelectedSlot>

Selects one of the 10 memory slots to store the data during the logging. It is possible to change the slot during recording. This command shows the slot number that is selected in the menu.

Parameters:

<SelectedSlot> SLOT1 | SLOT2 | SLOT3 | SLOT4 | SLOT5 | SLOT6 | SLOT7 |
 SLOT8 | SLOT9 | SLOT10
 *RST: SLOT1

LOGGer:SLOT:SLOT<m>:NAME <Name>

Sets an optional slot name to describe the logged data.

Suffix:

<m> 1..10
 Slot number

Parameters:

<Name> String parameter, name of the slot. The maximum length of the name is 20 characters.

Firmware/Software: FW 1.60 and higher

LOGGer:SLOT:SLOT<m>:HASData?

Queries if the slot has data.

Suffix:

<m> 1..10
 Slot number

Return values:

<HasData> 1 | 0
 1: data available
 0: slot is empty
 *RST: 0

Usage: Query only

Firmware/Software: FW 1.60 and higher

LOGGer:SLOT:SLOT<m>:START? <Year>, <Month>, <Day>, <Hour>, <Min>, <Sec>

Returns the start time of the logger record. If the slot is empty, the command returns an error.

Suffix:

<m> 1..10
 Slot number

Query parameters:

<Year>, <Month>, <Day>, <Hour>, <Min>, <Sec>, <ZSec>
 Date and time of the slot start

Usage: Query only

Firmware/Software: FW 1.60 and higher

LOGGer:SLOT:LOAD

Loads the logger record of a slot, and activates the slot. The slot is defined using [LOGGer:SLOT:CURRent](#).

Usage: Event

LOGGer:SLOT:CLEAr

Deletes the log data of a slot. The slot is defined using [LOGGer:SLOT:CURRent](#).

Only possible while logging is stopped.

Usage: Event

LOGGer:ACLR

Deletes the log data of all slots. Only possible while logging is stopped.

Usage: Event

15.10.2 Scaling

LOGGer:AUToset.....	421
LOGGer:MEASurement<m>:VERTical:AUTO.....	421
LOGGer:MEASurement<m>:VERTical:UPPer.....	421
LOGGer:MEASurement<m>:VERTical:LOWer.....	421
LOGGer:MEASurement<m>:VERTical:DEViation.....	422
LOGGer:MEASurement<m>:VERTical:MEAN.....	422

LOGGer:AUToset

Sets all logger channels to automatic scaling.

Usage: Event

Firmware/Software: FW 1.60 and higher

LOGGer:MEASurement<m>:VERTical:AUTO [<State>]

Enables or disables the vertical auto scaling for the specified logger channel.

Using the command without parameter performs auto scaling once, without changing the state.

Suffix:

<m> 1..4
Logger channel

Parameters:

<State> ON | OFF
*RST: ON

Example:

```
LOGGer:MEASurement1:VERTical:AUTO 0 //sets manual scaling for ch1
LOGGer:MEASurement1:VERTical:AUTO //autoscales logger channel 1
LOGGer:MEASurement1:VERTical:AUTO?
<-- 0 //state is unchanged (off)
```

Firmware/Software: FW 1.60 and higher

LOGGer:MEASurement<m>:VERTical:UPPer <Upper>, [<Lower>]

LOGGer:MEASurement<m>:VERTical:LOWer <Lower>, [<Upper>]

Set the upper and lower range limits for the specified logger channel. The values must differ. You can set both values using only one of the commands (see examples). The query returns the mandatory parameter.

The commands disable the vertical auto scaling.

Suffix:

<m> 1..4
Logger channel

Parameters:

<Lower> Lower range limit

Setting parameters:

<Upper> Upper range limit

Example:

Set the lower value to -1 and the upper value to +1 using both commands:

```
LOGGer:MEASurement1:VERTical:LOWer -1
LOGGer:MEASurement1:VERTical:UPPer +1
```

Example:

Set the lower value to -1 and the upper value to +1 using one command:

```
LOGGer:MEASurement1:VERTical:LOWer -1, +1
//or
LOGGer:MEASurement1:VERTical:UPPer +1, -1
```

Firmware/Software: FW 1.60 and higher

LOGGer:MEASurement<m>:VERTical:DEVIation <Deviation>

Sets the distance between the lower range and the mean value and between the upper range and the mean value.

The command disables the vertical auto scaling.

See also: [LOGGer:MEASurement<m>:VERTical:MEAN](#).

Suffix:

<m> 1..4
Logger channel

Parameters:

<Deviation> Absolute difference between mean value and upper/lower range
Range: 1E-15 to 100E+24
Increment: 1
*RST: 0.707

Firmware/Software: FW 1.60 and higher

LOGGer:MEASurement<m>:VERTical:MEAN <Mean>, [<Deviation>]

Sets the mean value of the scaling range. In addition, you can set the deviation. The query returns the mean value.

The command disables the vertical auto scaling.

Use this command if you want to define the range based on the mean value and the standard deviation, see [LOGGer:MEASurement<m>:RESult:MEAN?](#) and [LOGGer:MEASurement<m>:RESult:STDDev?](#) on page 428.

Suffix:

<m> 1..4
Logger channel

Parameters:

<Mean> Middle value between the upper and lower scaling value.

Setting parameters:

<Deviation> Absolute difference between mean value and upper/lower scaling value

Example:

```
LOGGer:MEASurement1:VERTical:MEAN 10, 1
```

Sets the mean value to 10, and the deviation to 1. Thus, the upper range is $10 + 1 = 11$, and the lower range is $10 - 1 = 9$.

Firmware/Software: FW 1.60 and higher

15.10.3 Cursor in Logger Mode

15.10.3.1 Cursor Settings

LOGGer:CURSor[:STATe].....	423
LOGGer:CURSor:TYPE.....	423
LOGGer:CURSor:SCPLing.....	423
LOGGer:CURSor:COUPLing.....	424
LOGGer:CURSor:SCReen.....	424

LOGGer:CURSor[:STATe] <Enabled>

Enables or disables the logger cursor measurement.

Parameters:

<Enabled> ON | OFF
*RST: OFF

LOGGer:CURSor:TYPE <Value>

If data logging is running for more than 2 days and 7 hours, the logger compresses 4 logging values into a minimum, average and maximum value. The command defines which of these values are measured at the cursor position.

For logging periods shorter than 2 days and 7 hours, the command is not relevant.

Parameters:

<Value> MINimum | AVERage | MAXimum
*RST: AVERage

LOGGer:CURSor:SCPLing <TrackScaling>

If ON, the position of the cursor lines is adjusted when the horizontal scale is changed. If OFF, the cursor lines remain on their position on the display when the scaling is changed.

Parameters:
 <TrackScaling> ON | OFF
 *RST: OFF

LOGGer:CURSor:COUPling <Coupling>

Couples the cursor lines so that the distance between the two lines remains the same when one cursor is moved.

Parameters:
 <Coupling> ON | OFF
 *RST: OFF

LOGGer:CURSor:SCReen

Sets the cursors to a default position on the screen.

Usage: Event

15.10.3.2 Cursor Results

LOGGer:CURSor<m>:RESult<n>[:AMPLitude]?.....424
 LOGGer:CURSor:RESult<n>:DELTA?..... 424
 LOGGer:CURSor<m>:POSition.....425
 LOGGer:CURSor:TDELta?..... 425

LOGGer:CURSor<m>:RESult<n>[:AMPLitude]?

Returns the measured value at the specified cursor line (y1 and y2 on the result display).

Suffix:
 <m> 1..2
 Specifies the cursor line.
 <n> 1..4
 Specifies the measurement. You can log the results of up to four active measurements.

Return values:
 <Yvalue> Measurement value

Usage: Query only

LOGGer:CURSor:RESult<n>:DELTA?

Returns the difference of the measured values at cursor line 1 and cursor line 2 (Δy on the result display).

Suffix:
 <n> 1..4
 Specifies the measurement. You can log the results of up to four active measurements.

Return values:
 <ResultDelta> Absolute value of the result difference.

Usage: Query only

LOGGer:CURSor<m>:POSition

Returns or sets the timestamp (absolute time) of the specified cursor line (t1 and t2 on the result display).

Suffix:
 <m> 1..2
 Specifies the cursor line.

Parameters:
 <Time> List of values:
 <Year>, <Month>, <Day>, <Hour>, <Minute>, <Second>, <TenthsOfSecond>
 Year, month, day, hour, minute, second, tenth of a second, for example 2015, 10, 29, 16, 10, 22, 2

LOGGer:CURSor:TDELta?

Returns the time difference of the cursor lines (t1 and t2 on the result display).

Return values:
 <DeltaTime> List of values:
 <Day>; <Hour>; <Minute>; <Second>; <TenthsOfSecond>
 Days, hours, minutes, seconds, tenth of a second, for example 1, 9, 10, 22, 5

Usage: Query only

15.10.4 Zoom in Logger mode

LOGGer:ZOOM:ENABLE..... 425
 LOGGer:ZOOM:SCALe..... 426
 LOGGer:ZOOM:POSition.....426

LOGGer:ZOOM:ENABLE <Zoom Enabled>

Enables or disables the logger zoom.

Parameters:
 <Zoom Enabled> ON | OFF
 *RST: OFF

LOGGer:ZOOM:SCALe <Zoom Scale>

Sets the time scale of the zoomed waveform.

Parameters:

<Zoom Scale> AUTO | S1 | S2 | S4 | S5 | S10 | S20 | S40 | M1 | M2 | M4 | M5 |
 M10 | M20 | M40 | H1 | H2 | H4 | H5 | H10 | H20 | D1 | D2 | D4

LOGGer:ZOOM:POSition <Time>

Sets or returns the position of the left edge of the zoomed area in relation to the left side of the display.

Return values:

<Time> List of values:
 <Year>, <Month>, <Day>, <Hour>, <Minute>, <Second>, <TenthsOfSecond>
 Year, month, day, hour, minute, second, tenth of a second, for example 2016, 10, 29, 16, 10, 22, 2

Example: After 5 hours of logging, you want to see the first sample in the zoom. Therefore, you enter the start time as zoom position. If you scale the zoom, the start position remains.

15.10.5 Logger Statistics

The suffix <m> specifies the measurement that is logged.

LOGGer:RECORDing:STARt?	426
LOGGer:RECORDing:TOTal?	427
LOGGer:MEASurement<m>:RESult:CURRentsampl?	427
LOGGer:MEASurement<m>:RESult:MAXimum:POSition?	427
LOGGer:MEASurement<m>:RESult:MAXimum:VALue?	427
LOGGer:MEASurement<m>:RESult:MINimum:POSition?	428
LOGGer:MEASurement<m>:RESult:MINimum:VALue?	428
LOGGer:MEASurement<m>:RESult:MEAN?	428
LOGGer:MEASurement<m>:RESult:STDDev?	428
LOGGer:MEASurement<m>:ENABled?	429
LOGGer:MEASurement<m>:TYPE?	429
LOGGer:MEASurement<m>:SOURce?	429

LOGGer:RECORDing:STARt?

Returns the absolute start time of the current logging session.

Return values:

<StartTime> Year, month, day, hour, minute, second, tenth of a second, for example 2015, 10, 29, 16, 10, 22, 2

Usage: Query only

LOGGer:RECOrding:TOTAL?

Returns the total duration of the current logging session.

Return values:

<Time> List of values:
 <Days>, <Hours>, <Minutes>, <Seconds>,
 <TenthsOfSecond>
 For example: 1, 1, 42, 32, 2

Usage: Query only

LOGGer:MEASurement<m>:RESult:CURRentsampl?

Returns the actual logging value of the selected measurement.

Suffix:

<m> 1..4

Return values:

<CurrentSample> Range: -100E+24 to 100E+24
 Increment: 100E-12
 *RST: 0

Usage: Query only

LOGGer:MEASurement<m>:RESult:MAXimum:POSition?

Returns the time stamp of the maximum logging value of the selected measurement.

Suffix:

<m> 1..4

Return values:

<TimeOfMax>

Usage: Query only

LOGGer:MEASurement<m>:RESult:MAXimum:VALue?

Returns the maximum logging value of the selected measurement.

Suffix:

<m> 1..4

Return values:

<Maximum> Range: -100E+24 to 100E+24
 Increment: 100E-12
 *RST: 0

Usage: Query only

LOGGer:MEASurement<m>:RESult:MINimum:POSition?

Returns the time stamp of the minimum logging value of the selected measurement.

Suffix:

<m> 1..4

Return values:

<TimeOfMin>

Usage: Query only

LOGGer:MEASurement<m>:RESult:MINimum:VALue?

Returns the minimum logging value of the selected measurement.

Suffix:

<m> 1..4

Return values:

<Minimum> Range: -100E+24 to 100E+24
Increment: 100E-12
*RST: 0

Usage: Query only

LOGGer:MEASurement<m>:RESult:MEAN?

Returns the mean logging value of the selected measurement.

Suffix:

<m> 1..4

Return values:

<Average> Range: -100E+24 to 100E+24
Increment: 100E-12
*RST: 0

Usage: Query only

LOGGer:MEASurement<m>:RESult:STDDev?

Returns the standard deviation value of the selected measurement.

Suffix:

<m> 1..4

Return values:

<StdDeviation> Range: -100E+24 to 100E+24
Increment: 100E-12
*RST: 0

Usage: Query only

LOGGer:MEASurement<m>:ENABLEd?

Returns the measurement state of scope and meter measurements.

Suffix:

<m> 1..4

Return values:

<Enabled> ON | OFF
*RST: OFF

Usage: Query only

LOGGer:MEASurement<m>:TYPE?

Returns the measurement type of the selected measurement.

Suffix:

<m> 1..4

Return values:

<Type> See [MEASurement<m>:TYPE](#) on page 341.

Usage: Query only

LOGGer:MEASurement<m>:SOURce?

Returns the source channel of the selected measurement.

Suffix:

<m> 1..4

Return values:

<Source> C1 | C2 | C3 | C4 | M1 | R1 | XY | D0 | D1 | D2 | D3 | D4 | D5 |
D6 | D7

<Source2> C1 | C2 | C3 | C4 | M1 | R1 | XY | D0 | D1 | D2 | D3 | D4 | D5 |
D6 | D7

Example:

```
LOGGer:MEASurement4:SOURce?  
<-- C2,C1
```

Measurement 4 is a delay measurement on source 1 = C2 and
source 2 = C1

Usage: Query only

15.10.6 Logger Records

You can export the data of an active slot to a file, in CSV or MAT format. See also:
[Chapter 8.6, "Export of Logger Records"](#), on page 170.

LOGGer:SLOT:ACTive?	430
LOGGer:SLOT:EXPort:NAME	430
LOGGer:SLOT:EXPort:SAVE	430

LOGGer:SLOT:ACTive?

Returns the active, loaded slot. In stop mode, the loaded (active) slot and selected (current) slot can differ. In run mode, the slots are the same, and this command shows the same as [LOGGer:SLOT:CURRent](#).

Return values:

<LoadedSlot> SLOT1 | SLOT2 | SLOT3 | SLOT4 | SLOT5 | SLOT6 | SLOT7 |
SLOT8 | SLOT9 | SLOT10
*RST: SLOT1

Usage: Query only

LOGGer:SLOT:EXPort:NAME <Name>

Sets the file name, file format and path to save the logger record.

Parameters:

<Name> String with path and file name with extension `.csv` or `.mat`.

LOGGer:SLOT:EXPort:SAVE

Saves the logger record of the active slot to the file specified with [LOGGer:SLOT:EXPort:NAME](#). The active slot is queried with [LOGGer:SLOT:ACTive?](#).

Example:

```
RUN
LOGGer:SLOT:CURRent SLOT2
STOP
LOGGer:SLOT:ACTive?
<-- SLOT2
LOGGer:SLOT:EXPort:NAME '/media/USB1/SLOT2.MAT'
LOGGer:SLOT:EXPort:SAVE
```

Usage: Event

15.11 Protocol Analysis

- [General Protocol Settings](#)..... 431
- [I2C \(Option R&S RTH-K1\)](#)..... 431
- [SPI \(Option R&S RTH-K1\)](#)..... 441
- [UART/RS-232/RS-422/RS-485 \(Option R&S RTH-K2\)](#)..... 449
- [CAN \(Option R&S RTH-K3/R&S RTH-K9\)](#)..... 455
- [LIN \(Option R&S RTH-K3\)](#)..... 470
- [SENT \(Option R&S RTH-K10\)](#)..... 479

15.11.1 General Protocol Settings

BUS:TYPE.....	431
BUS[:STATe].....	431
BUS:FORMat.....	431

BUS:TYPE <Protocol>

Defines protocol type of the bus for configuration and trigger settings.

Parameters:

<Protocol> I2C | SPI | UART | CAN | LIN | SENT
 *RST: I2C

BUS[:STATe] <State>

Enables the decoding and the display of the serial bus data.

Parameters:

<State> ON | OFF
 *RST: OFF

BUS:FORMat <NumberFormat>

Sets the decoding format of the data.

Parameters:

<NumberFormat> BIN | OCT | DEC | HEX | ASCii
 *RST: HEX

15.11.2 I2C (Option R&S RTH-K1)

- I2C Configuration Settings..... 431
- I2C Trigger..... 433
- I2C Decode Results..... 435

15.11.2.1 I2C Configuration Settings

BUS:I2C:SCL:SOURce.....	432
BUS:I2C:SDA:SOURce.....	432
BUS:I2C:TECHnology.....	432
BUS:I2C:SCL:THReshold.....	432
BUS:I2C:SDA:THReshold.....	432
BUS:SETReflevels.....	432

BUS:I2C:SCL:SOURce <Channel>

BUS:I2C:SDA:SOURce <Channel>

Set the input channels of the I2C lines.

Parameters:

<Channel> C1 | C2 | C3 | C4 | D0 | D1 | D2 | D3 | D4 | D5 | D6 | D7

C3 and C4: only R&S RTH1004

Digital channels are available if option R&S RTH-B1 is installed.

*RST: C1

BUS:I2C:TECHnology <ThresholdType>

Sets the threshold values of all I2C lines as defined for various signal technologies.

Parameters:

<ThresholdType> TTL | ECL | CMOS | USER

TTL

1.4 V

ECL

-1.3 V

CMOS

2.5 V

USER

Set a user-defined value for each line using the
BUS:I2C:<line>:THReshold commands.

*RST: TTL

Usage: SCPI confirmed

BUS:I2C:SCL:THReshold <ThresholdValue>

BUS:I2C:SDA:THReshold <ThresholdValue>

Set a user-defined threshold value for the corresponding line if **BUS:I2C:TECHnology** is set to **USER**.

Parameters:

<ThresholdValue> Range: -400 to 400

Increment: 1E-3

*RST: 1.4

Default unit: V

BUS:SETReflevels

Sets the appropriate threshold or threshold for the selected serial protocol.

Usage: Event

15.11.2.2 I2C Trigger

TRIGger:I2C:MODE.....	433
TRIGger:I2C:ADNack.....	433
TRIGger:I2C:DRNack.....	433
TRIGger:I2C:DWNack.....	433
TRIGger:I2C:ACCess.....	434
TRIGger:I2C:ACONdition.....	434
TRIGger:I2C:ADDRess.....	434
TRIGger:I2C:DATA.....	434
TRIGger:I2C:DCONdition.....	435
TRIGger:I2C:DPOStion.....	435

TRIGger:I2C:MODE <TriggerType>

Selects the trigger type for I²C analysis.

Parameters:

<TriggerType> START | REStart | STOP | NACK | ADDRess | DATA | ADAT

NACK = Missing acknowledge bit

ADAT = combination of address and data condition

For details, see "I²C Trigger" on page 186.

*RST: START

TRIGger:I2C:ADNack <TrigOnNoAckForAddress>

Set ON to trigger if no slave recognizes the address.

The command takes effect if **TRIGger:I2C:MODE** is NACK.

Parameters:

<TrigOnNoAckForAddress> ON | OFF

*RST: ON

TRIGger:I2C:DRNack <NoAckDataRead>

Set ON to trigger if the end of the read process is marked when the master reads data from the slave. This Nack is sent according to the protocol definition, it is not an error.

The command takes effect if **TRIGger:I2C:MODE** is NACK.

Parameters:

<NoAckDataRead> ON | OFF

*RST: ON

TRIGger:I2C:DWNack <NoAckDataWrite>

Set ON to trigger if the addressed slave does not accept the written data, and the write data acknowledge bit is missing.

The command takes effect if `TRIGger:I2C:MODE` is `NACK`.

Parameters:

<NoAckDataWrite> ON | OFF
*RST: ON

TRIGger:I2C:ACcEss <ReadWriteBit>

Toggles the trigger condition between read and write access of the master. Select "Either" if the transfer direction is not relevant for the trigger condition.

The command takes effect if `TRIGger:I2C:MODE` is `ADDReSS` or `ADAT`.

Parameters:

<ReadWriteBit> READ | WRITe | EITHer
*RST: EITHer

TRIGger:I2C:ACONdition <Relation>

Defines how the specified serial address pattern is compared with the acquired signal. The instrument triggers if the acquired address is equal or unequal to the pattern.

Parameters:

<Relation> EQUal | NEQUal
*RST: EQUal

TRIGger:I2C:ADDReSS <Pattern>

Specifies the address pattern to be found, in binary format. Enter the pattern in MSB first bit order.

Parameters:

<Pattern> String with max. 7 or 10 characters, depending on the address length. Characters 0, 1, and X are allowed. If you define a pattern shorter than the address length, the missing LSB are filled with X.

Example:

`TRIG:I2C:ADDR "10110"`
Sets the 7 bit address pattern 10110XX.

TRIGger:I2C:DATA <Pattern>

Defines the data pattern as trigger condition. Enter the words in MSB first bit order.

Parameters:

<Pattern> String with max. 4 bytes in binary format. Characters 0, 1, and X are allowed. If you define a pattern with incomplete byte, the missing LSB are filled with X.

Example:

```
TRIGger:I2C:DATA '11111111000000001111'
TRIGger:I2C:DATA?
<-- 11111111000000001111XXXX
```

TRIGger:I2C:DCONDition <Relation>

Defines how the specified data pattern is compared with the acquired signal. The instrument triggers if the acquired data is equal or unequal to the pattern.

Parameters:

<Relation> EQUal | NEQual
*RST: EQUal

TRIGger:I2C:DPOSition <ByteOffset>

Sets the number of bytes before the first byte of the data pattern. These bytes are ignored.

Parameters:

<ByteOffset> Range: 0 to 4095
 Increment: 1
*RST: 0

15.11.2.3 I2C Decode Results

The frame suffix <m> selects the frame index for which the result is queried.

The byte suffix <n> selects the byte index for which the result is queried.

BUS:I2C:FCOunt?.....	436
BUS:I2C:FRAMe<m>:AACcess?.....	436
BUS:I2C:FRAMe<m>:ACCess?.....	436
BUS:I2C:FRAMe<m>:ACOMplete?.....	436
BUS:I2C:FRAMe<m>:ADBStart?.....	437
BUS:I2C:FRAMe<m>:ADDRes?.....	437
BUS:I2C:FRAMe<m>:ADEVice?.....	437
BUS:I2C:FRAMe<m>:AMODE?.....	437
BUS:I2C:FRAMe<m>:ASTart?.....	438
BUS:I2C:FRAMe<m>:BCOunt?.....	438
BUS:I2C:FRAMe<m>:BYTE<n>:ACCess?.....	438
BUS:I2C:FRAMe<m>:BYTE<n>:ACKStart?.....	438
BUS:I2C:FRAMe<m>:BYTE<n>:COMplete?.....	439
BUS:I2C:FRAMe<m>:BYTE<n>:START?.....	439
BUS:I2C:FRAMe<m>:BYTE<n>:VALue?.....	439
BUS:I2C:FRAMe<m>:DATA?.....	440
BUS:I2C:FRAMe<m>:RWBStart?.....	440
BUS:I2C:FRAMe<m>:START?.....	440
BUS:I2C:FRAMe<m>:STATus?.....	440
BUS:I2C:FRAMe<m>:STOP?.....	441

BUS:I2C:FCOut?

Returns the number of decoded frames.

Return values:

<Count>	Total number of decoded frames.
	Range: 0 to 100000
	Increment: 1
	*RST: 0

Usage: Query only

BUS:I2C:FRAME<m>:AACcess?

Returns the address acknowledge bit value for the indicated frame.

Suffix:

<m> *

Return values:

<AddressAckBit>	INComplete ACK NACK EITHer
	*RST: INComplete

Usage: Query only

BUS:I2C:FRAME<m>:ACCess?

Returns the value of the R/W bit of the indicated frame.

Suffix:

<m> *

Return values:

<RWBit>	READ WRITe EITHer UNDeFined
	*RST: UNDeFined

Usage: Query only

BUS:I2C:FRAME<m>:ACOMplete?

Returns if the address is completely contained in the acquisition.

Suffix:

<m> *

Return values:

<AddressComplete>	1 0
	*RST: OFF

Usage: Query only

BUS:I2C:FRAME<m>:ADBStart?

Returns the start time of the address acknowledge bit.

Suffix:

<m> *

Return values:

<AddressAckBitStart> Range: -100E+24 to 100E+24
Increment: 100E-12
*RST: 0
Default unit: s

Usage: Query only

BUS:I2C:FRAME<m>:ADDRess?

Returns the address value of the indicated frame including the R/W bit.

Suffix:

<m> *

Return values:

<Address> Range: 0 to 2047
Increment: 1
*RST: 0

Usage: Query only

BUS:I2C:FRAME<m>:ADEvice?

Returns the pure device address of the indicated frame without the R/W bit.

Suffix:

<m> *

Return values:

<DeviceAddress> Range: 0 to 1023
Increment: 1
*RST: 0

Usage: Query only

BUS:I2C:FRAME<m>:AMODe?

Returns the address length.

Suffix:

<m> *

Return values:

<AddressType> BIT7 | BIT10 | ANY
*RST: BIT7

Usage: Query only

BUS:I2C:FRAME<m>:AStart?

Returns the start time of the address for the indicated frame.

Suffix:

<m> *

Return values:

<AddressStartTime> Range: -100E+24 to 100E+24
 Increment: 100E-12
 *RST: 0
 Default unit: s

Usage: Query only

BUS:I2C:FRAME<m>:BCOut?

Returns the number of bytes in the specified frame.

Suffix:

<m> *

Return values:

<Count> Byte count

Usage: Query only

BUS:I2C:FRAME<m>:BYTE<n>:ACcEss?

Returns the acknowledge bit value of the specified data byte.

Suffix:

<m> *

<n> *

Return values:

<AckBit> INComplete | ACK | NACK | EITHer
 *RST: INComplete

Usage: Query only

BUS:I2C:FRAME<m>:BYTE<n>:ACKStart?

Returns the start time of the acknowledge bit of the specified byte.

Suffix:

<m> *

<n> *

Return values:

<AckBitStartTime> Range: -100E+24 to 100E+24
 Increment: 100E-12
 *RST: 0
 Default unit: s

Usage: Query only

BUS:I2C:FRAME<m>:BYTE<n>:COMPLete?

Returns if the indicated byte is completely contained in the acquisition.

Suffix:

<m> *
 <n> *

Return values:

<IsComplete> 1 | 0
 *RST: OFF

Usage: Query only

BUS:I2C:FRAME<m>:BYTE<n>:STARt?

Returns the start time of the specified data byte.

Suffix:

<m> *
 <n> *

Return values:

<StartTime> Range: -100E+24 to 100E+24
 Increment: 100E-12
 *RST: 0
 Default unit: s

Usage: Query only

BUS:I2C:FRAME<m>:BYTE<n>:VALue?

Returns the data value of the specified byte.

Suffix:

<m> *
 <n> *

Return values:

<Value> Range: 0 to 255
 Increment: 1
 *RST: 0

Usage: Query only

BUS:I2C:FRAME<m>:DATA?

Returns the data words of the specified frame.

Suffix:

<m> *

Parameters:

<Data> Comma-separated list of values.

Usage: Query only

BUS:I2C:FRAME<m>:RWBStart?

Returns the start time of the R/W bit.

Suffix:

<m> *

Return values:

<RWBitStartTime> Range: -100E+24 to 100E+24
Increment: 100E-12
*RST: 0
Default unit: s

Usage: Query only

BUS:I2C:FRAME<m>:START?

Returns the start time of the specified frame.

Suffix:

<m> *

Return values:

<StartTime> Range: -100E+24 to 100E+24
Increment: 100E-12
*RST: 0
Default unit: s

Usage: Query only

BUS:I2C:FRAME<m>:STATUs?

Returns the overall state of the frame.

Suffix:

<m> *

Return values:

<Status> OK | VOID | ADNack | WRNack | SPERror | STERror |
INSufficient

OK

The frame is valid.

VOID

The frame is empty.

ADNack

Missing acknowledge bit after address - no slave recognizes the address.

WRNack

Missing acknowledge bit after written data - the addressed slave does not accept the written data.

SPERror

Stop error, no stop condition found.

STERror

Start error, no start condition found.

INSufficient

The frame is not completely contained in the acquisition. The acquired part of the frame is valid.

*RST: OK

Usage: Query only

BUS:I2C:FRAME<m>:STOP?

Returns the end time of the specified frame.

Suffix:

<m> *

Return values:

<StopTime> Range: -100E+24 to 100E+24
 Increment: 100E-12
 *RST: 0
 Default unit: s

Usage: Query only

15.11.3 SPI (Option R&S RTH-K1)

15.11.3.1 SPI Configuration Settings

BUS:SPI:SCLK:SOURce..... 442
 BUS:SPI:SSEL:SOURce..... 442
 BUS:SPI:MOSI:SOURce..... 442
 BUS:SPI:MISO:SOURce..... 442
 BUS:SPI:SCLK:SLOPe..... 442
 BUS:SPI:SSEL:POLarity..... 442
 BUS:SPI:TECHnology..... 442
 BUS:SPI:SCLK:THReshold..... 443
 BUS:SPI:SSEL:THReshold..... 443

BUS:SPI:MOSI:THReshold.....	443
BUS:SPI:MISO:THReshold.....	443
BUS:SETReflevels.....	443
BUS:SPI:WSIZe.....	443
BUS:SPI:ORDer.....	443
BUS:SPI:TIMEout.....	444

BUS:SPI:SCLK:SOURce <Channel>

BUS:SPI:SSEL:SOURce <Channel>

BUS:SPI:MOSI:SOURce <Channel>

BUS:SPI:MISO:SOURce <Channel>

Set the input channels of the SPI lines.

Parameters:

<Channel> C1 | C2 | C3 | C4 | D0 | D1 | D2 | D3 | D4 | D5 | D6 | D7 | NONE
 C3 and C4: only R&S RTH1004
 Dx: Digital channels are available if option R&S RTH-B1 is installed.
 NONE: not available for clock line SCLK.
 *RST: C1

BUS:SPI:SCLK:SLOPe <ClockEdge>

Selects if data are sampled on the rising or falling slope of the clock. The clock slope marks the begin of a new bit.

Parameters:

<ClockEdge> POSitive | NEGative
 *RST: POSitive

BUS:SPI:SSEL:POLarity <ChipSelectPolarity>

Selects whether the chip select signal is high active (high = 1) or low active (low = 1).

Parameters:

<ChipSelectPolarity> ACTLow | ACTHigh
 *RST: ACTHigh

BUS:SPI:TECHnology <ThresholdType>

Sets the threshold values of all SPI lines as defined for various signal technologies.

Parameters:

<ThresholdType> TTL | ECL | CMOS | USER
TTL
 1.4 V
ECL
 -1.3 V

CMOS

2.5 V

USER

Set a user-defined value for each line using the `BUS:SPI:<line>:THReshold` commands.

*RST: TTL

Usage: SCPI confirmed

BUS:SPI:SCLK:THReshold <ThresholdValue>**BUS:SPI:SSEL:THReshold** <ThresholdValue>**BUS:SPI:MOSI:THReshold** <ThresholdValue>**BUS:SPI:MISO:THReshold** <ThresholdValue>

Set a user-defined value for the corresponding line if `BUS:SPI:TECHnology` is set to USER.

Parameters:

<ThresholdValue> Range: -400 to 400

Increment: 1E-3

*RST: 1.4

Default unit: V

BUS:SETReflevels

Sets the appropriate threshold or threshold for the selected serial protocol.

Usage: Event

BUS:SPI:WSize <WordLength>

Sets the number of bits in a word.

Parameters:

<WordLength> WL4Bit | WL8Bit | WL12bit | WL16bit | WL20bit | WL24bit |

WL28bit | WL32bit

*RST: WL8Bit

BUS:SPI:ORDer <BitOrder>

Defines if the data of the words starts with MSB (most significant bit) or LSB (least significant bit). Results are displayed in the specified order.

Parameters:

<BitOrder> LSBF | MSBF

*RST: MSBF

BUS:SPI:TIMEout <FrameTimeout>

Sets the minimum idle time between two data frames. If the time interval between the data frames is shorter, the words are part of the same frame. Within the timeout, the data and clock lines are low. A new frame begins when the timeout has expired.

Timeout is only relevant if the bus has no chip select.

Parameters:

<FrameTimeout> Range: 500E-9 to 1000
 Increment: 1E-3
 *RST: 1E-3
 Default unit: s

15.11.3.2 SPI Trigger

TRIGger:SPI:MODE.....	444
BUS:SPI:SSEL:STATe.....	444
TRIGger:SPI:DSRC.....	444
TRIGger:SPI:DATA.....	445
TRIGger:SPI:DCondition.....	445
TRIGger:SPI:DPosition.....	445

TRIGger:SPI:MODE <TriggerType>

Selects the trigger type for SPI analysis.

Parameters:

<TriggerType> FRST | FREN | DATA
 FRST = frame start
 FREN = frame end
 DATA = data.
 For details, see "[SPI Trigger](#)" on page 196.
 *RST: FRST

BUS:SPI:SSEL:STATe <UseChipSelect>

Defines if the SPI bus uses a chip select line or not.

Parameters:

<UseChipSelect> ON | OFF
 *RST: ON

TRIGger:SPI:DSRC <DataSource>

Selects the line, on which the trigger pattern is expected.

Parameters:

<DataSource> MISO | MOSI
 *RST: MISO

TRIGger:SPI:DATA <Pattern>

Specifies the data pattern to be found on the specified line, in binary format. Enter the words in MSB first bit order.

Parameters:

<Pattern> String with max. 32 bit in binary format. Characters 0, 1, and X are allowed.

Example:

```
TRIGger:SPI:DATA '111000'
TRIGger:SPI:DATA?
<--111000
```

Specifies a 6 bit pattern. Higher bits are omitted.

TRIGger:SPI:DCONDition <Relation>

Defines how the specified data pattern is compared with the acquired signal. The instrument triggers if the acquired data is equal or unequal to the pattern.

Parameters:

<Relation> EQUal | NEQual
*RST: EQUal

TRIGger:SPI:DPOSition <BitOffset>

Sets the number of bits before the first bit of the pattern. These bits are ignored. The first bit after CS or timeout is bit 0.

Parameters:

<BitOffset> Range: 0 to 4095
Increment: 1
*RST: 0

15.11.3.3 SPI Decode Results

The frame suffix <m> selects the frame index for which the result is queried.

The byte suffix <n> selects the byte index for which the result is queried.

BUS:SPI:FCOunt?	446
BUS:SPI:FRAMe<m>:DATA?	446
BUS:SPI:FRAMe<m>:STATus?	446
BUS:SPI:FRAMe<m>:STARt?	446
BUS:SPI:FRAMe<m>:STOP?	447
BUS:SPI:FRAMe<m>:WCOunt?	447
BUS:SPI:FRAMe<m>:WORD<n>:MISO?	447
BUS:SPI:FRAMe<m>:WORD<n>:MOSI?	448
BUS:SPI:FRAMe<m>:WORD<n>:STARt?	448
BUS:SPI:FRAMe<m>:WORD<n>:STOP?	448

BUS:SPI:FCOut?

Returns the number of decoded frames.

Return values:

<Count>	Total number of decoded frames.
	Range: 0 to 100000
	Increment: 1
	*RST: 0

Usage: Query only

BUS:SPI:FRAME<m>:DATA?

Returns the data words of the specified frame.

Suffix:

<m>	*
	Selects the frame.

Parameters:

<Data>	List of decimal values of data bytes
--------	--------------------------------------

Example:

```
BUS:SPI:FRAM3:DATA?
<-- 94,177,171,60,242,219,100,0
```

Usage: Query only

BUS:SPI:FRAME<m>:STATus?

Returns the overall status of the specified frame.

Suffix:

<m>	*
	Selects the frame.

Return values:

<State>	OK VOID FRERror INSufficient
	VOID: The frame is empty.
	FRERror: error in the frame.
	INSufficient: frame is not completely contained in the acquisition. The acquired part of the frame is valid.
	*RST: OK

Usage: Query only

BUS:SPI:FRAME<m>:START?

Returns the start time of the specified frame.

Suffix:

<m>	*
	Selects the frame.

Return values:

<StartTime> Range: -100E+24 to 100E+24
 Increment: 100E-12
 *RST: 0
 Default unit: s

Usage: Query only

BUS:SPI:FRAME<m>:STOP?

Returns the end time of the specified frame.

Suffix:

<m> *
 Selects the frame.

Return values:

<StopTime> Range: -100E+24 to 100E+24
 Increment: 100E-12
 *RST: 0
 Default unit: s

Usage: Query only

BUS:SPI:FRAME<m>:WCOunt?

Returns the number of words in the specified frame.

Suffix:

<m> *
 Selects the frame.

Return values:

<Count> Number of words

Usage: Query only

BUS:SPI:FRAME<m>:WORD<n>:MISO?

Returns the data value of the specified word on the MISO line.

Suffix:

<m> *
 Selects the frame.

<n> *
 Selects the word number.

Return values:

<MISOValue> Decimal value of the data word
 Range: 0 to 4294967295
 Increment: 1
 *RST: 0

Usage: Query only

BUS:SPI:FRAME<m>:WORD<n>:MOSI?

Returns the data value of the specified word on the MOSI line.

Suffix:

<m> *
Selects the frame.

<n> *
Selects the word number.

Return values:

<MOSIValue> Decimal value of the data word
Range: 0 to 4294967295
Increment: 1
*RST: 0

Usage: Query only

BUS:SPI:FRAME<m>:WORD<n>:START?

Returns the start time of the specified data word.

Suffix:

<m> *
Selects the frame.

<n> *
Selects the word number.

Return values:

<StartTime> Range: -100E+24 to 100E+24
Increment: 100E-12
*RST: 0
Default unit: s

Usage: Query only

BUS:SPI:FRAME<m>:WORD<n>:STOP?

Returns the end time of the specified data word.

Suffix:

<m> *
Selects the frame.

<n> *
Selects the word number.

Return values:

<StopTime> Range: -100E+24 to 100E+24
 Increment: 100E-12
 *RST: 0
 Default unit: s

Usage: Query only

15.11.4 UART/RS-232/RS-422/RS-485 (Option R&S RTH-K2)

- [UART Configuration](#)..... 449
- [UART Trigger](#)..... 452
- [UART Decode Results](#)..... 453

15.11.4.1 UART Configuration

BUS:UART:SOURce	449
BUS:UART:POLarity	449
BUS:UART:TECHnology	450
BUS:UART:THReshold	450
BUS:SETReflevels	450
BUS:UART:STDBitrate	450
BUS:UART:BITRate	451
BUS:UART:SSIZe	451
BUS:UART:PARity	451
BUS:UART:SBIT	451
BUS:UART:ORDer	451
BUS:UART:FRAMemode	452
BUS:UART:TOUT	452

BUS:UART:SOURce <Channel>

Selects the input channel of the UART line.

Parameters:

<Channel> C1 | C2 | C3 | C4 | D0 | D1 | D2 | D3 | D4 | D5 | D6 | D7

C3 and C4: only R&S RTH1004

Digital channels are available if option R&S RTH-B1 is installed.

*RST: C1

BUS:UART:POLarity <Polarity>

Defines the logic states of the line. In idle high state, the idle state corresponds to a logic 1, and the start bit to a logic 0. In idle low state, the idle state corresponds to a logic 0, and the start bit to a logic 1. During idle time, no data is transmitted.

Parameters:

<Polarity> IDLLow | IDLHigh

*RST: IDLHigh

BUS:UART:TECHnology <ThresholdType>

Sets the threshold value of the UART line as defined for various signal technologies.

Parameters:

<ThresholdType> TTL | ECL | CMOS | USER

TTL
1.4 V

ECL
-1.3 V

CMOS
2.5 V

USER
Set a user-defined value using [BUS:UART:THReshold](#).

*RST: TTL

BUS:UART:THReshold <ThresholdValue>

Sets an individual threshold value for digitization of signals if [BUS:UART:TECHnology](#) is set to `USER`.

Parameters:

<ThresholdValue> Range: -400 to 400
Increment: 1E-3
*RST: 1.4
Default unit: V

BUS:SETReflevels

Sets the appropriate threshold or threshold for the selected serial protocol.

Usage: Event

BUS:UART:STDBitrate <Bitrate>

Sets the number of transmitted bits per second.

Parameters:

<Bitrate> BPS_300 | BPS_600 | BPS_1200 | BPS_2400 | BPS_4800 |
BPS_9600 | BPS_14400 | BPS_19200 | BPS_28800 |
BPS_38400 | BPS_56000 | BPS_57600 | BPS_115200 |
BPS_128000 | BPS_230400 | BPS_460800 | BPS_921600 |
CUSTom

Values in bits per second.
CUSTom: Set the bit rate using [BUS:UART:BITRate](#).

*RST: BPS_14400

BUS:UART:BITRate <CustomBitrate>

Sets a user-defined bit rate if **BUS:UART:STDBitrate** is set to **CUSTOM**.

Parameters:

<CustomBitrate> Range: 300 to 2000000
 Increment: 1
 *RST: 14400
 Default unit: bps

BUS:UART:SSIZE <DataBits>

Sets the number of data bits in a word (symbol).

Parameters:

<DataBits> B5 | B6 | B7 | B8 | B9
 *RST: B8

BUS:UART:PARity <Parity>

Defines the optional parity bit that is used for error detection.

Parameters:

<Parity> NONE | ODD | EVEN
NONE
No parity bit is used.
ODD
The parity bit is set to "1" if the number of data bits set to "1" is even.
EVEN
The parity bit is set to "1" if the number of data bits set to "1" is odd.
*RST: NONE

BUS:UART:SBIT <StopBits>

Sets the number of stop bits: 1 or 1.5 or 2 stop bits are possible.

Parameters:

<StopBits> B1 | B15 | B2
 *RST: B1

BUS:UART:ORDER <BitOrder>

Defines if a word starts with MSB (most significant bit) or LSB (least significant bit). The display of the decoded signal considers this setting, results are displayed in the specified order.

Parameters:

<BitOrder> LSBF | MSBF
 *RST: MSBF

BUS:UART:FRAMemode <FrameMode>

IDLE defines frames of several words in the data stream, which are defined by a timeout between a stop bit and the next start bit. Enter the minimum timeout between two frames using [BUS:UART:TOUT](#).

Parameters:

<FrameMode> NONE | IDLE
 *RST: NONE

BUS:UART:TOUT <IdleTime>

Sets the minimum timeout between two frames if [BUS:UART:FRAMemode](#) is set to IDLE.

Parameters:

<IdleTime> Range: 100E-9 to 1
 Increment: 1E-3
 *RST: 1E-3
 Default unit: s

15.11.4.2 UART Trigger

TRIGger:UART:TYPE	452
TRIGger:UART:DATA	453
TRIGger:UART:DCondition	453

TRIGger:UART:TYPE <TriggerType>

Selects the trigger type for UART analysis.

Parameters:

<TriggerType> STBT | PCKS | DATA | PRER | STPerror | BRKC
 STBT = start bit
 PCKS = frame start
 PRER = parity error
 STPerror = stop error
 BRKC = break condition
 DATA: : data. To set up the trigger condition, use [TRIGger:UART:DATA](#), and [TRIGger:UART:DCondition](#).
 For details, see "UART Trigger" on page 203.
 *RST: STBT

TRIGger:UART:DATA <Pattern>

Defines the data pattern as trigger condition. Enter the words in MSB first bit order.

Parameters:

<Pattern> String with max. 8 bit in binary format. Characters 0, 1, and X are allowed.

Example:

```
TRIGger:UART:DATA '1x11'
TRIGger:UART:DATA?
1X11
```

TRIGger:UART:DCONDition <Relation>

Defines how the specified data pattern is compared with the acquired signal. The instrument triggers if the acquired data is equal or unequal to the pattern.

Parameters:

<Relation> EQUal | NEQual
*RST: EQUal

15.11.4.3 UART Decode Results

The frame suffix <m> selects the frame index for which the result is queried.

The byte suffix <n> selects the byte index for which the result is queried.

BUS:UART:WCOunt?.....	453
BUS:UART:WORD<m>:STATe?.....	453
BUS:UART:WORD<m>:START?.....	454
BUS:UART:WORD<m>:STOP?.....	454
BUS:UART:WORD<m>:VALue?.....	455

BUS:UART:WCOunt?

Returns the number of decoded symbols (words).

Return values:

<Count> Total number of decoded words.
Range: 0 to 100000
Increment: 1
*RST: 0

Usage: Query only

BUS:UART:WORD<m>:STATe?

Returns the status of the specified symbol (word).

Suffix:

<m> *
Selects the word.

Return values:

<State> OK | BREak | STERror | SPERror | PRERror | INSufficient
 OK: the frame is valid.
 BREak: break condition found. A start bit is not followed by a stop bit, and the data line remains at logic 0 for longer than a UART word.
 STERror: start error, no start bit found.
 SPERror: stop error, no stop condition found.
 PRERror: parity error, which indicates a transmission error.
 INSufficient: the frame is not completely contained in the acquisition. The acquired part of the frame is valid.
 *RST: OK

Usage: Query only

BUS:UART:WORD<m>:START?

Returns the start time of the specified symbol (word).

Suffix:

<m> *
Selects the word.

Return values:

<StartTime> Range: -100E+24 to 100E+24
 Increment: 100E-12
 *RST: 0
 Default unit: s

Usage: Query only

BUS:UART:WORD<m>:STOP?

Returns the end time of the specified symbol (word).

Suffix:

<m> *
Selects the word.

Return values:

<StopTime> Range: -100E+24 to 100E+24
 Increment: 100E-12
 *RST: 0
 Default unit: s

Usage: Query only

BUS:UART:WORD<m>:VALue?

Return the value of the specified symbol (word).

Suffix:

<m> *
Selects the word.

Return values:

<Value> Decimal value
Range: 0 to 255
Increment: 1
*RST: 0

Usage: Query only

15.11.5 CAN (Option R&S RTH-K3/R&S RTH-K9)

- [CAN Configuration Settings](#)..... 455
- [CAN Trigger](#)..... 459
- [CAN Decode Results](#)..... 463

15.11.5.1 CAN Configuration Settings

BUS:CAN:DATA:SOURce	455
BUS:CAN:TYPE	456
BUS:CAN:BITRate	456
BUS:CAN:TECHnology	456
BUS:CAN:DATA:THReshold	457
BUS:SETReflevels	457
BUS:CAN:SAMPlepoint	457
BUS:CAN:FDATa:ABITrate	457
BUS:CAN:FDATa:ASAMplepoint	457
BUS:CAN:FDATa:DBITrate	458
BUS:CAN:FDATa:DSAMplepoint	458
BUS:CAN:FDATa:ENABle	458
BUS:CAN:FDATa:PSTandard	458

BUS:CAN:DATA:SOURce <Channel>

Sets the input channel of the CAN line.

Parameters:

<Channel> C1 | C2 | C3 | C4 | D0 | D1 | D2 | D3 | D4 | D5 | D6 | D7
C3 and C4: only R&S RTH1004
Digital channels are available if option R&S RTH-B1 is installed.
*RST: C1

Usage: Asynchronous command

BUS:CAN:TYPE <SignalType>

Selects whether the chip select signal is high active (high = 1) or low active (low = 1).

Parameters:

<SignalType> CANH | CANL

CANH

Signal is high active (high = 1).

CANL

Signal is low active (low = 1).

*RST: CANL

BUS:CAN:BITRate <CustomBitrate>

Sets the number of transmitted bits per second.

Parameters:

<CustomBitrate> Range: 10000 to 1000000

Increment: 1

*RST: 50000

Default unit: bps

BUS:CAN:TECHnology <ThresholdType>**Parameters:**

<ThresholdType> TTL | ECL | CMOS | CAN | GND | LIN7vsupply | LIN12vsupply | LIN18vsupply | USER

TTL

1.4 V

ECL

-1.3 V

CMOS

2.5 V

GND

0 V (for CAN channels, requires option R&S RTH-K3)

CAN

2 V (for CAN channels, requires option R&S RTH-K3)

LIN7vsupply | LIN12vsupply | LIN18vsupply

7 V / 12 V / 18 V (for LIN channels, requires option R&S RTH-K3)

USER

Set the value with `CHANnel<m>:THReshold:USER`.

*RST: CAN

BUS:CAN:DATA:THReshold <ThresholdValue>

Sets the threshold value for digitization of signals manually. If the signal value is higher than the threshold, the signal state is high. Otherwise, the signal state is considered low.

This value is only considered for `BUS:CAN:TECHnology` USER

Parameters:

<ThresholdValue> Range: -400 to 400
 Increment: 1E-3
 *RST: 1.4
 Default unit: V

BUS:SETReflevels

Sets the appropriate threshold or threshold for the selected serial protocol.

Usage: Event

BUS:CAN:SAMPlEpoint <SamplePoint>

The sample point divides the nominal bit period into two distinct time segments. The length of the time segments is defined in time quanta according to network and node conditions during CAN development.

Parameters:

<SamplePoint> Range: 10 to 95
 Increment: 1
 *RST: 50
 Default unit: %

BUS:CAN:FDATa:ABITrate <ArbCustomBitrate>

Sets the bit rate of the arbitration phase of the CAN FD bus.

The setting is available in CAN FD option R&S RTH-K9.

Parameters:

<ArbCustomBitrate> Range: 10000 to 1000000
 Increment: 1
 *RST: 50000
 Default unit: bps

BUS:CAN:FDATa:ASAMPlEpoint <ArbSamplePoint>

The sample point divides the arbitration phase into two distinct time segments. The length of the time segments is defined in time quanta according to network and node conditions during CAN FD development.

The setting is available in CAN FD option R&S RTH-K9.

Parameters:

<ArbSamplePoint> Range: 10 to 95
 Increment: 1
 *RST: 66
 Default unit: %

BUS:CAN:FData:DBITrate <DataCustomBitrate>

Sets the bit rate of the data phase. The data rate can be higher than the arbitration rate, but it is uniform and fixed for a given CAN FD bus.

The setting is available in CAN FD option R&S RTH-K9.

Parameters:

<DataCustomBitrate> Range: 10000 to 15000000
 Increment: 1
 *RST: 50000
 Default unit: bps

BUS:CAN:FData:DSAMplepoint <DataSamplePoint>

The sample point divides the data phase into two distinct time segments. The length of the time segments is defined in time quanta according to network and node conditions during CAN FD development.

The setting is available in CAN FD option R&S RTH-K9.

Parameters:

<DataSamplePoint> Range: 10 to 95
 Increment: 1
 *RST: 66
 Default unit: %

BUS:CAN:FData:ENABle <State>

Enables the CAN FD protocol configuration. It `BUS:CAN:FData:ENABle` state is `OFF`, then the CAN protocol is selected.

The setting is available in CAN FD option R&S RTH-K9.

Parameters:

<State> ON | OFF

BUS:CAN:FData:PStandard <ProtocolStandard>

Only available for CAN FD buses. Selects if the tested signal is an ISO CAN FD signal or not.

Parameters:

<ProtocolStandard> ISO | NISO

ISO

Signals are decoded according to the ISO CAN FD protocol. This protocol has an additional stuff count field before the CRC sequence.

NISO

Non-ISO. Signals are decoded according to the Bosch CAN FD protocol.

*RST: ISO

15.11.5.2 CAN Trigger

TRIGger:CAN:ACKerror.....	459
TRIGger:CAN:BITSterror.....	459
TRIGger:CAN:CRCErrror.....	460
TRIGger:CAN:DATA.....	460
TRIGger:CAN:DCONdition.....	460
TRIGger:CAN:FORMerror.....	460
TRIGger:CAN:FTYPE.....	460
TRIGger:CAN:ICONdition.....	461
TRIGger:CAN:IDENtifier.....	461
TRIGger:CAN:ITYPe.....	461
TRIGger:CAN:TYPE.....	462
TRIGger:CAN:FDATA:BRS.....	462
TRIGger:CAN:FDATA:DPOStition.....	463
TRIGger:CAN:FDATA:ESI.....	463
TRIGger:CAN:FDATA:FDF.....	463
TRIGger:CAN:FDATA:SCERror.....	463

TRIGger:CAN:ACKerror <AckError>

An acknowledgement error occurs when the transmitter does not receive an acknowledgment - a dominant bit during the Ack slot.

Parameters:

<AckError> ON | OFF
 *RST: ON

TRIGger:CAN:BITSterror <StuffBitError>

A stuff error occurs when the 6th consecutive equal bit level in the mentioned fields is detected.

Parameters:

<StuffBitError> ON | OFF
 *RST: ON

TRIGger:CAN:CRCError <CrcError>

A CRC error occurs when the calculated result differs from the received value in the CRC sequence.

Parameters:

<CrcError> ON | OFF
 *RST: ON

TRIGger:CAN:DATA <Pattern>

Specifies the data pattern to be found, in binary or hex format. Enter the pattern in MSB first bit order.

Parameters:

<Pattern> String that contains the pattern in binary format. The parameter accepts the bit value X (don't care).

TRIGger:CAN:DCONdition <Relation>

Defines how the specified data pattern is compared with the acquired signal. The instrument triggers if the acquired address is equal or unequal the defined pattern.

Parameters:

<Relation> EQUal | NEQual
 *RST: EQUal

TRIGger:CAN:FORMerror <FormError>

A form error occurs when a fixed-form bit field contains one or more illegal bits.

Parameters:

<FormError> ON | OFF
 *RST: ON

TRIGger:CAN:FTYPE <FrameType>

CAN has several frame types which can be used as trigger condition.

For data and remote frames, the identifier format has to be set with [TRIGger:CAN:ITYPE](#).

Parameters:

<FrameType> ERRor | OVERload | DATA | REMote | DOR

ERRor

When a node recognizes an error, it cancels transmission by sending an error frame.

The instrument triggers seven bit periods after the end of the error flag that is marked by a dominant-recessive edge.

OVERload

When a node needs a delay between data and/or remote frames, it sends an overload frame.

DATA

The data frame is the only frame for actual data transmission.

REMOte

Remote frames are only available in the CAN protocol. The remote frame initiates the transmission of data by another node. The frame format is the same as of data frames but without the data field.

DOR

Data frames or remote frames initiate the transmission of data by another node. The frame format is the same as of data frames.

*RST: DOR

TRIGger:CAN:ICONdition <Relation>

Defines how the specified identifier pattern is compared with the acquired signal. The instrument triggers if the acquired address is equal or unequal the defined pattern.

Parameters:

<Relation> EQUal | NEQual
*RST: EQUal

TRIGger:CAN:IDENtifier <Pattern>

Specifies the identifier pattern to be found, in binary format. Enter the pattern in MSB first bit order.

Parameters:

<Pattern> String that contains the pattern in binary format. The parameter accepts the bit value X (don't care).

Example:

```
TRIG:CAN:TYPE ID
TRIG:CAN:IDEN 001001
TRIG:CAN:ICON EQU
Triggers if the ID of the measured signal is 001001.
```

TRIGger:CAN:ITYPE <IdentifierType>

Selects the length of the identifier.

Parameters:

<IdentifierType> B11 | B29 | ANY

ANY

The ID type and ID pattern are not relevant for the trigger condition.

If the trigger type is "Identifier", the instrument triggers on any identifier in the specified frame type.

If the trigger type is "Identifier + Data", set the "ID type" to "Any" if you want to trigger only on data.

*RST: ANY

TRIGger:CAN:TYPE <TriggerType>

Depending on the selected CAN trigger type, different additional parameters are available.

Parameters:

<TriggerType> STOF | EOF | FTYP | ID | IDDT | ERRC

STOF

Triggers on the stop bit of the sync field.

EOF

Triggers after a wakeup frame.

FTYP

Triggers on a specified frame type (data, remote, error, or overload). For data and remote frames, also the identifier format is considered.

ID

Sets the trigger to a specific identifier or an identifier range. Only the 6-bit identifier without parity bits is considered, not the protected identifier.

IDDT

Sets the trigger to a combination of identifier and data condition. The instrument triggers at the end of the last byte of the specified data pattern.

ERRC

Identifies various errors in the frame. You can select one or more error types as the trigger condition.

*RST: STOF

TRIGger:CAN:FDATA:BRS <BRSBit>

Sets the bit rate switch bit.

Parameters:

<BRSBit> ZERO | ONE | DC

*RST: DC

TRIGger:CAN:FDATa:DPOStion <ByteOffset>

Sets the byte offset, that defines the start position of the data for the data pattern comparison.

The setting is available in CAN FD option R&S RTH-K9.

Parameters:

<ByteOffset> Range: 0 to 63
 Increment: 1
 *RST: 0

TRIGger:CAN:FDATa:ESI <ESIBit>

Sets the error state indicator bit.

Parameters:

<ESIBit> ZERO | ONE | DC
 DC: do not care, bit is nor relevant.
 *RST: DC

TRIGger:CAN:FDATa:FDf <FDfBit>

Specifies the CAN FD frame format. It corresponds to the EDL bit (extended data length), which only exists in CAN FD format.

Parameters:

<FDfBit> ZERO | ONE | DC
 ONE: CAN FD
 ZERO: CAN.
 DC: do not care, the format is not relevant.
 *RST: DC

TRIGger:CAN:FDATa:SCERror <StuffCountError>

Triggers on stuff count errors. A stuff count error occurs if the received stuff count value does not match the value calculated from the own stuff bit count.

Only relevant for CAN FD signals in ISO standard (`BUS:CAN:FDATa:PStandard` is set to `ISO`).

Parameters:

<StuffCountError> ON | OFF
 *RST: ON

15.11.5.3 CAN Decode Results

The frame suffix <m> selects the frame index for which the result is queried.

The byte suffix <n> selects the byte index for which the result is queried.

BUS:CAN:FCOunt?	464
BUS:CAN:FRAMe<m>:ACKValue?	464
BUS:CAN:FRAMe<m>:BSEPosition?	464
BUS:CAN:FRAMe<m>:BYTE<n>:STATe?	465
BUS:CAN:FRAMe<m>:BYTE<n>:VALue?	465
BUS:CAN:FRAMe<m>:CSValue?	465
BUS:CAN:FRAMe<m>:DATA?	466
BUS:CAN:FRAMe<m>:DLCValue?	466
BUS:CAN:FRAMe<m>:ACKState?	466
BUS:CAN:FRAMe<m>:CSSTate?	466
BUS:CAN:FRAMe<m>:DLCState?	466
BUS:CAN:FRAMe<m>:IDSTate?	466
BUS:CAN:FRAMe<m>:IDTYpe?	467
BUS:CAN:FRAMe<m>:IDValue?	467
BUS:CAN:FRAMe<m>:NDBYtes?	467
BUS:CAN:FRAMe<m>:SDATA?	468
BUS:CAN:FRAMe<m>:START?	468
BUS:CAN:FRAMe<m>:STOP?	468
BUS:CAN:FDATa:FRAMe<m>:STANdard?	468
BUS:CAN:FRAMe<m>:STATus?	468
BUS:CAN:FRAMe<m>:SYMBol?	469
BUS:CAN:FRAMe<m>:TYPE?	469

BUS:CAN:FCOunt?

Returns the number of decoded frames in the acquisition.

Return values:

<Count>	Range:	0 to 100000
	Increment:	1
	*RST:	0

Usage: Query only

BUS:CAN:FRAMe<m>:ACKValue?

Returns the value of the acknowledge slot for the selected frame.

Suffix:

<m>	*
-----	---

Return values:

<AckValue>	Range:	0 to 1
	*RST:	0

Usage: Query only

BUS:CAN:FRAMe<m>:BSEPosition?

Returns the location of a bit stuffing error.

Suffix:

<m> *

Return values:

<BitStuffErrorPos> Range: -100E+24 to 100E+24
 Increment: 100E-12
 *RST: 0
 Default unit: s

Usage: Query only**BUS:CAN:FRAMe<m>:BYTE<n>:STATe?**

Returns the state of the specified byte.

Suffix:

<m> *

<n> *

Return values:

<ByteState> OK | UNDF
 UNDF: Undefined
 *RST: OK

Usage: Query only**BUS:CAN:FRAMe<m>:BYTE<n>:VALue?**

Returns the value of the specified byte.

Suffix:

<m> *

<n> *

Return values:

<ByteValue> Range: 0 to 255
 *RST: 0

Usage: Query only**BUS:CAN:FRAMe<m>:CSValue?**

Returns the CRC sequence value of the selected frame.

Suffix:

<m> *

Return values:

<ChecksumValue> Range: 0 to 2097151
 *RST: 0

Usage: Query only

BUS:CAN:FRAME<m>:DATA?

Returns the data of the specified frame.

Suffix:

<m> *

Return values:

<Data> Comma-separated list of integer values. The first value is the number of bytes, followed by the values of the data bytes.

Example:

```
BUS1:CAN:FRAME2:DATA?
--> 3,208,231,32
```

Returns the data of the second frame: the number of bytes is 3 data (first value).

Usage:

Query only

BUS:CAN:FRAME<m>:DLCValue?

Returns the number of data bytes in the frame.

CAN: the number of data bytes is the data length code (DLC).

CAN FD: for DLCs > 8, the DLC and the number of data bytes are different. The DLC is defined in the standard. For example, DLC = 9 defines that the data field has 12 bytes, and DLC = 15 sets a 64 byte data field.

Suffix:

<m> *
Frame index

Return values:

<DataBytes> Number of data bytes in decimal values.

Range: 0 to 64

*RST: 0

Usage:

Query only

BUS:CAN:FRAME<m>:ACKState?**BUS:CAN:FRAME<m>:CSSTate?****BUS:CAN:FRAME<m>:DLCState?****BUS:CAN:FRAME<m>:IDSTate?**

Return the states of the following parts of a message:

- ACKState: state of acknowledgement field
- CSSTate: state of checksum field (CRC)
- DLCState: state of data length code
- IDSTate: identifier state

Suffix:

<m> *

Return values:

<State> OK | UNDF
 UNDF: Undefined
 *RST: OK

Usage: Query only

BUS:CAN:FRAME<m>:IDType?

Returns the identifier type of the selected frame, the identifier format of data and remote frames.

Suffix:

<m> *

Return values:

<IdentifierType> ANY | B11 | B29
 B11: standard format, 11 bit
 B29: extended format, 29 bit
 *RST: B11

Usage: Query only

BUS:CAN:FRAME<m>:IDValue?

Returns the identifier value of the selected frame.

Suffix:

<m> *

Return values:

<IdentifierValue> Range: 0 to 536870911
 *RST: 0

Usage: Query only

BUS:CAN:FRAME<m>:NDBytes?

Returns the number of data bytes of the selected frame.

Suffix:

<m> *

Return values:

<NoOfDataBytes> Range: 0 to 64
 Increment: 1
 *RST: 0

Usage: Query only

BUS:CAN:FRAME<m>:SDATa?

Returns the complete symbolic data of the selected frame.

Suffix:

<m> *

Return values:

<SymbolicData> String with comma-separated list of symbolic data

Example:

```
BUS:CAN:FRAME9:SDATa?
```

```
<-- [sym] 325 kW, 0x0A, 423 N, 174 l, Running, 90 degC, 0x06, 437 rpm
```

Returns the symbolic results of the 9th frame.

Usage:

Query only

BUS:CAN:FRAME<m>:START?**BUS:CAN:FRAME<m>:STOP?**

Returns the start time and stop time of the selected frame.

Suffix:

<m> *

Return values:

<FrameStart> Time

<FrameStop> Range: -100E+24 to 100E+24

*RST: 0

Default unit: s

Usage:

Query only

BUS:CAN:FDATa:FRAME<m>:STANdard?

Returns the CAN standard.

The setting is available in CAN FD option R&S RTH-K9.

Suffix:

<m> *

Return values:

<FrameStandard> CAN | CANFd

*RST: CAN

Usage:

Query only

BUS:CAN:FRAME<m>:STATus?

Returns the overall state of the selected frame.

Suffix:

<m> *

Return values:

<FrameState> OK | OVLD | ERR | BTST | CRC | NOACK | SERRror | FORM | CAERror | FCERror | SCERror | SAERror | SFERror | SCAE | SCFE | INSufficient

Status for CAN and CAN FD:

OK: the frame is valid.

OVLD: Overload frame

ERR: Error frame

BTST: Bit stuffing error occurred.

CRC: Cyclic redundancies check failed.

NOACK: Acknowledge is missing.

FORM: Fixed-bit form error

CAERror: CRC error followed by an acknowledgement error (missing acknowledge)

FCERror: CRC error followed by a form error (wrong CRC delimiter or wrong ACK delimiter)

INSufficient: The frame is not contained completely in the acquisition. The acquired part of the frame is valid.

Status for CAN FD only:

SERRror: Stuff count error

SAERror: Stuff count error followed by acknowledgement error

SFERror: Stuff count error followed by a form error

SCAE: Stuff count error followed by CRC error and acknowledgement error

SCFE: Stuff count error followed by CRC error and form error

*RST: OK

Usage: Query only**BUS:CAN:FRAMe<m>:SYMBol?**

Returns the symbolic label of the specified frame if the label list is enabled.

Suffix:

<m> *

Return values:

<Label> String with symbolic label of the identifier

Usage: Query only**BUS:CAN:FRAMe<m>:TYPE?**

Returns the frame type of the selected frame.

Suffix:

<m> *

Parameters:

<FrameType> ERRor | OVERload | DATA | REMote | DOR

ERRor

When a node recognizes an error, it cancels transmission by sending an error frame.

The instrument triggers seven bit periods after the end of the error flag that is marked by a dominant-recessive edge.

OVERload

When a node needs a delay between data and/or remote frames, it sends an overload frame.

DATA

The data frame is the only frame for actual data transmission.

REMote

Remote frames are only available in the CAN protocol.

The remote frame initiates the transmission of data by another node. The frame format is the same as of data frames but without the data field.

DOR

Data frames or remote frames initiate the transmission of data by another node. The frame format is the same as of data frames.

*RST: DOR

Usage: Query only

15.11.6 LIN (Option R&S RTH-K3)

- [LIN Configuration Settings](#)..... 470
- [LIN Trigger](#)..... 472
- [LIN Decode Results](#)..... 474

15.11.6.1 LIN Configuration Settings

[BUS:LIN:DATA:SOURce](#)..... 470

[BUS:LIN:POLarity](#)..... 471

[BUS:LIN:BITRate](#)..... 471

[BUS:LIN:STANdard](#)..... 471

[BUS:LIN:DATA:THReshold](#)..... 471

[BUS:LIN:TECHnology](#)..... 472

[BUS:SETReflevels](#)..... 472

BUS:LIN:DATA:SOURce <Channel>

Sets the source of the data line. All channel waveforms can be used.

Parameters:

<Channel> C1 | C2 | C3 | C4 | D0 | D1 | D2 | D3 | D4 | D5 | D6 | D7
 C3 and C4: only R&S RTH1004
 Digital channels are available if option R&S RTH-B1 is installed.
 *RST: C1

Usage:

Asynchronous command

BUS:LIN:POLarity <Polarity>

Defines the idle state of the bus. The idle state is the recessive state and corresponds to a logical 1.

Parameters:

<Polarity> IDLLow | IDLHigh

IDLLow

The bus is idle (state = 1) when the signal is low

IDLHigh

The bus is idle (state = 1) when the signal is high

*RST: IDLHigh

BUS:LIN:BITRate <CustomBitrate>

Sets the number of transmitted bits per second.

Parameters:

<CustomBitrate> Range: 1000 to 20000
 Increment: 1
 *RST: 9600
 Default unit: bps

BUS:LIN:STANdard <Standard>

Selects the version of the LIN standard that is used in the DUT. The setting mainly defines the checksum version used during decoding.

Parameters:

<Standard> V1X | V2X | J2602 | AUTO
 *RST: AUTO

BUS:LIN:DATA:THReshold <ThresholdValue>

Sets the threshold value for digitization of signals manually. If the signal value is higher than the threshold, the signal state is high. Otherwise, the signal state is considered low.

This value is only considered for `BUS:LIN:TECHnology` USER

Parameters:

<ThresholdValue> Range: -400 to 400
 Increment: 1E-3
 *RST: 1.4
 Default unit: V

BUS:LIN:TECHnology <ThresholdType>

Sets the threshold value for digitization of signals according to the specified technology. If the signal value is higher than the threshold, the signal state is high. Otherwise, the signal state is considered low.

To set a user-defined threshold, select `USER` and define the value using `BUS:LIN:DATA:THReshold` on page 471.

Parameters:

<ThresholdType> TTL | ECL | CMOS | CAN | GND | LIN7vsupply | LIN12vsupply |
 LIN18vsupply | USER

CMOS
 2.5 V

LIN7vsupply | LIN12vsupply | LIN18vsupply
 7 V / 12 V / 18 V

USER
 Set the value with `BUS:LIN:DATA:THReshold`.

*RST: TTL

BUS:SETReflevels

Sets the appropriate threshold or threshold for the selected serial protocol.

Usage: Event

15.11.6.2 LIN Trigger

<code>TRIGger:LIN:CHKSError</code>	472
<code>TRIGger:LIN:DATA</code>	473
<code>TRIGger:LIN:DCONDition</code>	473
<code>TRIGger:LIN:ICONDition</code>	473
<code>TRIGger:LIN:IDENtifier</code>	473
<code>TRIGger:LIN:IPERror</code>	474
<code>TRIGger:LIN:SYERror</code>	474
<code>TRIGger:LIN:TYPE</code>	474

TRIGger:LIN:CHKSError <ChecksumError>

Triggers on a checksum error if `TRIGger:LIN:TYPE` is set to `ERRC`

Parameters:

<ChecksumError> ON | OFF
 *RST: ON

TRIGger:LIN:DATA <Pattern>

Defines the data pattern as trigger condition. Enter the words in MSB first bit order.

Parameters:

<Pattern> String with max. 4 bytes in binary format. Characters 0, 1, and X are allowed. If you define a pattern with incomplete byte, the missing LSB are filled with X.

Example:

```
TRIG:LIN:TYPE IDDT
TRIG:LIN:IDEN 001001
TRIG:LIN:ICON EQU
TRIG:LIN:DCON EQU
TRIG:LIN:DATA '11111111000000001111'
TRIG:LIN:DATA?
<-- 11111111000000001111XXXX
Triggers when the id '001001' and the data
'11111111000000001111' is detected in the measured signal
```

TRIGger:LIN:DCONDition <Relation>

Defines how the specified data pattern is compared with the acquired signal.

Parameters:

<Relation> EQUal | NEQual
 *RST: EQUal

TRIGger:LIN:ICONDition <Relation>

Defines how the specified identifier pattern is compared with the acquired signal. The instrument triggers if the acquired address is equal or unequal the defined pattern.

Parameters:

<Relation> EQUal | NEQual
 *RST: EQUal

TRIGger:LIN:IDENTifier <Pattern>

Specifies the identifier pattern to be found, in binary format. Enter the pattern in MSB first bit order.

Parameters:

<Pattern> String with max. 7 characters. Characters 0, 1, and X are allowed. If you define a pattern shorter than the pattern length, the missing LSB are filled with X.

Example:

```
TRIG:LIN:TYPE ID
TRIG:LIN:IDEN 001001
TRIG:LIN:ICON EQU
Triggers if the ID of the measured signal is 001001.
```

TRIGger:LIN:IPERror <ParityError>

Triggers on a parity error if `TRIGger:LIN:TYPE` is set to `ERRC`

Parameters:

```
<ParityError>      ON | OFF
*RST:              ON
```

TRIGger:LIN:SYERror <SyncError>

Triggers on a synchronization error if `TRIGger:LIN:TYPE` is set to `ERRC`

Parameters:

```
<SyncError>       ON | OFF
*RST:              ON
```

TRIGger:LIN:TYPE <TriggerType>

Parameters:

```
<TriggerType>     SYNC | WKFR | ERRC | ID | IDDT
```

SYNC

Triggers on the stop bit of the sync field.

WKFR

Triggers after a wakeup frame.

ERRC

Identifies various errors in the frame. You can select one or more error types as the trigger condition.

ID

Sets the trigger to a specific identifier or an identifier range.

IDDT

Sets the trigger to a combination of identifier and data condition. The instrument triggers at the end of the last byte of the specified data pattern.

```
*RST:              SYNC
```

15.11.6.3 LIN Decode Results

The frame suffix `<m>` selects the frame index for which the result is queried.

The byte suffix `<n>` selects the byte index for which the result is queried.

BUS:LIN:FCOunt?.....	475
BUS:LIN:FRAME<m>:BYTE<n>:STATe?.....	475
BUS:LIN:FRAME<m>:BYTE<n>:VALue?.....	475
BUS:LIN:FRAME<m>:CSSTate?.....	476
BUS:LIN:FRAME<m>:CSVAlue?.....	476
BUS:LIN:FRAME<m>:DATA?.....	476
BUS:LIN:FRAME<m>:IDPVAlue?.....	477
BUS:LIN:FRAME<m>:IDSTate?.....	477
BUS:LIN:FRAME<m>:IDVAlue?.....	477
BUS:LIN:FRAME<m>:START?.....	478
BUS:LIN:FRAME<m>:STOP?.....	478
BUS:LIN:FRAME<m>:STATus?.....	478
BUS:LIN:FRAME<m>:SYMBol?.....	478
BUS:LIN:FRAME<m>:SYSTate?.....	479

BUS:LIN:FCOunt?

Returns the number of decoded frames in the acquisition.

Return values:

<Count>	Range:	0 to 100000
	Increment:	1
	*RST:	0

Usage: Query only

BUS:LIN:FRAME<m>:BYTE<n>:STATe?

Returns the state of the specified byte.

Suffix:

<m>	*
<n>	*

Return values:

<ByteState>	OK STERror SPERror UVAL NOEXists INSufficient
	STERror: start error
	SPERror: stop error
	UVAL: unexpected value
	NOEXists: byte does not exist
	INSufficient: the frame is not completely contained in the acquisition. The decoded part of the frame is valid.
	*RST: OK

Usage: Query only

BUS:LIN:FRAME<m>:BYTE<n>:VALue?

Returns the value of the specified byte.

Suffix:

<m> *

<n> *

Return values:

<ByteValue> Range: 0 to 255
 *RST: 0

Usage: Query only**BUS:LIN:FRAME<m>:CSState?**

Returns the checksum state of the specified frame.

Suffix:

<m> *

Return values:

<ChecksumState> OK | STERror | SPERror | UVAL | NOEXists | INSufficient
 STERror: start error
 SPERror: stop error
 UVAL: unexpected value
 NOEXists: byte does not exist
 INSufficient: the frame is not completely contained in the acquisition. The decoded part of the frame is valid.
 *RST: OK

Usage: Query only**BUS:LIN:FRAME<m>:CSValue?**

Returns the checksum value of the specified frame.

Suffix:

<m> *

Return values:

<ChecksumValue> Range: 0 to 255
 *RST: 0

Usage: Query only**BUS:LIN:FRAME<m>:DATA?**

Returns the data bytes of the specified frame.

Suffix:

<m> *

Return values:

<Data> Comma-separated list of integer values (N, D1, D2,..., DN). N is the number of bytes in the frame, and D1...DN are the values of the bytes.

Example:

```
BUS:LIN:FRAME4:DATA?
<-- 4,118,39,71,123
```

Usage:

Query only

BUS:LIN:FRAME<m>:IDPValue?

Returns the value of the identifier parity bits of the selected frame.

Suffix:

<m> *

Return values:

<IdentifierParity> Range: 0 to 3
*RST: 0

Usage:

Query only

BUS:LIN:FRAME<m>:IDState?

Returns the identifier state of the selected frame.

Suffix:

<m> *

Return values:

<IdentifierState> OK | STERror | SPERror | PRERror | UVAL | NOEXists |
INSufficient
STERror: start error
SPERror: stop error
PRERror: parity error
UVAL: unexpected value
NOEXists: byte does not exist
INSufficient: the frame is not completely contained in the acquisition. The decoded part of the frame is valid.
*RST: OK

Usage:

Query only

BUS:LIN:FRAME<m>:IDValue?

Returns the identifier value of the selected frame.

Suffix:

<m> *

Return values:

<IdentifierValue> Range: 0 to 63
 *RST: 0

Usage: Query only

BUS:LIN:FRAME<m>:START?**BUS:LIN:FRAME<m>:STOP?**

Returns the start time and stop time of the selected frame, respectively.

Suffix:

<m> *

Return values:

<FrameStart> Range: -100E+24 to 100E+24
 <FrameStop> Increment: 100E-12
 *RST: 0
 Default unit: s

Usage: Query only

BUS:LIN:FRAME<m>:STATus?

Returns the overall state of the selected frame.

Suffix:

<m> *

Return values:

<FrameState> OK | WAKeup | SYERror | PRERror | CHCKsum | CPERror |
 INSufficient
 CHCKsum: checksum error
 PRERror: parity error in identifier
 SYERror: synchronization error
 WAKeup: the frame is a wakeup frame
 CPERror: parity error and checksum error
 INSufficient: the frame is not completely contained in the acquisition. The decoded part of the frame is valid.
 *RST: OK

Usage: Query only

BUS:LIN:FRAME<m>:SYMBol?

Returns the symbolic label of the specified frame if the label list is enabled.

Suffix:

<m> *

Return values:

<Label> String with symbolic name of the identifier

Example: BUS:LIN:FRAMe2:SYMBol?
Response: Temperature

Usage: Query only

BUS:LIN:FRAMe<m>:SYSTate?

Returns the synchronization state of the frame.

Suffix:
<m> *

Return values:
<FrameSyncState> OK | STERror | SPERror | PRERror | UVAL | NOEXists | INSufficient

OK
The frame is valid.

SPERror
Stop error, no stop condition found

STERror
Start error, no start condition found

PRERror
Parity error, which indicates a transmission error

UVAL
Unexpected value

NOEXists
Byte does not exist

INSufficient
The frame is not completely contained in the acquisition. The acquired part of the frame is valid.

*RST: OK

Usage: Query only

15.11.7 SENT (Option R&S RTH-K10)

- [SENT Configuration Settings](#)..... 479
- [SENT Trigger](#)..... 483
- [SENT Decode Results](#)..... 485

15.11.7.1 SENT Configuration Settings

BUS:SENT:DATA:SOURce.....	480
BUS:SENT:POLarity.....	480
BUS:SENT:TECHnology.....	480
BUS:SENT:DATA:THReshold.....	480
BUS:SENT:CLKPeriod.....	481
BUS:SENT:CLKTolerance.....	481

BUS:SENT:CRCHMethod.....	481
BUS:SENT:CRCHVersion.....	481
BUS:SENT:DNIBbles.....	481
BUS:SENT:PPFLength.....	482
BUS:SENT:PPULse.....	482
BUS:SENT:SFORmat.....	482
BUS:SENT:RDSL.....	482

BUS:SENT:DATA:SOURce <Channel>

Sets the source of the data line. All channel waveforms can be used.

Parameters:

<Channel> C1 | C2 | C3 | C4 | D0 | D1 | D2 | D3 | D4 | D5 | D6 | D7
 C3 and C4: only R&S RTH1004
 Digital channels are available if option R&S RTH-B1 is installed.
 *RST: C1

Usage: Asynchronous command

BUS:SENT:POLarity <Polarity>

Sets the idle state.

Parameters:

<Polarity> IDLLow | IDLHigh
 *RST: IDLHigh

BUS:SENT:TECHnology <ThresholdType>

Sets the threshold values as defined for various signal technologies.

Parameters:

<ThresholdType> CMOS | USER
 *RST: USER

BUS:SENT:DATA:THReshold <ThresholdValue>

Sets the threshold value for digitization of signals manually. If the signal value is higher than the threshold, the signal state is high. Otherwise, the signal state is considered low.

This value is only considered for [BUS:SENT:TECHnology](#) on page 480 [USER](#).

Parameters:

<ThresholdValue> Range: -400 to 400
 Increment: 1E-3
 *RST: 1.4
 Default unit: V

BUS:SENT:CLKPeriod <ClockPeriod>

Sets the nominal clock period (clock tick).

Parameters:

<ClockPeriod> Range: 1E-6 to 100E-6
 Increment: 1E-6
 *RST: 3E-6
 Default unit: s

BUS:SENT:CLKTolerance <ClockTolerance>

Sets a tolerated deviation of the clock signal.

Parameters:

<ClockTolerance> Range: 0 to 25
 Increment: 1
 *RST: 20
 Default unit: %

BUS:SENT:CRCMETHOD <CRCCalculation>

Selects the calculation method for the CRC checksum.

Parameters:

<CRCCalculation> SAEJ | TLE
 SAEJ: according to the standard
 TLE: according to the computing method for TLE_4998X sensors.
 *RST: SAEJ

BUS:SENT:CRCVersion <CRCVersion>

Selects the calculation method for the cyclic redundancy check (CRC).

Parameters:

<CRCVersion> V2010 | LEGA
 LEGAcY: method used up to 2010
 V2010: current method
 *RST: V2010

BUS:SENT:DNIBbles <DataNibbles>

Sets the number of data nibbles for a transmission sequence.

Parameters:

<DataNibbles> Range: 1 to 6
 Increment: 1
 *RST: 3

BUS:SENT:PPFLength <FrameLength>

Defines a constant transmission sequence length. To select the fixed sequence length, set `BUS:SENT:PPULse` to `PPFL`.

Parameters:

<FrameLength> Range: 104 to 922
 Increment: 1
 *RST: 128

BUS:SENT:PPULse <PausePulse>

Determines if a pause pulse is part of the SENT transmission sequence.

Parameters:

<PausePulse> NPP | PP | PPFL

PP

Transmits the message with a fixed pulse length, automatically calculated.

NPP

Transmits the SENT message without pause pulse.

PPFL

Transmits the pause pulse with a user-defined frame length to obtain a transmission sequence with constant length.

*RST: NPP

BUS:SENT:SFORmat <Format>

Selects the serial message format.

Parameters:

<Format> NONE | SHORt | ENHanced
 SHORt = Short serial message.
 ENHanced = Enhanced serial message.
 NONE = Single transmission sequence.
 *RST: NONE

BUS:SENT:RDSL <Display>

Selects the display table view mode for the SENT protocol.

Parameters:

<Display> TRSQ | SMSG
 TRSQ: fast channel
 SMSG: slow channel
 *RST: TRSQ

15.11.7.2 SENT Trigger

TRIGger:SENT:TYPE.....	483
TRIGger:SENT:DATA.....	483
TRIGger:SENT:DCondition.....	483
TRIGger:SENT:ICONdition.....	484
TRIGger:SENT:IDENtifier.....	484
TRIGger:SENT:SCONdition.....	484
TRIGger:SENT:STATus.....	484
TRIGger:SENT:FCRCError.....	484
TRIGger:SENT:IRFLength.....	485
TRIGger:SENT:PPERioderror.....	485
TRIGger:SENT:PULSeerror.....	485
TRIGger:SENT:SCRCError.....	485

TRIGger:SENT:TYPE <TriggerType>

Sets the SENT trigger type.

Parameters:

<TriggerType>	STOF STAT STDA ID IDDT ERRC
	STOF:
	STAT: fast status
	STDA: fast status and data
	ID: slow Identifier
	IDDT: slow Identifier and data
	ERRC: error condition
	*RST: STOF

TRIGger:SENT:DATA <Pattern>

Defines the data pattern as trigger condition. Enter the words in MSB first bit order.

Parameters:

<Pattern>	String with max. 4 bytes in binary format. Characters 0, 1, and X are allowed. If you define a pattern with incomplete byte, the missing LSB are filled with X.
-----------	---

TRIGger:SENT:DCondition <Relation>

Defines how the specified data pattern is compared with the acquired signal. The instrument triggers if the acquired address is equal or unequal the defined pattern.

Parameters:

<Relation>	UNUSed EQUal NEQual LTHan LETHan GTHan GETHan INRange OORange
	*RST: EQUal

TRIGger:SENT:ICONdition <Relation>

Defines how the specified identifier pattern is compared with the acquired signal. The instrument triggers if the acquired address is equal or unequal the defined pattern.

Parameters:

<Relation> UNUSed | EQUal | NEQual | LTHan | LETHan | GTHan |
 GETHan | INRange | OORange
*RST: EQUal

TRIGger:SENT:IDENTifier <Pattern>

Specifies the identifier pattern to be found, in binary format. Enter the pattern in MSB first bit order.

Parameters:

<Pattern> String with max. 7 characters. Characters 0, 1, and X are
 allowed. If you define a pattern shorter than the pattern length,
 the missing LSB are filled with X.

TRIGger:SENT:SCONdition <Relation>

Defines how the specified status pattern is compared with the acquired signal. The instrument triggers if the acquired address is equal or unequal the defined pattern.

Parameters:

<Relation> UNUSed | EQUal | NEQual | LTHan | LETHan | GTHan |
 GETHan | INRange | OORange
*RST: EQUal

TRIGger:SENT:STATus <Pattern>

Defines the status pattern as trigger condition. Enter the words in MSB first bit order.

Parameters:

<Pattern>

TRIGger:SENT:FCRCerror <FastCRCError>

Triggers on a detected CRC error in the transmission sequences of the fast channel. The CRC length is 4 bits.

Parameters:

<FastCRCError> ON | OFF
*RST: ON

TRIGger:SENT:IRFLength <FrameLengthError>

Triggers on frame length errors in transmission sequences, if `BUS:SENT:PPULse` is set to `PPFL`. A frame length error occurs, when the total length of the transmission sequence (including pause pulse) does not match the frame length set with `BUS:SENT:PPFLength`.

Parameters:

<FrameLengthError> ON | OFF
*RST: ON

TRIGger:SENT:PPERioderror <PulsePeriodError>

Triggers on an error in the calibration/sync pulse in transmission sequences of the fast channel.

Parameters:

<PulsePeriodError> ON | OFF
*RST: ON

TRIGger:SENT:PULSeerror <SyncPulseError>

Triggers on a synchronization/calibration pulse error in transmission sequences of the fast channel.

Parameters:

<SyncPulseError> ON | OFF
*RST: ON

TRIGger:SENT:SCRCerror <SlowCRCErrror>

Triggers on a detected CRC error in serial messages of the slow channel. The CRC length is 4 bits for short serial messages, and 6 bit of enhanced serial messages.

Parameters:

<SlowCRCErrror> ON | OFF
*RST: ON

15.11.7.3 SENT Decode Results

The frame suffix <m> selects the frame index for which the result is queried.

The byte suffix <n> selects the byte index for which the result is queried.

<code>BUS:SENT:FCOunt?</code>	486
<code>BUS:SENT:FRAME<m>:CSValue?</code>	486
<code>BUS:SENT:FRAME<m>:DATA?</code>	486
<code>BUS:SENT:FRAME<m>:DStatus?</code>	487
<code>BUS:SENT:FRAME<m>:IDTYpe?</code>	487
<code>BUS:SENT:FRAME<m>:IDValue?</code>	487

BUS:SENT:FRAME<m>:NIBBLE<n>:STATE?	488
BUS:SENT:FRAME<m>:NIBBLE<n>:VALUE?	488
BUS:SENT:FRAME<m>:PAPTICKS?	488
BUS:SENT:FRAME<m>:SCOM?	488
BUS:SENT:FRAME<m>:SDATA?	489
BUS:SENT:FRAME<m>:START?	489
BUS:SENT:FRAME<m>:STATUS?	489
BUS:SENT:FRAME<m>:STOP?	490
BUS:SENT:FRAME<m>:SYMBOL?	490
BUS:SENT:FRAME<m>:SYNCDURATION?	490
BUS:SENT:FRAME<m>:TYPE?	491

BUS:SENT:FCOUNT?

Returns the number of decoded frames.

Return values:

<Count> Total number of decoded frames.
 Range: 0 to 100000
 Increment: 1
 *RST: 0

Usage: Query only

BUS:SENT:FRAME<m>:CSVALUE?

Returns the CRC sequence value of the selected frame.

Suffix:

<m> *

Return values:

<ChecksumValue> The values below – range, increment and reset – are decimal values.
 Range: 0 to 63
 Increment: 1
 *RST: 0

Usage: Query only

BUS:SENT:FRAME<m>:DATA?

Returns the data of the specified frame.

Suffix:

<m> *
 Selects the frame.

Parameters:

<Data> Comma-separated sequence of integer values (N, D1, D2,..., DN). N is the number of nibbles in the frame and thus the number of following values. D1...DN are the values of the nibbles.

Example: BUS:SENT:FRAMe4:DATA?
 <-- 4,3,15,11,9
 Returns the data of the 4th frame: the number of nibbles is 4, followed by the data values.

Usage: Query only

BUS:SENT:FRAMe<m>:DSTatus?

Returns the status of the frame.

Suffix:
 <m> *

Return values:
 <FrameState> OK | TMSE | SDIF | CRC | PAUSe | NEG | TCERror | SCERror |
 SPERror | SNERror | CPERror | CNERror | PNERror | SCPE |
 SCNE | SPNE | CPNE | SCPN | SLENgth | NLENgth |
 INSufficient
 *RST: OK

Usage: Query only

BUS:SENT:FRAMe<m>:IDTYpe?

Returns the identifier type of the selected frame.

Suffix:
 <m> *

Return values:
 <FrameIdentifierType>NONE | B4 | B8
 B4: standard format, 4 bit
 B8: extended format, 8 bit
 *RST: B4

Usage: Query only

BUS:SENT:FRAMe<m>:IDValue?

Returns the identifier value of the selected frame.

Suffix:
 <m> *

Return values:
 <IdentifierValue> The values below – range, increment and reset – are decimal values.
 Range: 0 to 255
 Increment: 1
 *RST: 0

Usage: Query only

BUS:SENT:FRAME<m>:NIBBLE<n>:STATE?

Returns the state of the specified nibble.

Suffix:

<m> *

<n> *

Return values:

<FrameNibbleState> OK | UNDF
 UNDF = Undefined
 *RST: OK

Usage: Query only

BUS:SENT:FRAME<m>:NIBBLE<n>:VALue?

Returns the value of the specified nibble.

Suffix:

<m> *

<n> *

Return values:

<FrameNibbleValue> The values below – range, increment and reset – are decimal values.
 Range: 0 to 15
 Increment: 1
 *RST: 0

Usage: Query only

BUS:SENT:FRAME<m>:PAPTicks?

Returns the number of the pulse pause clock ticks.

Suffix:

<m> *

Return values:

<PausePulseTicks> Range: 12 to 768
 Increment: 1
 *RST: 12

Usage: Query only

BUS:SENT:FRAME<m>:SCOM?

Returns the value of the status/communication pulse.

Suffix:
<m> *

Return values:
<StatusCommunication> Range: 0 to 0
Increment: 1
*RST: 0

Usage: Query only

BUS:SENT:FRAME<m>:SDATa?

Returns the symbolic data of the frame.

Suffix:
<m> *

Return values:
<SymbolicData> Comma-separated list of values. The first value is the number of bytes, followed by the decoded data bytes.

Usage: Query only

BUS:SENT:FRAME<m>:START?

Returns the start time of the selected frame.

Suffix:
<m> *

Return values:
<FrameStart> Range: -100E+24 to 100E+24
Increment: 100E-12
*RST: 0
Default unit: s

Usage: Query only

BUS:SENT:FRAME<m>:STATUs?

Returns the overall state of the selected frame.

Suffix:
<m> *

Return values:
<FrameState> OK | SYNC | PULSe | CRC | IRFL | FORM | INSufficient

OK: The frame is valid.
 SYNC: Synchronization error occurred.
 PULSe: Pulse error occurred.
 CRC: Cyclic redundancy check failed.
 IRFL: Irregular frame length error occurred.
 FORM: Format error occurred.

INSufficient: The frame is not completely contained in the acquisition. The acquired part of the frame is valid.

*RST: OK

Usage: Query only

BUS:SENT:FRAME<m>:STOP?

Returns the stop time of the selected frame.

Suffix:

<m> *

Return values:

<FrameStop> Range: -100E+24 to 100E+24
 Increment: 100E-12
 *RST: 0
 Default unit: s

Usage: Query only

BUS:SENT:FRAME<m>:SYMBOL?

Returns the symbolic label of the specified frame if the label list is enabled.

Suffix:

<m> *

Return values:

<Translation> String with symbolic label of the identifier.

Example:

BUS:SENT:FRAME:SYMBOL?
 Response: Air Temperature

Usage: Query only

BUS:SENT:FRAME<m>:SYNCduration?

Returns the time of the synchronization pulse.

Suffix:

<m> *

Return values:

<SyncDuration> Range: 28E-6 to 8.4E-3
 Increment: 1E-6
 *RST: 168E-6
 Default unit: s

Usage: Query only

BUS:SENT:FRAME<m>:TYPE?

Returns the type of SENT message.

Suffix:

<m> *

Return values:

<FrameType> TRSQ | SMSG | EMSG
 TRSQ = transmission sequence
 SMSG = short serial message
 EMSG = enhanced serial message
 *RST: TRSQ

Usage: Query only

15.12 Logic Analyzer (R&S RTH-B1 MSO)

LOGic:STATe.....	491
LOGic:THCoupling.....	491
LOGic:GROup<m>:TECHnology.....	492
LOGic:GROup<m>:USER.....	492
LOGic:GROup<m>:THReshold?.....	493
LOGic:GROup<m>:HYSTeresis.....	493
LOGic:CHANnel<m>:DESKew.....	493
POD:STATe?.....	494

LOGic:STATe <State>

Enables or disables the logic channels.

Parameters:

<State> ON | OFF
 *RST: OFF

LOGic:THCoupling <ThresCoup>

Couples the threshold and hysteresis settings for the logic channels.

If enabled, all logic channels use the same threshold and hysteresis settings.

If disabled, 2 channel groups are available, which can use different threshold and hysteresis settings: D0 - D3, and D4 - D7.

Parameters:

<ThresCoup> ON | OFF
 *RST: ON

LOGic:GROup<m>:TECHnology <ThresholdType>

Sets the threshold value for the selected channel group, or for all logic channels.

Suffix:

<m> 1..3
 1 = all logic channels D0 to D7
 2 = group D0 to D3
 3= group D4 to D7
 The suffix only takes effect if **LOGic:THCoupling** is OFF.

Parameters:

<ThresholdType> TTL | ECL | CMOS | CAN | GND | LIN7vsupply | LIN12vsupply | LIN18vsupply | USER

TTL
 1.4 V

ECL
 -1.3 V

CMOS
 2.5 V

GND
 0 V (for CAN channels, requires option R&S RTH-K3)

CAN
 2 V (for CAN channels, requires option R&S RTH-K3)

LIN7vsupply | LIN12vsupply | LIN18vsupply
 7 V / 12 V / 18 V (for LIN channels, requires option R&S RTH-K3)

12 V Supply
 12 V (for LIN channels, requires option R&S RTH-K3)

18 V Supply
 18 V (for LIN channels, requires option R&S RTH-K3)

USER
 Set the value with **LOGic:GROup<m>:USER**.

*RST: TTL

LOGic:GROup<m>:USER <ThresholdValue>

Sets the threshold value if **LOGic:GROup<m>:TECHnology** is set to USER.

Suffix:

<m> 1..3
 1 = all logic channels D0 to D7
 2 = group D0 to D3
 3= group D4 to D7
 The suffix only takes effect if **LOGic:THCoupling** is OFF.

Parameters:

<ThresholdValue> Range: -400 to 400
 Increment: 1E-3
 *RST: 1.4
 Default unit: V

LOGic:GROup<m>:THReshold?

Returns the current threshold value.

Suffix:

<m> 1..3
 1 = all logic channels D0 to D7
 2 = group D0 to D3
 3= group D4 to D7

Return values:

<Level> Range: -10 to 10
 Increment: 1E-3
 *RST: 0
 Default unit: V

Usage: Query only

LOGic:GROup<m>:HYSTeresis <Hysteresis>

Hysteresis avoids the change of signal states due to noise oscillation around the threshold level. Set a small hysteresis for clean signals, and large hysteresis for noisy signals.

Suffix:

<m> 1..3
 1 = all logic channels D0 to D7
 2 = group D0 to D3
 3= group D4 to D7
 The suffix only takes effect if `LOGic:THCoupling` is OFF.

Parameters:

<Hysteresis> SMALl | MEDium | LARGe
 *RST: MEDium

LOGic:CHANnel<m>:DESKew <Value>

Sets the deskew for all channels of a logic probe at once, or for each logic channel separately.

Suffix:

<m> 1..9
 1..8: logic channels 0 to 7
 9: all logic channels

Parameters:

<Value> Range: -100E-9 to 100E-9
 Increment: 800E-12
 *RST: 0
 Default unit: s

Example:

```
LOGic:CHANnel9:DESKew 0.00000001
LOGic:CHANnel8:DESKew 0.00000002
LOGic:CHANnel1:DESKew?
<-- 1e-08
LOGic:CHANnel8:DESKew?
<-- 2e-08
```

POD:STATe?

Returns the connection state of the logic probe.

Return values:

<PODConnected> ON | OFF
 *RST: OFF

Usage: Query only

15.13 Documenting Results

15.13.1 Export of Waveform Data to File

The commands described in this chapter write the sample data of active waveforms to one or more CSV files.

The resulting files are described in [Chapter 12.4.3, "Waveform Export Files"](#), on page 276.



To export the results of a harmonics measurement, see [Chapter 15.6.3.2, "Retrieving and Exporting Harmonic Results"](#), on page 376.

Example: Saving a single waveform with time values

The example program saves the data of channel 1 to a file on the SD card. Voltage and time values are saved. Then the data is read and deleted.

```
:EXPort:WAVEform:NAME '/media/SD/Waveform.csv'
:EXPort:WAVEform:SOURce C1
:EXPort:WAVEform:INCXvalues 1                   // include time values
:EXPort:WAVEform:DLOGging 0                   // without history
:EXPort:WAVEform:SAVE ;*OPC
:MMEMory:DATA? '/media/SD/Waveform.csv'
:MMEMory:DELeTe '/media/SD/Waveform.csv';*OPC
```

Example: Saving all active waveforms with time values

The example program saves the voltage and time values of all active analog, digital and math waveforms. Then the data is read and deleted.

```
:EXPort:WAVeform:NAME '/media/SD/Multiwfm.csv'
:EXPort:WAVeform:MULTichannel 1
:EXPort:WAVeform:INCXvalues 1 // include time values
:EXPort:WAVeform:DLOGging 0 // without history
:EXPort:WAVeform:SAVE ;*OPC
:MMEMory:DATA? '/media/SD/Multiwfm.csv'
:MMEMory:DELeTe '/media/SD/Multiwfm.csv';*OPC
```

Example: Saving history data of channel 1, without time values

The example program saves the history data of selected segments to a file on the SD card. Then the data is read and deleted.

```
:EXPort:WAVeform:NAME '/media/SD/WaveformHistory.zip'
:EXPort:WAVeform:SOURce C1
:EXPort:WAVeform:INCXvalues 0 // no time values
:EXPort:WAVeform:DLOGging 1 // include history
:CHANnel1:HISTory:START -77 // select segment range (optional)
:CHANnel1:HISTory:STOP -5
:EXPort:WAVeform:SAVE ;*OPC
:MMEMory:DATA? '/media/SD/WaveformHistory.zip'
:MMEMory:DELeTe '/media/SD/WaveformHistory.zip';*OPC
```

EXPort:WAVeform:NAME.....	495
EXPort:WAVeform:SOURce.....	495
EXPort:WAVeform:MULTichannel.....	496
EXPort:WAVeform:INCXvalues.....	496
EXPort:WAVeform:DLOGging.....	496
EXPort:WAVeform:SAVE.....	497

EXPort:WAVeform:NAME <Name>

Sets the file name, file format and path to save the waveform to.

Parameters:

<Name> String with path and file name with extension .csv or .zip.

Example:

```
EXPort:WAVeform:NAME
'/media/SD/Export/Export_Ch2.csv'
EXPort:WAVeform:SAVE
Saves the waveform data to Export/Export_Ch2.csv on the
SD card.
```

EXPort:WAVeform:SOURce <Source>

Selects the waveform to be exported if `EXPort:WAVeform:MULTichannel` is OFF.

Parameters:

<Source> C1 | C2 | C3 | C4 | M1 | D0 | D1 | D2 | D3 | D4 | D5 | D6 | D7
 D0 | D1 | D2 | D3 | D4 | D5 | D6 | D7: All active logic channels are saved, not matter which Dx is specified in the command.
 *RST: C1

EXPort:WAVeform:MULTichannel <MultiChExport>

If ON, all active waveforms (analog, digital and math) are exported.

If OFF, select the waveform for export with [EXPort:WAVeform:SOURce](#).

Parameters:

<MultiChExport> ON | OFF
 ON = 1, and OFF = 0
 *RST: ON

Example: See [Example "Saving all active waveforms with time values"](#) on page 495.

EXPort:WAVeform:INCXvalues <IncHorValues>

Includes horizontal values in the export data (time values).

Parameters:

<IncHorValues> ON | OFF
 ON = 1, and OFF = 0
 *RST: OFF

Example: See [Example "Saving a single waveform with time values"](#) on page 494.

EXPort:WAVeform:DLOGging <DataLogging>

The command requires option R&S RTH-K15. History must be enabled before using the command ([CHAN:HIST:STAT ON](#)).

The command includes the history data in the export files. If acquisition is running, the command stops the acquisition.

History data is always saved in a zip file (compressed csv), see also [Chapter 4.7.4, "Exporting History Data"](#), on page 103.

You can select a range of history segments with [CHANnel<m>:HISTory:START](#) and [CHANnel<m>:HISTory:STOP](#).

Parameters:

<DataLogging> ON | OFF
 ON = 1, and OFF = 0
 *RST: OFF

Example: See [Example "Saving history data of channel 1, without time values"](#) on page 495.

EXPort:WAVeform:SAVE

Saves the waveform(s) to the file specified with `EXPort:WAVeform:NAME`.

Example: See [Example "Saving a single waveform with time values"](#) on page 494.

Usage: Event

15.13.2 Transfer of Waveform Data

Data conversion of integer values if `FORMat:DATA INT,16` is used

To convert INT16 data to physical quantities, e.g. voltages, use the following formulas:

$$\text{PhysicalQuantity} = (\text{Value_ADC} * \text{ConversionFactor}) + \text{VerticalOffset}_{\text{eff}}$$

$$\text{ConversionFactor} = \text{VerticalScale} * \text{VerticalDivisionCount} / \text{NofQuantisationLevels}$$

$$\text{VerticalOffset}_{\text{eff}} = \text{VerticalOffset} - \text{VerticalPosition} * \text{VerticalScale}$$

Table 15-1: Data conversion example

VerticalScale	0.05 V/div
VerticalOffset	0.1 V
VerticalPosition	1 div
NofQuantisationLevels	255 * 256
VerticalDivisionCount	8
Value_ADC	-61
ConversionFactor	$0.05 * 8 / (255 * 256) = 0.000006127451 \text{ V}$
VerticalOffset _{eff}	$0.1 - 1 * 0.05 = 0.05 \text{ V}$
Voltage	$(-61 * 0.000006127451 \text{ V}) + 0.05 \text{ V} = -0.32 \text{ mV}$

The values are read with `CHANnel<m>:DATA[:VALues]?`.

To get the vertical scale, position and offset, you can use the appropriate commands:

- `CHANnel<m>:SCALE` on page 305
- `CHANnel<m>:POSITION` on page 307
- `CHANnel<m>:OFFSET` on page 307

You can find these values also in the data export file, see [Chapter 15.13.1, "Export of Waveform Data to File"](#), on page 494.

FORMat[:DATA] <Format>

Sets the data type that is used for transmission of waveform data from the instrument to the controlling computer.

Waveform data can be retrieved using the following command: [CHANnel<m>:DATA\[:VALues\]?](#) on page 499

Parameters:

<Format>

AScii | INT,16

AScii

Data values are returned in ASCII format as a list of comma separated values in floating point format. The length can be omitted. It is 0 which means that the instrument selects the number of digits to be returned. The query returns both values (ASC, 0).

INT,16

Signed integer data with length 16 bit. It defines that [CHANnel<m>:DATA\[:VALues\]?](#) returns the raw sample data of the ADC as integers. If format of the waveform data differs from the defined export format, the instrument converts the data to the required format.

The schema of the result string is as follows:

```
#41024<value1><value2>...<value n> with:
```

```
#4 = number of digits (= 4 in the example) of the following number
```

```
1024 = number of following data bytes (= 1024 in the example)
```

```
<value> = 4-byte floating point values
```

You can also set the byte order using the [FORMat:BORDER](#) command.

Data conversion is described in "[Data conversion of integer values if FORMat:DATA INT,16 is used](#)" on page 497.

```
*RST:      AScii
```

Example:

```
FORMat:DATA INT,16
```

```
FORMat:DATA?
```

```
<-- INT,16
```

Usage:

SCPI confirmed

FORMat:BORDER <ByteOrder>

Sets the endianness if [FORMat\[:DATA\]](#) is set to INT,16.

Parameters:

<ByteOrder>

MSBFirst | LSBFirst

LSBFirst: little endian, least significant byte first

MSBFirst: big endian, most significant byte first

```
*RST:      LSBFirst
```

CHANnel<m>:DATA:HEADer?

Returns the header of channel waveform data.

Table 15-2: Header data

Position	Meaning	Example
1	XStart in s	-5e-07 = -5 ns
2	XStop in s	5e-07 = 5 ns
3	Record length of the waveform, number of samples	2500
4	Number of values per sample interval. For most waveforms the result is 1, for peak detect and envelope waveforms it is 2. If the number is 2, the number of returned values is twice the record length.	2

Suffix:

<m> 1|2 (RTH1002) , 1..4 (RTH1004)

Example:

```
CHAN1:DATA:HEAD?
-5e-07,5e-07,2500,2
CHANnel1:DATA? returns 5000 values.
```

Usage:

Query only
SCPI confirmed

CHANnel<m>:DATA[:VALues]?

Returns the data of the channel waveform points for transmission from the instrument to the controlling computer. The data can be used in MATLAB, for example.

To set the data format, use **FORMat [:DATA]** on page 498

Suffix:

<m> 1|2 (RTH1002) , 1..4 (RTH1004)

Return values:

<Data> List of values according to the format

Example:

```
FORM ASC
CHAN2:DATA?
<-- -0.125000,-0.123016,-0.123016,-0.123016,
-0.123016,-0.123016,...
```

Usage:

Query only

15.13.3 Screenshots

The example program creates a screenshot and saves it to a file on the SD card. Then the screenshot data is read and deleted.

```
:HCOPY:LANGuage PNG
:MMEMory:NAME '/media/SD/Screenshot.png'
```

```

:HCOPy:IMMEDIATE;*OPC
:MMEMory:DATA? '/media/SD/Screenshot.png'
:MMEMory:DELeTe '/media/SD/Screenshot.png';*OPC

```

HCOPy:LANGUage.....	500
HCOPy:COLor.....	500
HCOPy:INVerse.....	500
MMEMory:NAME.....	500
HCOPy:IMMEDIATE.....	500

HCOPy:LANGUage <FileFormat>

Defines the format of the screenshot file.

Parameters:

<FileFormat> PNG | JPG | BMP | TIFF
 *RST: PNG

HCOPy:COLor <BlackWhite>

Creates a black and white screenshot.

Parameters:

<BlackWhite> ON | OFF
 *RST: OFF

HCOPy:INVerse <InverseColor>

Inverts the colors of the output, i.e. a dark waveform is printed on a white background.

Parameters:

<InverseColor> ON | OFF
 *RST: OFF

MMEMory:NAME <Filename>

Defines the filename of the next screenshot.

Parameters:

<Filename> String with the filename

HCOPy:IMMEDIATE

Saves the current display in a new screenshot.

Usage: Event

15.13.4 Instrument Settings, MMEM Commands

The Mass MEMory subsystem provides commands to access the storage media and to save and reload instrument settings.

File and directory names

The <file_name> and <directory_name> parameters are strings. If no complete path is specified, the file location is relative to the current directory, queried with `MMEMory:CDIRectory?`. The file name itself may contain the period as a separator for extensions.

File and directory names can be chosen according to Windows™ conventions. All letters and numbers are allowed, as well as the special characters "_", "^", "\$", "~", "!", "#", "%", "&", "-", "{", "}", "(", ")", "@", and "'". Reserved file names are CON, AUX, COM1, ..., COM4, LPT1, ..., LPT3, NUL and PRN.

<code>MMEMory:SAV</code>	501
<code>MMEMory:RCL</code>	501
<code>MMEMory:DATA</code>	502
<code>MMEMory:CDIRectory</code>	502
<code>MMEMory:MDIRectory</code>	502
<code>MMEMory:RDIRectory</code>	503
<code>MMEMory:DCATalog?</code>	503
<code>MMEMory:DCATalog:LENGth?</code>	504
<code>MMEMory:CATalog?</code>	504
<code>MMEMory:CATalog:LENGth?</code>	505
<code>MMEMory:COPY</code>	505
<code>MMEMory:MOVE</code>	505
<code>MMEMory:DELeTe</code>	506

MMEMory:SAV <FileDestination>

Stores the current instrument settings to the specified file.

Parameters:

<FileDestination> String parameter specifying path and filename of the target file. Wildcards are not allowed.

Example:

```
MMEM:SAV
"/media/SD/Rohde-Schwarz/RTH/SaveSets/SetupMeasA.dfl"
Saves the current instrument settings to the file
SetupMeasA.dfl located in the directory /media/SD/
Rohde-Schwarz/RTH/SaveSets/ on the microSD card.
```

Usage: Event

MMEMory:RCL <FileDestination>

Restores the instrument settings from the specified file.

Parameters:

<FileDestination> String parameter specifying path and filename of the settings file. Wildcards are not allowed.

Example:

```
MMEM:RCL
"/media/SD/Rohde-Schwarz/RTH/SaveSets/SetupMeasA.dfl"
Loads and activates the instrument settings from the file
SetupMeasA.dfl located in the directory /media/SD/
Rohde-Schwarz/RTH/SaveSets/ on the microSD card.
```

Usage:

Event

MMEMory:DATA <FileName>,<Data>

Writes data to the specified file in the current directory (MMEMory:CDIRectory), or reads the data.

Parameters:

<Data> 488.2 block data
The block begins with character '#'. The next digit is the length of the length information. Then the length information digits provide the number of bytes in the binary data.

Parameters for setting and query:

<FileName> String parameter containing the file name

Example:

```
MMEM:DATA "abc.txt", #216This is the file
#2: the length information has two digits
16: the binary data has 16 bytes.
MMEM:DATA? "abc.txt"
received: This is the file
```

MMEMory:CDIRectory <DirectoryName>

Specifies the current directory for file access.

Setting parameters:

<DirectoryName> String parameter to specify the directory.

Example:

```
MMEM:CDIR "/media/USB1/Data";*OPC
```

MMEMory:MDIRectory <DirectoryName>

Creates a new directory with the specified name.

Setting parameters:

<DirectoryName> String parameter
Absolute path, or path relative to the current directory.

Example:

```
Create directory Data on the USB flash device using absolute
path:
MMEM:MDIR "/media/USB1/Data"
```

Usage: Setting only

MMEMory:RDIRectory <DirectoryName>

Deletes the specified directory.

Note: All subdirectories and all files in the specified directory and in the subdirectories are deleted!

You cannot delete the current directory or a superior directory. In this case, the instrument returns an execution error.

Setting parameters:

<DirectoryName> String parameter, absolute path or relative to the current directory

Example: `MMEM:RDIR "/media/USB1/Screenshots"`
Deletes the directory `Screenshots` on the USB flash drive.

Usage: Setting only

MMEMory:DCATalog? <DirectoryName>

Returns the subdirectories of the specified directory. The result corresponds to the number of strings returned by the `MMEMory:DCATalog:LENGth?` command.

Query parameters:

<DirectoryName> String parameter
Specifies the directory.

Return values:

<FileEntry> String parameter
List of subdirectory strings separated by commas. The current and the parent directories are also returned ("`.,,0`", "`.,.,,0`").

Example: Query for directories using absolute path:
`MMEM:DCAT? "/media/USB1/*"`
received "`.,,0`", "`.,.,,0`", "`Export,,0`", "`SaveSets,,0`", "`SCREENSHOTS,,0`"
`MMEM:DCAT:LENG? "/media/USB1/*"`
received 5

Example: Query for directories in the current directory:
`MMEM:CDIR "/media/USB1/"`
`MMEM:DCAT? "*"`
received "`.,,0`", "`.,.,,0`", "`JANUARY,,0`", "`FEBRUARY,,0`"
`MMEM:DCAT:LENG? "*"`
received 4

Example: Query for directories starting with S using filter:

```
MMEM:DCAT? "/media/USB1/S*"
received "SaveSets,,0","Slots,,0"
MMEM:DCAT:LENG? "/media/USB1/S*"
received 2
```

Usage: Query only

MMEMory:DCATalog:LENGth? <DirectoryName>

Returns the number of directories in specified directory. The result corresponds to the number of strings returned by the `MMEMory:DCATalog?` command.

Query parameters:

<DirectoryName> String parameter
Specifies the directory.

Return values:

<FileEntryCount> Number of directories.

Example:

```
MMEMory:DCATalog:LENGth
"/media/SD/Rohde-Schwarz/RTH"
recieved: 12
```

Usage: Query only

MMEMory:CATalog? <DirectoryName>[,<Format>]

Returns the a list of files contained in the specified directory. The result corresponds to the number of files returned by the `MMEMory:CATalog:LENGth?` command.

The list of return values has the following order:

<UsedMemory>,<FreeMemory>,<FileEntry1>,<FileEntry2>,...

Query parameters:

<DirectoryName> String parameter
Specifies the directory. A filter can be used to list, for example, only files of a given file type.

<Format> ALL | WTIME
ALL: Extended result including file, date, time and attributes
WTIME: Result including file, date, time

Return values:

<UsedMemory> Total amount of storage currently used in the directory, in bytes.

<FreeMemory> Total amount of storage available in the directory, in bytes.

<FileEntry> String parameter
All files of the directory are listed with their file name, format and size in bytes.

- Example:** Query for files in the SaveSets directory on the USB flash drive using absolute path:
 MMEM:CAT? "/media/USB1/SaveSets/*.*"

received: 511104,8633856,"Settings_Mon.xml,,8",

"Settings_Tue.xml,,8"
- Example:** Query for files that start with Settings in a user-defined directory on the USB flash drive:
 MMEM:CAT? "/media/USB1/Misc/Settings*.*"

received: 511104,8633856,"Settings_160321.xml,,8",

"Settings_160322.xml,,8"
- Usage:** Query only

MMEMory:CATalog:LENGth? <DirectoryName>

Returns the number of files in the specified directory. The result corresponds to the number of files returned by the `MMEMory:CATalog?` command.

Query parameters:

<PathName> String parameter
 Directory to be queried, absolute or relative path

Return values:

<Count> Number of files.

Usage: Query only

MMEMory:COpy <FileSource>,<FileDestination>

Copies data to another directory on the same or different storage device. The file name can be changed, too.

Setting parameters:

<FileSource> String parameter
 Name and path of the file to be copied

<FileDestination> String parameter
 Name and path of the new file. If the file already exists, it is overwritten without notice.

Example: MMEM:COpy "/media/SD/Rohde-Schwarz/RTH/SaveSets/Settings1.xml",

"/media/USB1/SaveSets/Settings1.xml"

Usage: Setting only

MMEMory:MOve <FileSource>, <FileDestination>

Moves an existing file to a new location.

Setting parameters:

<FileSource> String parameter
Path and name of the file to be moved.

<FileDestination> String parameter
Path and name of the new file.

Example: `MMEM:MOVE "/media/SD/Rohde-Schwarz/RTH/SaveSets/Settings1.xml",
"/media/USB1/SaveSets/Settings1.xml"`

Usage: Setting only

MMEMory:DELeTe <FileSource>

Removes a file from the specified directory.

Setting parameters:

<FileSource> String parameter
File name and path of the file to be removed. If the path is omitted, the specified file is deleted in the current directory. Filters are not allowed.

Example: `MMEM:DELeTe "/media/USB1/SaveSets/Settings1.xml"`

Usage: Setting only

15.14 General Instrument Setup

- [Date and Time](#).....506
- [Display Settings](#)..... 507

15.14.1 Date and Time

SYSTem:DATE [<Year>], [<Month>], [<Day>]

SYSTem:DATE? [<Year>], [<Month>]

Sets the date on the instrument.

Parameters:

<Day> Range: 1 to 31
Increment: 1
*RST: 1

Parameters for setting and query:

<Year> Range: 2012 to 2099
Increment: 1
*RST: 2012

<Month> Range: 1 to 12
 Increment: 1
 *RST: 1

SYSTem:TIME [<Hours>], [<Minutes>], [<Seconds>]

SYSTem:TIME? [<Hours>], [<Minutes>]

Sets the time on the instrument.

Parameters:

<Seconds> Range: 0 to 59
 Increment: 1
 *RST: 1

Parameters for setting and query:

<Hours> Range: 0 to 24
 Increment: 1
 *RST: 1

<Minutes> Range: 0 to 59
 Increment: 1
 *RST: 1

15.14.2 Display Settings

DISPlay:PERsistence[:TYPE].....	507
DISPlay:PERsistence:TIME.....	508
DISPlay:CONTRast.....	508
DISPlay:MOUS.....	508
DISPlay:LCD.....	508

DISPlay:PERsistence[:TYPE] <PersistenceType>

Defines how long every new data point remains on the screen.

Parameters:

<PersistenceType> OFF | OFFM | TIME | INF

OFF

Deactivates persistence and displays the last acquisition.

OFFM

Deactivates persistence and displays multiple acquisitions.

TIME

Data points remain on the screen for the duration defined with [DISPlay:PERsistence:TIME](#).

INF

Data points remain on the screen infinitely until persistence is set to OFF.

*RST: OFF

DISPlay:PERSistence:TIME <PersistenceTime>

Sets a user-defined persistence time. The command takes effect if **DISPlay:PERSistence[:TYPE]** is set to **TIME**.

Parameters:

<PersistenceTime> Range: 0.05 to 10
 Increment: 0.01
 *RST: 0.05
 Default unit: s

DISPlay:CONTRast <ContrastMode>

If enabled, the waveforms are displayed in black color on white background.

Parameters:

<ContrastMode> ON | OFF
 *RST: OFF

DISPlay:MOUS <EnableTouch>

Switches the touch functionality of the screen on or off.

If you use the instrument in an environment with immissions considerably higher than specified, the immissions may affect the touch sensitivity of the screen. In this case, disable the touch and operate the instrument using the keys and the wheel.

Parameters:

<EnableTouch> ON | OFF
 *RST: OFF

DISPlay:LCD <EnableLCD>

Turns the LCD display on or off.

Parameters:

<EnableLCD> ON | OFF
 *RST: OFF

15.15 WLAN Connection (Option R&S RTH-K200/200US)

SYSTem:COMMunicate:WLAN:MODE <Mode>

Selects the wireless LAN function of the instrument. It can serve as access point or as client.

Parameters:

<Mode> ACCesspoint | CLient
*RST: ACCesspoint

15.16 User Scripting (R&S RTH-K38)

UAPP:PATH <AppPath>

Sets the path and filename of the user app. Make sure to load the app to the instrument before ([MMEMory:COPY](#)).

Parameters:

<AppPath> String parameter

UAPP:PERSistence <AppPersistence>

If ON,

Set the app persistence ON if the app contains commands that would otherwise reset the app, for example, *RST, :OP, mode changes.

Parameters:

<AppPersistence> ON | OFF
*RST: OFF

Annex

A SCPI Command Structure

SCPI commands consist of a header and, in most cases, one or more parameters. The header and the parameters are separated by a "white space" (ASCII code 0 to 9, 11 to 32 decimal, e.g. blank). The headers may consist of several mnemonics (keywords). Queries are formed by appending a question mark directly to the header.

The commands can be either device-specific or device-independent (common commands). Common and device-specific commands differ in their syntax.

A.1 Syntax for Common Commands

Common (= device-independent) commands consist of a header preceded by an asterisk (*), and possibly one or more parameters.

Table A-1: Examples of common commands

*RST	RESET	Resets the instrument.
*ESE	EVENT STATUS ENABLE	Sets the bits of the event status enable registers.
*ESR?	EVENT STATUS QUERY	Queries the contents of the event status register.
*IDN?	IDENTIFICATION QUERY	Queries the instrument identification string.

A.2 Syntax for Device-Specific Commands



Not all commands used in the following examples are necessarily implemented in the instrument. For demonstration purposes only, assume the existence of the following commands for this section:

- DISPLAY[:WINDow<1...4>]:MAXimize <Boolean>
- FORMat:READings:DATA <type>[,<length>]
- HCOpy:DEvice:COLor <Boolean>
- HCOpy:DEvice:CMAP:COLor:RGB <red>,<green>,<blue>
- HCOpy[:IMMediate]
- HCOpy:ITEM:ALL
- HCOpy:ITEM:LABel <string>
- HCOpy:PAGE:DIMensions:QUADrant[<N>]
- HCOpy:PAGE:ORientation LANDscape | PORTrait
- HCOpy:PAGE:SCALE <numeric value>
- MMEMory:COpy <file_source>,<file_destination>
- SENSE:BANDwidth|BWIDth[:RESolution] <numeric_value>
- SENSE:FREQuency:STOP <numeric value>
- SENSE:LIST:FREQuency <numeric_value>{,<numeric_value>}

- [Long and short form](#)..... 511
- [Numeric Suffixes](#)..... 512
- [Optional Mnemonics](#)..... 512

A.2.1 Long and short form

The mnemonics feature a long form and a short form. The short form is marked by upper case letters, the long form corresponds to the complete word. Either the short form or the long form can be entered; other abbreviations are not permitted.

Example:

HCOpy:DEvice:COLor ON is equivalent to HCOpy:DEV:COL ON.



Case-insensitivity

Upper case and lower case notation only serves to distinguish the two forms in the manual, the instrument itself is case-insensitive.

A.2.2 Numeric Suffixes

If a command can be applied to multiple instances of an object, e.g. specific channels or sources, the required instances can be specified by a suffix added to the command. Numeric suffixes are indicated by angular brackets (<1...4>, <n>, <i>) and are replaced by a single value in the command. Entries without a suffix are interpreted as having the suffix 1.

Example:

Definition: `HCOPY:PAGE:DIMensions:QUADrant [<N>]`

Command: `HCOPY:PAGE:DIM:QUAD2`

This command refers to the quadrant 2.



Different numbering in remote control

For remote control, the suffix may differ from the number of the corresponding selection used in manual operation. SCPI prescribes that suffix counting starts with 1. Suffix 1 is the default state and used when no specific suffix is specified.

Some standards define a fixed numbering, starting with 0. If the numbering differs in manual operation and remote control, it is indicated for the corresponding command.

A.2.3 Optional Mnemonics

Some command systems permit certain mnemonics to be inserted into the header or omitted. These mnemonics are marked by square brackets in the description. The instrument must recognize the long command to comply with the SCPI standard. Some commands are considerably shortened by these optional mnemonics.

Example:

Definition: `HCOPY[:IMMEDIATE]`

Command: `HCOPY:IMM` is equivalent to `HCOPY`



Optional mnemonics with numeric suffixes

Do not omit an optional mnemonic if it includes a numeric suffix that is relevant for the effect of the command.

Example:

Definition: `DISPlay[:WINDow<1...4>]:MAXimize <Boolean>`

Command: `DISP:MAX ON` refers to window 1.

In order to refer to a window other than 1, you must include the optional `WINDow` parameter with the suffix for the required window.

`DISP:WIND2:MAX ON` refers to window 2.

A.3 SCPI Parameters

Many commands are supplemented by a parameter or a list of parameters. The parameters must be separated from the header by a "white space" (ASCII code 0 to 9, 11 to 32 decimal, e.g. blank).

The parameters required for each command and the allowed range of values are specified in the command description.

Allowed parameters are:

• Numeric Values	513
• Special Numeric Values	514
• Boolean Parameters	514
• Text Parameters	515
• Character Strings	515
• Block Data	515

A.3.1 Numeric Values

Numeric values can be entered in any form, i.e. with sign, decimal point and exponent. Values exceeding the resolution of the instrument are rounded up or down. The mantissa may comprise up to 255 characters, the exponent must lie inside the value range -32000 to 32000. The exponent is introduced by an "E" or "e". Entry of the exponent alone is not allowed.

Example:

```
SENS:FREQ:STOP 1500000 = SENS:FREQ:STOP 1.5E6
```

Units

For physical quantities, the unit can be entered. If the unit is missing, the basic unit is used. Allowed unit prefixes are:

- G (giga)
- MA (mega), MOHM, MHZ
- K (kilo)
- M (milli)
- U (micro)
- N (nano)

Example:

```
SENSe:FREQ:STOP 1.5GHz = SENSe:FREQ:STOP 1.5E9
```

Some settings allow relative values to be stated in percent. According to SCPI, this unit is represented by the PCT string.

Example:

```
HCOP:PAGE:SCAL 90PCT
```

A.3.2 Special Numeric Values

The following mnemonics are special numeric values. In the response to a query, the numeric value is provided.

- **MIN and MAX:** denote the minimum and maximum value.
- **DEF:** denotes a preset value which has been stored in the EPROM. This value conforms to the default setting, as it is called by the *RST command.
- **UP and DOWN:** increases or reduces the numeric value by one step. The step width can be specified via an allocated step command for each parameter which can be set via UP and DOWN.
- **INF and NINF:** INFinity and negative INFinity (NINF) represent the numeric values 9.9E37 or -9.9E37, respectively. INF and NINF are only sent as instrument responses.
- **NAN:** Not A Number (NAN) represents the value 9.91E37. NAN is only sent as a instrument response. This value is not defined. Possible causes are the division of zero by zero, the subtraction of infinite from infinite and the representation of missing values.

Example:

```
Setting command: SENSE:LIST:FREQ MAXimum
```

```
Query: SENS:LIST:FREQ?
```

```
Response: 3.5E9
```

**Queries for special numeric values**

The numeric values associated to MAXimum/MINimum/DEFault can be queried by adding the corresponding mnemonic after the quotation mark.

```
Example: SENSE:LIST:FREQ? MAXimum
```

Returns the maximum numeric value as a result.

A.3.3 Boolean Parameters

Boolean parameters represent two states. The "ON" state (logically true) is represented by "ON" or a numeric value 1. The "OFF" state (logically untrue) is represented by "OFF" or the numeric value 0. The numeric values are provided as the response for a query.

Example:

Setting command: `HCOPY:DEV:COL ON`

Query: `HCOPY:DEV:COL?`

Response: 1

A.3.4 Text Parameters

Text parameters observe the syntactic rules for mnemonics, i.e. they can be entered using a short or long form. Like any parameter, they have to be separated from the header by a white space. In the response to a query, the short form of the text is provided.

Example:

Setting command: `HCOPY:PAGE:ORIENTATION LANDscape`

Query: `HCOPY:PAGE:ORI?`

Response: LAND

A.3.5 Character Strings

Strings must always be entered in quotation marks (' or ").

Example:

`HCOPY:ITEM:LABEL "Test1"`

`HCOPY:ITEM:LABEL 'Test1'`

A.3.6 Block Data

Block data is a format which is suitable for the transmission of large amounts of data. For example, a command using a block data parameter has the following structure:

```
FORMat:READings:DATA #45168xxxxxxxx
```

The ASCII character # introduces the data block. The next number indicates how many of the following digits describe the length of the data block. In the example the 4 following digits indicate the length to be 5168 bytes. The data bytes follow. During the transmission of these data bytes all end or other control signs are ignored until all bytes are transmitted.

#0 specifies a data block of indefinite length. The use of the indefinite format requires a `NL^END` message to terminate the data block. This format is useful when the length of the transmission is not known or if speed or other considerations prevent segmentation of the data into blocks of definite length.

A.4 Overview of Syntax Elements

The following tables provide an overview of the syntax elements and special characters.

Table A-2: Syntax elements

:	The colon separates the mnemonics of a command.
;	The semicolon separates two commands of a command line. It does not alter the path.
,	The comma separates several parameters of a command.
?	The question mark forms a query.
*	The asterisk marks a common command.
' '	Quotation marks introduce a string and terminate it (both single and double quotation marks are possible).
#	The hash symbol introduces binary, octal, hexadecimal and block data. <ul style="list-style-type: none"> • Binary: #B10110 • Octal: #O7612 • Hexa: #HF3A7 • Block: #21312
	A "white space" (ASCII-Code 0 to 9, 11 to 32 decimal, e.g. blank) separates the header from the parameters.

Table A-3: Special characters

	<p>Parameters</p> <p>A vertical stroke in parameter definitions indicates alternative possibilities in the sense of "or". The effect of the command differs, depending on which parameter is used.</p> <p>Example:</p> <p>Definition:HCOPY:PAGE:ORIENTATION LANDscape PORTRait</p> <p>Command HCOP:PAGE:ORI LAND specifies landscape orientation</p> <p>Command HCOP:PAGE:ORI PORT specifies portrait orientation</p> <p>Mnemonics</p> <p>A selection of mnemonics with an identical effect exists for several commands. These mnemonics are indicated in the same line; they are separated by a vertical stroke. Only one of these mnemonics needs to be included in the header of the command. The effect of the command is independent of which of the mnemonics is used.</p> <p>Example:</p> <p>DefinitionSENSE:BANDwidth BWIDth[:RESolution] <numeric_value></p> <p>The two following commands with identical meaning can be created:</p> <p>SENS:BAND:RES 1</p> <p>SENS:BWID:RES 1</p>
[]	<p>Mnemonics in square brackets are optional and may be inserted into the header or omitted.</p> <p>Example: HCOpy[:IMMediate]</p> <p>HCOP: IMM is equivalent to HCOP</p>
{ }	<p>Parameters in curly brackets are optional and can be inserted once or several times, or omitted.</p> <p>Example: SENSE:LIST:FREQuency <numeric_value>{,<numeric_value>}</p> <p>The following are valid commands:</p> <p>SENS:LIST:FREQ 10</p> <p>SENS:LIST:FREQ 10,20</p> <p>SENS:LIST:FREQ 10,20,30,40</p>

A.5 Structure of a Command Line

A command line may consist of one or several commands. It is terminated by one of the following:

- <New Line>
- <New Line> with EOI
- EOI together with the last data byte

Several commands in a command line must be separated by a semicolon ";".

Example:

```
MMEM:COPY "Test1","MeasurementXY";:HCOP:ITEM ALL
```

This command line contains two commands. The first command belongs to the MMEM system, the second command belongs to the HCOP system. If the next command belongs to a different command system, the semicolon is followed by a colon.

Example:

```
HCOP:ITEM ALL;:HCOP:IMM
```

This command line contains two commands. Both commands are part of the `HCOP` command system, i.e. they have one level in common.

If the successive commands belong to the same system, having one or several levels in common, the command line can be abbreviated. When abbreviating the command line, the second command begins with the level below `HCOP`. The colon after the semi-colon is omitted. The abbreviated form of the command line reads as follows:

```
HCOP:ITEM ALL;IMM
```

Example:

```
HCOP:ITEM ALL
```

```
HCOP:IMM
```

A new command line always begins with the complete path.

A.6 Responses to Queries

A query is defined for each setting command unless explicitly specified otherwise. It is formed by adding a question mark to the associated setting command. According to SCPI, the responses to queries are partly subject to stricter rules than in standard IEEE 488.2.

- The requested parameter is transmitted without a header.
Example: `HCOP:PAGE:ORI?`, **Response:** `LAND`
- Maximum values, minimum values and all other quantities that are requested via a special text parameter are returned as numeric values.
Example: `SENSe:FREQuency:STOP? MAX`, **Response:** `3.5E9`
- Numeric values are output without a unit. Physical quantities are referred to the basic units or to the units set using the `Unit` command. The response `3.5E9` in the previous example stands for 3.5 GHz.
- Truth values (Boolean values) are returned as 0 (for OFF) and 1 (for ON).
Example:
Setting command: `HCOPY:DEV:COL ON`
Query: `HCOPY:DEV:COL?`
Response: `1`
- Text (character data) is returned in a short form.
Example:
Setting command: `HCOPY:PAGE:ORIENTATION LANDscape`
Query: `HCOP:PAGE:ORI?`
Response: `LAND`
- Invalid numerical results
In some cases, particularly when a result consists of multiple numeric values, invalid values are returned as `9.91E37` (not a number).

B Command Sequence and Synchronization

IEEE 488.2 defines a distinction between overlapped (asynchronous) and sequential commands:

- A sequential command finishes executing before the next command starts executing. Commands that are processed quickly are usually implemented as sequential commands.
- An overlapping or asynchronous command does not automatically finish executing before the next command starts executing. Usually, overlapping commands take longer to process and allow the program to do other tasks while being executed. If overlapping commands must be executed in a defined order, e.g. to avoid wrong measurement results, they must be serviced sequentially. This method is called synchronization between the controller and the instrument.



As a rule, send commands and queries in different program messages, i.e. in separate command lines.

Do not combine queries with commands that affect the queried value in one program message because the response to the query is not predictable.

The following messages always return correct results:

```
:CHAN:SCAL 0.01;POS 1
```

```
:CHAN:SCAL?
```

Result: 0.01 (10 mV/div)

Reason: Setting commands within one command line, even though they are implemented as sequential commands, are not necessarily serviced in the order in which they have been received.

For further information, refer to:

- rohde-schwarz.com/rckb: Rohde & Schwarz web page that provides information on instrument drivers and remote control.
- "Automatic Measurement Control - A tutorial on SCPI and IEEE 488.2" from John M. Pieper (R&S order number 0002.3536.00). The book offers detailed information on concepts and definitions of SCPI.

B.1 Preventing Overlapping Execution

To prevent an overlapping execution of commands, one of the commands `*OPC`, `*OPC?` or `*WAI` can be used. All three commands cause a certain action only to be carried out after the hardware has been set. The controller can be forced to wait for the corresponding action to occur.

Table B-1: Synchronization using *OPC, *OPC? and *WAI

Com- mand	Action	Programming the controller
*OPC	Sets the Operation Complete bit in the ESR after all previous commands have been executed.	<ul style="list-style-type: none"> Setting bit 0 in the ESE Setting bit 5 in the SRE Waiting for service request (SRQ)
*OPC?	Stops command processing until 1 is returned. This occurs when all pending operations are completed.	Send *OPC? directly after the command whose processing must be terminated before other commands can be executed.
*WAI	Stops further command processing until all commands sent before *WAI have been executed.	Send *WAI directly after the command whose processing must be terminated before other commands are executed.

Command synchronization using *WAI or *OPC? is a good choice if the overlapped command takes only little time to process. The two synchronization commands simply block overlapped execution of the command. Append the synchronization command to the overlapping command, for example:

```
SINGLE; *OPC?
```

For time consuming overlapped commands, you can allow the controller or the instrument to do other useful work while waiting for command execution. Use one of the following methods:

***OPC with a service request**

1. Set the OPC mask bit (bit no. 0) in the ESE: *ESE 1
2. Set bit no. 5 in the SRE: *SRE 32 to enable ESB service request.
3. Send the overlapped command with *OPC .
4. Wait for a service request.

The service request indicates that the overlapped command has finished.

***OPC? with a service request**

1. Set bit no. 4 in the SRE: *SRE 16 to enable MAV service request.
2. Send the overlapped command with *OPC?.
3. Wait for a service request.

The service request indicates that the overlapped command has finished.

Event status register (ESE)

1. Set the OPC mask bit (bit no. 0) in the ESE: *ESE 1
2. Send the overlapped command without *OPC, *OPC? or *WAI.
3. Poll the operation complete state periodically (with a timer) using the sequence: *OPC; *ESR?

A return value (LSB) of 1 indicates that the overlapped command has finished.

C User Scripting (R&S RTH-K38)

Using the scripting option R&S RTH-K38, you can run your own apps to automatize measurements or visualize specific results that are not available in the product. The option provides the interface to start the apps and an app window to show results. Apps are not included in the option.

C.1 Loading User Apps to the Instrument

Before you can run your app, you copy the file to the internal SD card to the `media/SD/Rohde-Schwarz/RTH/apps` folder.

To copy the app file, you can use:

- The tool "Browse Filesystem" on the instrument:
[FILE] > "Filesystem Tools" > "Browse Filesystem"
Select the file on the USB flash drive and copy it to the local `apps` folder.
- The upload function in the "File Browser".

C.2 Running User Apps

If the app file is available on the internal SD card, you can start the app.

To start an app

1. Press the [MODE] key.
2. Select "User".



3. Select the app in the `media/SD/Rohde-Schwarz/RTH/apps` folder.
If no app file has been copied before, the folder is empty.

The app is running, and the results are shown in the app window.

The corresponding remote command is `UAPP:PATH`.

To stop a running app

- ▶ Tap the "Close" icon in the upper right corner of the app window, or press the [BACK] key.
[PRESET] also stops the app.

When an app is running

The instrument works as follows when an app is running:

- The app window covers a part of the measurement display. To move the window, tap left beside the "Close" icon and drag it.
- The keys and the touchscreen work as usual, they are not blocked. Do not change settings that affect the measurements and results of the running app.
- Normal remote control and user apps cannot run at the same time.
- If you shut down the instrument while an app is running, the app starts automatically when you start the instrument again.

C.3 About User Apps

If you create your own apps, consider the following basic rules and notes:

- Each app is an html page, the file extension must be `.html`.
- The scripting language is JavaScript. The jquery.js library is available on the instrument.
- A simple stylesheet `/css/appstyle.css` can be used.
- To set the initial size and position of the app window, include a meta tag in the `<head>` element of the file, for example, `<meta name="RS_PagePos" content="400,40,390,400"> <!-- xleft,ytop,width,height -->`

Using SCPI commands

To control instrument functions, use remote commands with the `scpi.js` library. The relevant commands are `init()`, `query()`, `post()`, `get()`.

Use `scpi.init()` for commands that would otherwise reset the app, for example, `*RST`, `:OP`. The corresponding remote command is `UAPP:PERSistence`.

The following simple examples demonstrate the usage of SCPI commands:

```
var scpi = new SCPI();
scpi.init( initCmd, callback ); // the initCmd (string) may contain "*RST"
scpi.query( cmd, callback );   // cmd (string) may contain one or more queries e.g. "*IDN?"
scpi.post( data, callback );
scpi.get( callback );
```

Commands can be concatenated, separated by semicolons, for example:

```
"*RST;:CURS:FUNC TRAC;:CURS:STAT ON;"
```

The `init` and `query` callback has the type `Function(String response)`, with parameter `response` containing the query results and error status separated by semi-

colon. For example: A query like might return
 1;TRAC;0.050196078431;-0.050196078431;0,"No error".

For synchronization, use the callback. Prepare the next command or query when the previous command has returned.

Debugging the app

1. Copy the app file to the instrument.
2. Connect the instrument to the LAN.
3. On the computer, open the browser.
4. Enter the address: `http://<RTH-Url>/apps/<appname>.html`. Do *not* start the app on the instrument.

The app is now running in the browser window on the computer. The display can differ because of different fonts and window size.

5. Start the integrated debugger of the browser, usually with [F12].

For additional support, please contact the Rohde & Schwarz customer support.

C.4 Demo App

The following code is a example app, which shows the file structure and usage of remote commands. You can copy the code to an html file, copy the file to the internal SD card, and run the app. You can also contact the Rohde & Schwarz customer support to get the file.

```
<!doctype html>
<html>
<!-- User App Demo page for Rohde & Schwarz RTH -->
<head>
<link rel="stylesheet" type="text/css" href="/css/appstyle.css">
<meta charset="utf-8">
<meta name="RS_PagePos" content="400,40,390,400"> <!-- xleft,ytop,width,height -->
<title>Demo</title>
<script src="/jquery.js"></script>

<script src="/scpi.js"></script>

</head>

<body>
<h1 id="MyHeader">Web-App Demo</h1>
Cursor state: <span id=CursorState>0</span><br>
<span id=CursorType>Type: VERT</span><br>
<span id=CursorX1>x1: 0</span><br>
```

```
<span id=CursorX2>x2: 0</span><br>
<span id=CursorY1>y1: 0</span><br>
<span id=CursorY2>y2: 0</span><br>
<input type="checkbox" id="CursorStateButton">
<span id="CursorCBState">Cursor state</span><br>
<canvas id="MyCanvas" width="300" height="150" style="border:1px solid #d3d3d3;">
Your browser does not support the HTML5 canvas tag.</canvas>
<script>
var scpi = new SCPI();

var bInit = true;
var a1 = new Array();
var a2 = new Array();

var g_aMax=0;
var g_aMin=0;

function calcRange( a ) {
    var i;
    for( i=0; i<a.length; ++i )
    {
        var y = a[i];
        if ( bInit && !isNaN(y) ) {
            g_aMax = y;
            g_aMin = y;
            bInit = false;
        }

        if ( y>g_aMax && !isNaN(y) )
            g_aMax = y;

        if ( y<g_aMin && !isNaN(y) )
            g_aMin = y;
    }
}

function drawPath( a, ctx, width, height ) {

    var aMax = g_aMax;
    var aMin = g_aMin;
    if ( aMax==aMin )
        aMax = aMin + 1;

    var i;

    ctx.beginPath();
    for( i=0; i<a.length; ++i )
    {
        var y = height * (1 - (a[i]-aMin) / (aMax - aMin) );
        if ( i==0 )
```



```

        ctx.moveTo(0,y);
    else
        ctx.lineTo(i*3,y);
    }
    ctx.stroke();
}

function updateCanvas(y1,y2) {
    var c=document.getElementById("MyCanvas");
    var ctx=c.getContext("2d");

    ctx.fillStyle="#000040";
    ctx.fillRect(0,0,c.width,c.height);

    if ( ! isNaN(y1) && ! isNaN(y2) )
    {
        a1.push(y1);
        a2.push(y2);

        while( a1.length > 100 )
        {
            a1.shift();
            a2.shift();
        }

        calcRange(a1);
        calcRange(a2);

        ctx.strokeStyle="#FF8000";
        drawPath( a1, ctx, c.width, c.height );
        ctx.strokeStyle="#00FF00";
        drawPath( a2, ctx, c.width, c.height );
    }
}

function doUpdate() {
    scpi.query( ":RUN;:CURS:STAT?:FUNC?:X1P?:X2P?:Y1P?:Y2P?:Y1AM?:Y2AM?", function(r) {
        var results = r.split(";");
        var s = results[0];
        var f = results[1];
        $("#CursorState").text( s=="0" ? "off" : "on" );
        $("#CursorType").text( "Type: " + f );
        $("#CursorType").css("display", s=="0" ? "none" : "" );
        var bTrac = f=="TRAC";
        var bShowX = f == "VERT" || bTrac;
        var bShowY = f == "HOR" || bTrac;
        $("#CursorX1").css("display", s=="1" && bShowX ? "" : "none" );
        $("#CursorX2").css("display", s=="1" && bShowX ? "" : "none" );
        $("#CursorY1").css("display", s=="1" && bShowY ? "" : "none" );
        $("#CursorY2").css("display", s=="1" && bShowY ? "" : "none" );
    });
}

```

```

    $("#CursorX1").text( "x1: " + results[2] );
    $("#CursorX2").text( "x2: " + results[3] );
    var y1 = (bTrac ? results[6] : results[4]);
    var y2 = (bTrac ? results[7] : results[5]);
    $("#CursorY1").text( "y1: " + y1 );
    $("#CursorY2").text( "y2: " + y2 );

    // Set checkbox state
    $("#CursorStateButton").prop("checked",s == "1" );
    updateCanvas (parseFloat(+y1),parseFloat(+y2));
    setTimeout( "doUpdate()", 0); // Prepare for next update
  } );
}

$(document).ready(function() {

  var initCmd =
    "*RST;" +
    ":CURS:FUNC TRAC;" +
    ":CURS:STAT ON;" +
    ":TRIG:MODE SING;"
    ;

  scpi.init( initCmd, doUpdate ); // when initCmd is complete start updates

  $("#CursorStateButton").click(function(){
    var state = $("#CursorStateButton").prop("checked");
    var param = state ? "1" : "0";
    var serialData = "CURS:STAT " + param;
    scpi.post( serialData, function(){} );
    bInit = true;
  });
});

</script>
</body>
</html>

```

List of Commands

ACQUIRE:ARESet:IMMediate.....	312
ACQUIRE:AVAILable?.....	350
ACQUIRE:AVERAge:COUNT.....	312
ACQUIRE:MODE.....	312
ACQUIRE:POINts:ARATE?.....	313
ACQUIRE:POINts:PRESelect.....	312
ACQUIRE:POINts[:VALue]?.....	313
ACQUIRE:RESolution?.....	314
ACQUIRE:WAVEformupd.....	313
AUToscale.....	304
BUS:CAN:BITRate.....	456
BUS:CAN:DATA:SOURce.....	455
BUS:CAN:DATA:THReshold.....	457
BUS:CAN:FCOunt?.....	464
BUS:CAN:FDATa:ABITRate.....	457
BUS:CAN:FDATa:ASAMplepoint.....	457
BUS:CAN:FDATa:DBITRate.....	458
BUS:CAN:FDATa:DSAMplepoint.....	458
BUS:CAN:FDATa:ENABle.....	458
BUS:CAN:FDATa:FRAMe<m>:STANdard?.....	468
BUS:CAN:FDATa:PSStandar.....	458
BUS:CAN:FRAMe<m>:ACKState?.....	466
BUS:CAN:FRAMe<m>:ACKValue?.....	464
BUS:CAN:FRAMe<m>:BSEPosition?.....	464
BUS:CAN:FRAMe<m>:BYTE<n>:STATe?.....	465
BUS:CAN:FRAMe<m>:BYTE<n>:VALue?.....	465
BUS:CAN:FRAMe<m>:CSSTate?.....	466
BUS:CAN:FRAMe<m>:CSValue?.....	465
BUS:CAN:FRAMe<m>:DATA?.....	466
BUS:CAN:FRAMe<m>:DLCState?.....	466
BUS:CAN:FRAMe<m>:DLCValue?.....	466
BUS:CAN:FRAMe<m>:IDSTate?.....	466
BUS:CAN:FRAMe<m>:IDTpe?.....	467
BUS:CAN:FRAMe<m>:IDVValue?.....	467
BUS:CAN:FRAMe<m>:NDBYtes?.....	467
BUS:CAN:FRAMe<m>:SDATa?.....	468
BUS:CAN:FRAMe<m>:START?.....	468
BUS:CAN:FRAMe<m>:STATus?.....	468
BUS:CAN:FRAMe<m>:STOP?.....	468
BUS:CAN:FRAMe<m>:SYMBol?.....	469
BUS:CAN:FRAMe<m>:TYPE?.....	469
BUS:CAN:SAMPlEpoint.....	457
BUS:CAN:TECHnology.....	456
BUS:CAN:TYPE.....	456
BUS:FORMat.....	431
BUS:I2C:FCOunt?.....	436
BUS:I2C:FRAMe<m>:AACcEss?.....	436

BUS:I2C:FRAMe<m>:ACCess?	436
BUS:I2C:FRAMe<m>:ACOMplete?	436
BUS:I2C:FRAMe<m>:ADBStart?	437
BUS:I2C:FRAMe<m>:ADDRes?	437
BUS:I2C:FRAMe<m>:ADEVice?	437
BUS:I2C:FRAMe<m>:AMODE?	437
BUS:I2C:FRAMe<m>:ASTart?	438
BUS:I2C:FRAMe<m>:BCOut?	438
BUS:I2C:FRAMe<m>:BYTE<n>:ACCess?	438
BUS:I2C:FRAMe<m>:BYTE<n>:ACKStart?	438
BUS:I2C:FRAMe<m>:BYTE<n>:COMplete?	439
BUS:I2C:FRAMe<m>:BYTE<n>:STARt?	439
BUS:I2C:FRAMe<m>:BYTE<n>:VALue?	439
BUS:I2C:FRAMe<m>:DATA?	440
BUS:I2C:FRAMe<m>:RWBStart?	440
BUS:I2C:FRAMe<m>:STARt?	440
BUS:I2C:FRAMe<m>:STATus?	440
BUS:I2C:FRAMe<m>:STOP?	441
BUS:I2C:SCL:SOURce	432
BUS:I2C:SCL:THReshold	432
BUS:I2C:SDA:SOURce	432
BUS:I2C:SDA:THReshold	432
BUS:I2C:TECHnology	432
BUS:LIN:BITRate	471
BUS:LIN:DATA:SOURce	470
BUS:LIN:DATA:THReshold	471
BUS:LIN:FCOut?	475
BUS:LIN:FRAMe<m>:BYTE<n>:STATe?	475
BUS:LIN:FRAMe<m>:BYTE<n>:VALue?	475
BUS:LIN:FRAMe<m>:CSState?	476
BUS:LIN:FRAMe<m>:CSValue?	476
BUS:LIN:FRAMe<m>:DATA?	476
BUS:LIN:FRAMe<m>:IDPValue?	477
BUS:LIN:FRAMe<m>:IDState?	477
BUS:LIN:FRAMe<m>:IDValue?	477
BUS:LIN:FRAMe<m>:STARt?	478
BUS:LIN:FRAMe<m>:STATus?	478
BUS:LIN:FRAMe<m>:STOP?	478
BUS:LIN:FRAMe<m>:SYMBol?	478
BUS:LIN:FRAMe<m>:SYSTate?	479
BUS:LIN:POLarity	471
BUS:LIN:STANdard	471
BUS:LIN:TECHnology	472
BUS:SENT:CLKPeriod	481
BUS:SENT:CLKTolerance	481
BUS:SENT:CRCMethod	481
BUS:SENT:CRCVersion	481
BUS:SENT:DATA:SOURce	480
BUS:SENT:DATA:THReshold	480
BUS:SENT:DNIBbles	481

BUS:SENT:FCOunt?	486
BUS:SENT:FRAMe<m>:CSValue?	486
BUS:SENT:FRAMe<m>:DATA?	486
BUS:SENT:FRAMe<m>:DStatus?	487
BUS:SENT:FRAMe<m>:IDType?	487
BUS:SENT:FRAMe<m>:IDValue?	487
BUS:SENT:FRAMe<m>:NIBBle<n>:STATe?	488
BUS:SENT:FRAMe<m>:NIBBle<n>:VALue?	488
BUS:SENT:FRAMe<m>:PAPTicks?	488
BUS:SENT:FRAMe<m>:SCOM?	488
BUS:SENT:FRAMe<m>:SDATa?	489
BUS:SENT:FRAMe<m>:STARt?	489
BUS:SENT:FRAMe<m>:STATus?	489
BUS:SENT:FRAMe<m>:STOP?	490
BUS:SENT:FRAMe<m>:SYMBol?	490
BUS:SENT:FRAMe<m>:SYNCduration?	490
BUS:SENT:FRAMe<m>:TYPE?	491
BUS:SENT:POLarity	480
BUS:SENT:PPFLength	482
BUS:SENT:PPULse	482
BUS:SENT:RDSL	482
BUS:SENT:SFORMat	482
BUS:SENT:TECHnology	480
BUS:SETReflevels	432
BUS:SETReflevels	443
BUS:SETReflevels	450
BUS:SETReflevels	457
BUS:SETReflevels	472
BUS:SPI:FCOunt?	446
BUS:SPI:FRAMe<m>:DATA?	446
BUS:SPI:FRAMe<m>:STARt?	446
BUS:SPI:FRAMe<m>:STATus?	446
BUS:SPI:FRAMe<m>:STOP?	447
BUS:SPI:FRAMe<m>:WCOunt?	447
BUS:SPI:FRAMe<m>:WORD<n>:MISO?	447
BUS:SPI:FRAMe<m>:WORD<n>:MOSI?	448
BUS:SPI:FRAMe<m>:WORD<n>:STARt?	448
BUS:SPI:FRAMe<m>:WORD<n>:STOP?	448
BUS:SPI:MISO:SOURce	442
BUS:SPI:MISO:THReshold	443
BUS:SPI:MOSI:SOURce	442
BUS:SPI:MOSI:THReshold	443
BUS:SPI:ORDer	443
BUS:SPI:SCLK:SLOPe	442
BUS:SPI:SCLK:SOURce	442
BUS:SPI:SCLK:THReshold	443
BUS:SPI:SSEL:POLarity	442
BUS:SPI:SSEL:SOURce	442
BUS:SPI:SSEL:STATe	444
BUS:SPI:SSEL:THReshold	443

BUS:SPI:TECHnology.....	442
BUS:SPI:TIMeout.....	444
BUS:SPI:WSIZe.....	443
BUS:TYPE.....	431
BUS:UART:BITRate.....	451
BUS:UART:FRAMemode.....	452
BUS:UART:ORDer.....	451
BUS:UART:PARity.....	451
BUS:UART:POLarity.....	449
BUS:UART:SBIT.....	451
BUS:UART:SOURce.....	449
BUS:UART:SSIZe.....	451
BUS:UART:STDBitrate.....	450
BUS:UART:TECHnology.....	450
BUS:UART:THReshold.....	450
BUS:UART:TOUT.....	452
BUS:UART:WCOunt?.....	453
BUS:UART:WORD<m>:START?.....	454
BUS:UART:WORD<m>:STATe?.....	453
BUS:UART:WORD<m>:STOP?.....	454
BUS:UART:WORD<m>:VALue?.....	455
BUS[:STATe].....	431
CALCulate:MATH:STATe.....	347
CALCulate:MATH:VERTical:POSition.....	348
CALCulate:MATH:VERTical:RANGe.....	348
CALCulate:MATH:VERTical:SCALE.....	348
CALCulate:MATH[:EXPReSSion][:DEFine].....	347
CHANnel<m>:BANDwidth.....	308
CHANnel<m>:COUPling.....	307
CHANnel<m>:DATA:HEADer?.....	499
CHANnel<m>:DATA[:VALues]?.....	499
CHANnel<m>:DESKew.....	308
CHANnel<m>:HISTory:CURRent.....	351
CHANnel<m>:HISTory:NSEGments.....	350
CHANnel<m>:HISTory:PLAY.....	352
CHANnel<m>:HISTory:REPLay.....	352
CHANnel<m>:HISTory:START.....	351
CHANnel<m>:HISTory:STOP.....	351
CHANnel<m>:HISTory:TPACq.....	350
CHANnel<m>:HISTory:TSABbsolute?.....	352
CHANnel<m>:HISTory:TSDate?.....	352
CHANnel<m>:HISTory:TSRelative?.....	353
CHANnel<m>:HISTory[:STATe].....	350
CHANnel<m>:OFFSet.....	307
CHANnel<m>:POLarity.....	308
CHANnel<m>:POSition.....	307
CHANnel<m>:PROBe.....	305
CHANnel<m>:RANGe.....	305
CHANnel<m>:SCALE.....	305
CHANnel<m>:STATe.....	304

CHANnel<m>:THReshold:FINDlevel.....	310
CHANnel<m>:THReshold:TECHnology.....	309
CHANnel<m>:THReshold:THReshold?.....	309
CHANnel<m>:THReshold:USER.....	309
COUNter<m>:ABORT.....	412
COUNter<m>:CALCulate:AVERage:ALL?.....	412
COUNter<m>:CALCulate:AVERage:AVERage?.....	412
COUNter<m>:CALCulate:AVERage:CLear.....	412
COUNter<m>:CALCulate:AVERage:COUNt:CURRent?.....	413
COUNter<m>:CALCulate:AVERage:MAXimum?.....	413
COUNter<m>:CALCulate:AVERage:MINimum?.....	413
COUNter<m>:CONFigure:FREQuency.....	414
COUNter<m>:CONFigure:VALue?.....	414
COUNter<m>:FETCh?.....	414
COUNter<m>:INITiate.....	415
COUNter<m>:MEASure:FREQuency?.....	415
COUNter<m>:READ?.....	416
COUNter<m>:SENSe:FUNcTion.....	416
COUNter<m>:SENSe:RANGe.....	416
COUNter<m>:SENSe:REFerence:STATe.....	416
COUNter<m>:SENSe:REFerence:VALue.....	417
COUNter<m>:SENSe:SOURce.....	417
COUNter<m>:SENSe:STATe.....	417
COUNter<m>:SENSe:TRIGger:MODE.....	417
CURSor:COUPling.....	344
CURSor:DELTA?.....	345
CURSor:FUNcTion.....	343
CURSor:ITDelta?.....	345
CURSor:MEASurement<m>:RESult:ACTual?.....	346
CURSor:MEASurement<m>:RESult:LIMit?.....	346
CURSor:MEASurement<m>:TYPE.....	344
CURSor:SCPLing.....	344
CURSor:SCReen.....	344
CURSor:SOURce.....	343
CURSor:STATe.....	343
CURSor:TDELTA?.....	345
CURSor:X1Position.....	345
CURSor:X2Position.....	345
CURSor:Y1Amplitude?.....	346
CURSor:Y1Position.....	346
CURSor:Y2Amplitude?.....	346
CURSor:Y2Position.....	346
DISPlay:CONTrast.....	508
DISPlay:LCD.....	508
DISPlay:MOUS.....	508
DISPlay:PERsistence:TIME.....	508
DISPlay:PERsistence[:TYPE].....	507
EXPort:WAVEform:DLOGging.....	496
EXPort:WAVEform:INCXvalues.....	496
EXPort:WAVEform:MULTichannel.....	496

EXPort:WAVEform:NAME.....	495
EXPort:WAVEform:SAVE.....	497
EXPort:WAVEform:SOURce.....	495
FORMat:BORDER.....	498
FORMat[:DATA].....	498
HARMonic:AVERAge.....	372
HARMonic:CLEar.....	372
HARMonic:DISPlay:TYPE.....	372
HARMonic:DISPlay:USER.....	373
HARMonic:EXPort:NAME.....	377
HARMonic:EXPort:SAVE.....	377
HARMonic:FUNDamental:CURRent?.....	374
HARMonic:FUNDamental:TYPE.....	373
HARMonic:FUNDamental:USER.....	374
HARMonic:LIMits:CURRent?.....	375
HARMonic:LIMits:LOAD.....	375
HARMonic:LIMits:NAME.....	374
HARMonic:LIMits:TYPE.....	375
HARMonic:RESult<m>:CLIPping?.....	377
HARMonic:RESult<m>:FRQMissing?.....	377
HARMonic:RESult<m>:FUNDamental?.....	378
HARMonic:RESult<m>:HARMonics<n>:ABSMagnitude:MAXimum?.....	378
HARMonic:RESult<m>:HARMonics<n>:ABSMagnitude:MINimum?.....	378
HARMonic:RESult<m>:HARMonics<n>:ABSMagnitude[:CURRent]?.....	378
HARMonic:RESult<m>:HARMonics<n>:LIMCheck?.....	378
HARMonic:RESult<m>:HARMonics<n>:LIMit?.....	379
HARMonic:RESult<m>:HARMonics<n>:LIMViolation?.....	380
HARMonic:RESult<m>:HARMonics<n>:PHASe?.....	380
HARMonic:RESult<m>:HARMonics<n>:RELMagnitude:MAXimum?.....	381
HARMonic:RESult<m>:HARMonics<n>:RELMagnitude:MINimum?.....	381
HARMonic:RESult<m>:HARMonics<n>:RELMagnitude[:CURRent]?.....	381
HARMonic:RESult<m>:HARMonics<n>[:FREQuency]?.....	381
HARMonic:RESult<m>:LIMViolation?.....	381
HARMonic:RESult<m>:NOHarmonics?.....	382
HARMonic:RESult<m>:NOResults?.....	382
HARMonic:RESult<m>:RMS:MAXimum?.....	382
HARMonic:RESult<m>:RMS:MINimum?.....	382
HARMonic:RESult<m>:RMS[:CURRent]?.....	382
HARMonic:RESult<m>:THD:MAXimum?.....	383
HARMonic:RESult<m>:THD:MINimum?.....	383
HARMonic:RESult<m>:THD[:CURRent]?.....	383
HARMonic:SCALe.....	375
HARMonic:STATistic.....	376
HARMonic:THDType.....	376
HCOPY:COLor.....	500
HCOPY:IMMediate.....	500
HCOPY:INVerse.....	500
HCOPY:LANGUage.....	500
LOGGer:ACLR.....	420
LOGGer:AUTOset.....	421

LOGGer:CURSor:COUPLing.....	424
LOGGer:CURSor:RESult<n>:DELTA?.....	424
LOGGer:CURSor:SCPLing.....	423
LOGGer:CURSor:SCReen.....	424
LOGGer:CURSor:TDELta?.....	425
LOGGer:CURSor:TYPE.....	423
LOGGer:CURSor[:STATe].....	423
LOGGer:CURSor<m>:POSition.....	425
LOGGer:CURSor<m>:RESult<n>[:AMPLitude]?.....	424
LOGGer:MEASurement<m>:ENABLED?.....	429
LOGGer:MEASurement<m>:RESult:CURRentsampl?.....	427
LOGGer:MEASurement<m>:RESult:MAXimum:POSition?.....	427
LOGGer:MEASurement<m>:RESult:MAXimum:VALue?.....	427
LOGGer:MEASurement<m>:RESult:MEAN?.....	428
LOGGer:MEASurement<m>:RESult:MINimum:POSition?.....	428
LOGGer:MEASurement<m>:RESult:MINimum:VALue?.....	428
LOGGer:MEASurement<m>:RESult:STDDev?.....	428
LOGGer:MEASurement<m>:SOURce?.....	429
LOGGer:MEASurement<m>:TYPE?.....	429
LOGGer:MEASurement<m>:VERTical:AUTO.....	421
LOGGer:MEASurement<m>:VERTical:DEVIation.....	422
LOGGer:MEASurement<m>:VERTical:LOWer.....	421
LOGGer:MEASurement<m>:VERTical:MEAN.....	422
LOGGer:MEASurement<m>:VERTical:UPPer.....	421
LOGGer:RECORDing:STARt?.....	426
LOGGer:RECORDing:TOTal?.....	427
LOGGer:SLOT:ACTive?.....	430
LOGGer:SLOT:CLear.....	420
LOGGer:SLOT:CURRent.....	419
LOGGer:SLOT:EXPort:NAME.....	430
LOGGer:SLOT:EXPort:SAVE.....	430
LOGGer:SLOT:LOAD.....	420
LOGGer:SLOT:SLOT<m>:HASData?.....	419
LOGGer:SLOT:SLOT<m>:NAME.....	419
LOGGer:SLOT:SLOT<m>:STARt?.....	420
LOGGer:SOURce.....	418
LOGGer:TIMEbase:SCALE.....	419
LOGGer:TIMEbase:SRATE.....	418
LOGGer:ZOOM:ENABLE.....	425
LOGGer:ZOOM:POSition.....	426
LOGGer:ZOOM:SCALE.....	426
LOGic:CHANnel<m>:DESKew.....	493
LOGic:GROup<m>:HYSteresis.....	493
LOGic:GROup<m>:TECHnology.....	492
LOGic:GROup<m>:THReshold?.....	493
LOGic:GROup<m>:USER.....	492
LOGic:STATE.....	491
LOGic:THCOupling.....	491
MASK:CHANnel<m>:CREatemask.....	354
MASK:CHANnel<m>:PROPerties:XWIDth.....	353

MASK:CHANnel<m>:PROPerties:YWIDTH.....	354
MASK:CHANnel<m>:RESult:FAIL:PERCentage?.....	355
MASK:CHANnel<m>:RESult:FAIL[:COUNT]?.....	355
MASK:CHANnel<m>:RESult:PASS:PERCentage?.....	356
MASK:CHANnel<m>:RESult:PASS[:COUNT]?.....	356
MASK:CHANnel<m>:RESult:TOTL[:COUNT]?.....	356
MASK:CHANnel<m>:STATe.....	353
MASK:ELAPsedtime:TOTal?.....	356
MASK:ELAPsedtime[:SECS]?.....	357
MASK:ONViolation[:SELECTION].....	354
MASK:RST.....	355
MASK[:TESTstate]?.....	355
MEASurement<m>:AOFF.....	342
MEASurement<m>:DELay:SLOPe.....	342
MEASurement<m>:ENABle.....	340
MEASurement<m>:RESult:ACTual?.....	342
MEASurement<m>:RESult:LIMit?.....	342
MEASurement<m>:SOURce.....	341
MEASurement<m>:TYPE.....	341
METer:CONFigure:CAPacitance.....	385
METer:CONFigure:CONTInuity.....	385
METer:CONFigure:CURRent:AC.....	386
METer:CONFigure:CURRent:DC.....	386
METer:CONFigure:DIODE.....	385
METer:CONFigure:FREQuency.....	386
METer:CONFigure:RESistance.....	386
METer:CONFigure:TEMPerature.....	385
METer:CONFigure:VALue?.....	394
METer:CONFigure:VOLTage:AC.....	386
METer:CONFigure:VOLTage:DC.....	386
METer:MEASure:CAPacitance?.....	397
METer:MEASure:CONTInuity?.....	396
METer:MEASure:CURRent:AC?.....	397
METer:MEASure:CURRent:DC?.....	397
METer:MEASure:DIODE?.....	396
METer:MEASure:FREQuency?.....	396
METer:MEASure:RESistance?.....	397
METer:MEASure:TEMPerature?.....	396
METer:MEASure:VOLTage:AC?.....	397
METer:MEASure:VOLTage:DC?.....	397
METer:SENSe:CAPacitance:NULL:STATe.....	391
METer:SENSe:CAPacitance:NULL:VALue.....	392
METer:SENSe:CAPacitance:RANGe:AUTO.....	389
METer:SENSe:CAPacitance:RANGe:UPPer.....	387
METer:SENSe:CURRent:AC:NULL:STATe.....	391
METer:SENSe:CURRent:AC:NULL:VALue.....	392
METer:SENSe:CURRent:AC:RANGe:AUTO.....	389
METer:SENSe:CURRent:AC:RANGe:UPPer.....	387
METer:SENSe:CURRent:DC:NULL:STATe.....	391
METer:SENSe:CURRent:DC:NULL:VALue.....	392

METer:SENSe:CURRent:DC:RANGe:AUTO.....	389
METer:SENSe:CURRent:DC:RANGe:UPPer.....	387
METer:SENSe:FREQUency:VOLTagE:RANGe:AUTO.....	389
METer:SENSe:FREQUency:VOLTagE:RANGe:UPPer.....	388
METer:SENSe:FUNcTion.....	394
METer:SENSe:RESistance:NULL:STATe.....	391
METer:SENSe:RESistance:NULL:VALue.....	393
METer:SENSe:RESistance:RANGe:AUTO.....	389
METer:SENSe:RESistance:RANGe:UPPer.....	388
METer:SENSe:TEMPerature:NULL:STATe.....	391
METer:SENSe:TEMPerature:NULL:VALue.....	393
METer:SENSe:TEMPerature:TRANsductor:RTD:TYPE.....	391
METer:SENSe:VOLTagE:AC:NULL:STATe.....	391
METer:SENSe:VOLTagE:AC:NULL:VALue.....	392
METer:SENSe:VOLTagE:AC:RANGe:AUTO.....	389
METer:SENSe:VOLTagE:AC:RANGe:UPPer.....	388
METer:SENSe:VOLTagE:DC:NULL:STATe.....	391
METer:SENSe:VOLTagE:DC:NULL:VALue.....	392
METer:SENSe:VOLTagE:DC:RANGe:AUTO.....	389
METer:SENSe:VOLTagE:DC:RANGe:UPPer.....	388
METer:UNIT:TEMPerature.....	390
METer<m>:ABORt.....	395
METer<m>:ABORt.....	407
METer<m>:CALCulate:AVERage:AVERage?.....	398
METer<m>:CALCulate:AVERage:AVERage?.....	410
METer<m>:CALCulate:AVERage:CLear.....	399
METer<m>:CALCulate:AVERage:CLear.....	411
METer<m>:CALCulate:AVERage:MAXimum?.....	399
METer<m>:CALCulate:AVERage:MAXimum?.....	411
METer<m>:CALCulate:AVERage:MINimum?.....	398
METer<m>:CALCulate:AVERage:MINimum?.....	410
METer<m>:CONFigure:CURRent:AC.....	401
METer<m>:CONFigure:CURRent:DC.....	401
METer<m>:CONFigure:VALue?.....	407
METer<m>:CONFigure:VOLTagE:AC.....	402
METer<m>:CONFigure:VOLTagE:DC.....	402
METer<m>:FETCh?.....	396
METer<m>:FETCh?.....	408
METer<m>:INITiate.....	395
METer<m>:INITiate.....	408
METer<m>:MEASure:CURRent:AC?.....	409
METer<m>:MEASure:CURRent:DC?.....	409
METer<m>:MEASure:VOLTagE:AC?.....	409
METer<m>:MEASure:VOLTagE:DC?.....	409
METer<m>:READ?.....	395
METer<m>:READ?.....	408
METer<m>:SENSe:CURRent:AC:COUPling.....	390
METer<m>:SENSe:CURRent:AC:COUPling.....	403
METer<m>:SENSe:CURRent:AC:NULL:STATe.....	405
METer<m>:SENSe:CURRent:AC:NULL:VALue.....	405

METer<m>:SENSe:CURRent:AC:RANGe:UPPer.....	402
METer<m>:SENSe:CURRent:DC:NULL:STATe.....	405
METer<m>:SENSe:CURRent:DC:NULL:VALue.....	405
METer<m>:SENSe:CURRent:DC:RANGe:UPPer.....	402
METer<m>:SENSe:FUNCTion.....	406
METer<m>:SENSe:NULL:STATe.....	392
METer<m>:SENSe:NULL:STATe.....	405
METer<m>:SENSe:NULL:VALU.....	393
METer<m>:SENSe:NULL:VALU.....	406
METer<m>:SENSe:RANGe.....	401
METer<m>:SENSe:RELative:STATe.....	392
METer<m>:SENSe:RELative:STATe.....	405
METer<m>:SENSe:SOURce.....	400
METer<m>:SENSe:STATe.....	400
METer<m>:SENSe:VOLTage:AC:COUPling.....	390
METer<m>:SENSe:VOLTage:AC:COUPling.....	403
METer<m>:SENSe:VOLTage:AC:NULL:STATe.....	405
METer<m>:SENSe:VOLTage:AC:NULL:VALue.....	405
METer<m>:SENSe:VOLTage:AC:RANGe:UPPer.....	403
METer<m>:SENSe:VOLTage:DC:NULL:STATe.....	405
METer<m>:SENSe:VOLTage:DC:NULL:VALue.....	405
METer<m>:SENSe:VOLTage:DC:RANGe:UPPer.....	403
METer<m>:TRIGGer:MODE.....	394
METer<m>:TRIGGer:MODE.....	407
MMEMory:CATalog:LENGth?.....	505
MMEMory:CATalog?.....	504
MMEMory:CDIRectory.....	502
MMEMory:COPI.....	505
MMEMory:DATA.....	502
MMEMory:DCATalog:LENGth?.....	504
MMEMory:DCATalog?.....	503
MMEMory:DELeTe.....	506
MMEMory:MDIRectory.....	502
MMEMory:MOVE.....	505
MMEMory:NAME.....	500
MMEMory:RCL.....	501
MMEMory:RDIRectory.....	503
MMEMory:SAV.....	501
OP[:MODE].....	303
OP[:MODE].....	383
POD:STATe?.....	494
PROBe<m>:SETup:ATTenuation:MANual.....	306
PROBe<m>:SETup:ATTenuation:UNIT.....	306
REFCurve:DELeTe.....	349
REFCurve:NAME.....	349
REFCurve:OPEN.....	349
REFCurve:POSition.....	349
REFCurve:SAVE.....	349
REFCurve:SOURce.....	348
REFCurve:STATe.....	349

REFCurve:UPDate.....	348
RUN.....	311
SPECTrum:CURSor<m>:COUPLing.....	365
SPECTrum:CURSor<m>:FREQuency:DELTA?	366
SPECTrum:CURSor<m>:FREQuency[:VALue].....	366
SPECTrum:CURSor<m>:LEVel:DELTA?	366
SPECTrum:CURSor<m>:LEVel[:VALue]?	366
SPECTrum:CURSor<m>:SCPLing.....	365
SPECTrum:CURSor<m>:SCReen.....	367
SPECTrum:CURSor<m>:SOURce.....	365
SPECTrum:CURSor<m>:STATe.....	364
SPECTrum:EXPort:INCXvalues.....	371
SPECTrum:EXPort:NAME.....	371
SPECTrum:EXPort:SAVE.....	371
SPECTrum:FREQuency:AVERAge:COUNT.....	361
SPECTrum:FREQuency:BANDwidth[:RESolution]:AUTO.....	362
SPECTrum:FREQuency:BANDwidth[:RESolution]:RATio.....	362
SPECTrum:FREQuency:BANDwidth[:RESolution][:VALue].....	358
SPECTrum:FREQuency:CENTer.....	358
SPECTrum:FREQuency:FULLspan.....	362
SPECTrum:FREQuency:HORIZontal:SCALE.....	358
SPECTrum:FREQuency:MAGNitude:REFerence[:VALue].....	362
SPECTrum:FREQuency:MAGNitude:SCALE.....	358
SPECTrum:FREQuency:POSition.....	363
SPECTrum:FREQuency:RESet.....	364
SPECTrum:FREQuency:SAMPle?.....	359
SPECTrum:FREQuency:SCALE.....	363
SPECTrum:FREQuency:SPAN:MODE.....	359
SPECTrum:FREQuency:SPAN[:VALue].....	359
SPECTrum:FREQuency:START.....	359
SPECTrum:FREQuency:STOP.....	360
SPECTrum:FREQuency:WINDow:FACTor?.....	360
SPECTrum:FREQuency:WINDow:TYPE.....	360
SPECTrum:MARKer:COUNT.....	367
SPECTrum:MARKer:RCOunt?.....	369
SPECTrum:MARKer:RESult<m>:FREQuency:DELTA?	369
SPECTrum:MARKer:RESult<m>:FREQuency[:VALue]?	369
SPECTrum:MARKer:RESult<m>:LEVel:DELTA?	370
SPECTrum:MARKer:RESult<m>:LEVel[:VALue]?	370
SPECTrum:MARKer:RMARker:FREQuency?.....	370
SPECTrum:MARKer:RMARker:VALue?.....	371
SPECTrum:MARKer:SETup:DISTance.....	368
SPECTrum:MARKer:SETup:EXCursion.....	368
SPECTrum:MARKer:SETup:MLEVel.....	368
SPECTrum:MARKer:SOURce.....	368
SPECTrum:MARKer[:STATe].....	367
SPECTrum:MODE?.....	361
SPECTrum:SOURce.....	357
SPECTrum:WAVEform:AVERAge[:ENABLE].....	363
SPECTrum:WAVEform:MAXimum[:ENABLE].....	364

SPECTrum:WAVEform:MINimum[:ENABLE].....	364
SPECTrum:WAVEform:SPECTrum[:ENABLE].....	364
STOP.....	311
SYSTem:COMMunicate:WLAN:MODE.....	508
SYSTem:DATE.....	506
SYSTem:TIME.....	507
TIMebase:HORIZontal:POSition.....	310
TIMebase:RANGe.....	310
TIMebase:REFerence.....	311
TIMebase:SCALe.....	310
TRIGger:CAN:ACKerror.....	459
TRIGger:CAN:BITSterror.....	459
TRIGger:CAN:CRCError.....	460
TRIGger:CAN:DATA.....	460
TRIGger:CAN:DCONDition.....	460
TRIGger:CAN:FDATA:BRS.....	462
TRIGger:CAN:FDATA:DPOSITION.....	463
TRIGger:CAN:FDATA:ESI.....	463
TRIGger:CAN:FDATA:FDf.....	463
TRIGger:CAN:FDATA:SCERror.....	463
TRIGger:CAN:FORMerror.....	460
TRIGger:CAN:FTYPE.....	460
TRIGger:CAN:ICONDition.....	461
TRIGger:CAN:IDENTifier.....	461
TRIGger:CAN:ITYPe.....	461
TRIGger:CAN:TYPE.....	462
TRIGger:DATatoclock:CONDition.....	332
TRIGger:DATatoclock:CSource:EDGE.....	332
TRIGger:DATatoclock:CSource[:VALue].....	332
TRIGger:DATatoclock:DSource[:VALue].....	332
TRIGger:DATatoclock:HTIME.....	333
TRIGger:DATatoclock:STIME.....	333
TRIGger:EDGE:SLOPe.....	317
TRIGger:EXTernal:LEVel.....	323
TRIGger:EXTernal:SLOPe.....	323
TRIGger:GLITch:POLarity.....	318
TRIGger:GLITch:RANGe.....	318
TRIGger:GLITch:WIDTh.....	318
TRIGger:HOLDoff:EVENTs.....	317
TRIGger:HOLDoff:MAX.....	317
TRIGger:HOLDoff:MIN.....	317
TRIGger:HOLDoff:MODE.....	316
TRIGger:HOLDoff:TIME.....	316
TRIGger:I2C:ACCess.....	434
TRIGger:I2C:ACONDition.....	434
TRIGger:I2C:ADDResS.....	434
TRIGger:I2C:ADNack.....	433
TRIGger:I2C:DATA.....	434
TRIGger:I2C:DCONDition.....	435
TRIGger:I2C:DPOSITION.....	435

TRIGger:I2C:DRNack.....	433
TRIGger:I2C:DWNack.....	433
TRIGger:I2C:MODE.....	433
TRIGger:INterval:DELTA.....	336
TRIGger:INterval:MAXWidth.....	337
TRIGger:INterval:MINWidth.....	336
TRIGger:INterval:RANGe.....	336
TRIGger:INterval:SLOPe.....	335
TRIGger:INterval:WIDTh.....	336
TRIGger:LEVel<m>:RUNT:LOWer.....	328
TRIGger:LEVel<m>:RUNT:UPPer.....	328
TRIGger:LEVel<m>:SLEW:LOWer.....	330
TRIGger:LEVel<m>:SLEW:UPPer.....	330
TRIGger:LEVel<m>:VALue.....	316
TRIGger:LEVel<m>:WINDow:LOWer.....	337
TRIGger:LEVel<m>:WINDow:UPPer.....	337
TRIGger:LIN:CHKSError.....	472
TRIGger:LIN:DATA.....	473
TRIGger:LIN:DCONDition.....	473
TRIGger:LIN:ICONDition.....	473
TRIGger:LIN:IDENtifier.....	473
TRIGger:LIN:IPERror.....	474
TRIGger:LIN:SYERror.....	474
TRIGger:LIN:TYPE.....	474
TRIGger:MNR.....	317
TRIGger:MODE.....	315
TRIGger:PATtern:STATe:COMBination.....	324
TRIGger:PATtern:STATe[:CHANnel<m>].....	324
TRIGger:PATtern:TIMEout[:TIME].....	325
TRIGger:PATtern:WIDTh:DELTA.....	326
TRIGger:PATtern:WIDTh:MAXWidth.....	326
TRIGger:PATtern:WIDTh:MINWidth.....	326
TRIGger:PATtern:WIDTh:RANGe.....	325
TRIGger:PATtern:WIDTh[:WIDTh].....	325
TRIGger:RUNT:DELTA.....	329
TRIGger:RUNT:MAXWidth.....	329
TRIGger:RUNT:MINWidth.....	329
TRIGger:RUNT:POLarity.....	328
TRIGger:RUNT:RANGe.....	328
TRIGger:RUNT:WIDTh.....	329
TRIGger:SENT:DATA.....	483
TRIGger:SENT:DCONDition.....	483
TRIGger:SENT:FCRCError.....	484
TRIGger:SENT:ICONDition.....	484
TRIGger:SENT:IDENtifier.....	484
TRIGger:SENT:IRFLength.....	485
TRIGger:SENT:PPERioderror.....	485
TRIGger:SENT:PULSeerror.....	485
TRIGger:SENT:SCONDition.....	484
TRIGger:SENT:SCRCError.....	485

TRIGger:SENT:STATus.....	484
TRIGger:SENT:TYPE.....	483
TRIGger:SLEW:DELTA.....	331
TRIGger:SLEW:MAXWidth.....	331
TRIGger:SLEW:MINWidth.....	331
TRIGger:SLEW:RANGe.....	330
TRIGger:SLEW:RATE.....	331
TRIGger:SLEW:SLOPe.....	330
TRIGger:SOURce.....	315
TRIGger:SPATtern:CSOURce:EDGE.....	334
TRIGger:SPATtern:CSOURce:FIRStedge.....	334
TRIGger:SPATtern:CSOURce[:VALue].....	334
TRIGger:SPATtern:DSOURce[:VALue].....	333
TRIGger:SPATtern:ORDer.....	334
TRIGger:SPATtern:PATtern.....	334
TRIGger:SPI:DATA.....	445
TRIGger:SPI:DCONdition.....	445
TRIGger:SPI:DPOStion.....	445
TRIGger:SPI:DSRC.....	444
TRIGger:SPI:MODE.....	444
TRIGger:STATe:CHANnel<m>.....	327
TRIGger:STATe:COMBination.....	327
TRIGger:STATe:CSOURce:EDGE.....	327
TRIGger:STATe:CSOURce[:VALue].....	327
TRIGger:TIMEout:RANGe.....	335
TRIGger:TIMEout:TIME.....	335
TRIGger:TV:CUSTom:LDURation.....	323
TRIGger:TV:CUSTom:SCANmode.....	323
TRIGger:TV:CUSTom:SDURation.....	323
TRIGger:TV:CUSTom:STYPe.....	322
TRIGger:TV:LFIeld.....	322
TRIGger:TV:LINE.....	322
TRIGger:TV:MODE.....	321
TRIGger:TV:POLarity.....	321
TRIGger:TV:STANdard.....	321
TRIGger:TYPE.....	315
TRIGger:UART:DATA.....	453
TRIGger:UART:DCONdition.....	453
TRIGger:UART:TYPE.....	452
TRIGger:WIDTh:DELTA.....	319
TRIGger:WIDTh:MAX.....	320
TRIGger:WIDTh:MIN.....	320
TRIGger:WIDTh:POLarity.....	319
TRIGger:WIDTh:RANGe.....	319
TRIGger:WIDTh:WIDTh.....	319
TRIGger:WINDow:DELTA.....	338
TRIGger:WINDow:MAXWidth.....	339
TRIGger:WINDow:MINWidth.....	339
TRIGger:WINDow:RANGe.....	338
TRIGger:WINDow:TIME.....	337

TRIGger:WINDow:WIDTh.....	338
UAPP:PATH.....	509
UAPP:PERSiStence.....	509
ZOOM:ENABle.....	339
ZOOM:POSiTion.....	340
ZOOM:SCALe.....	340